

6204 - 2 Z

SKF Explorer

Dimensions

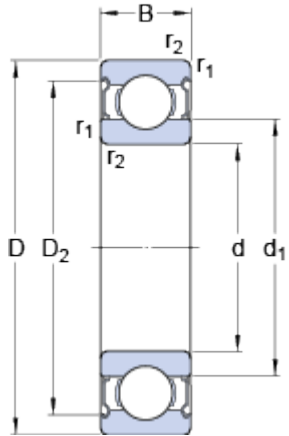

d	20	mm
D	47	mm
B	14	mm
d ₁	≈ 28.8	mm
D ₂	≈ 40.59	mm
r _{1,2}	min. 1	mm

Abutment dimensions

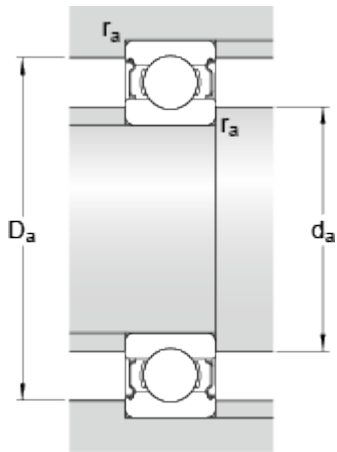

d _a	min. 25.6	mm
d _a	max. 28.7	mm
D _a	max. 41.4	mm
r _a	max. 1	mm

Calculation data

Basic dynamic load rating	C	13.5	kN
Basic static load rating	C ₀	6.55	kN
Fatigue load limit	P _u	0.28	kN
Reference speed		32000	r/min
Limiting speed		17000	r/min
Calculation factor	k _r	0.025	
Calculation factor	f ₀	13	

Mass

Mass bearing	0.11	kg
--------------	-------------	----

