

609 - 2 RSH

SKF Explorer

Dimensions

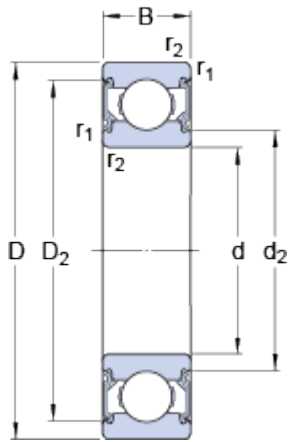

d	9	mm
D	24	mm
B	7	mm
d ₂	≈ 12.85	mm
D ₂	≈ 21.2	mm
r _{1,2}	min. 0.3	mm

Abutment dimensions

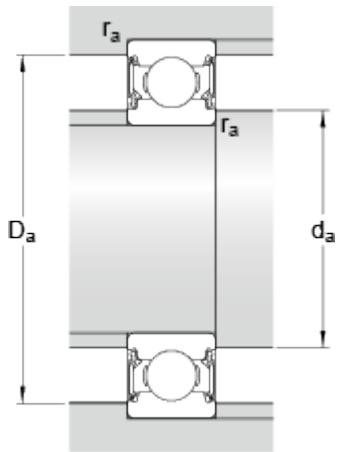

d _a	min. 11	mm
d _a	max. 12.5	mm
D _a	max. 22	mm
r _a	max. 0.3	mm

Calculation data

Basic dynamic load rating	C	3.9	kN
Basic static load rating	C ₀	1.66	kN
Fatigue load limit	P _u	0.071	kN
Limiting speed		19000	r/min
Calculation factor	k _r	0.025	
Calculation factor	f ₀	13	

Mass

Mass bearing		0.015	kg
--------------	--	--------------	----

