

6013 - 2 RS 1

SKF Explorer

Dimensions

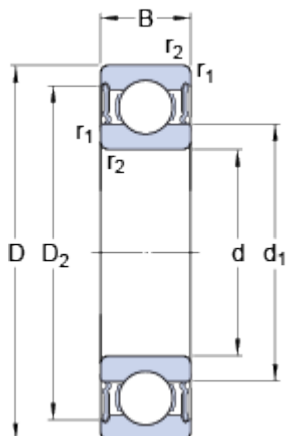

d	65	mm
D	100	mm
B	18	mm
d ₁	≈ 76.3	mm
D ₂	≈ 91.5	mm
r _{1,2}	min. 1.1	mm

Abutment dimensions

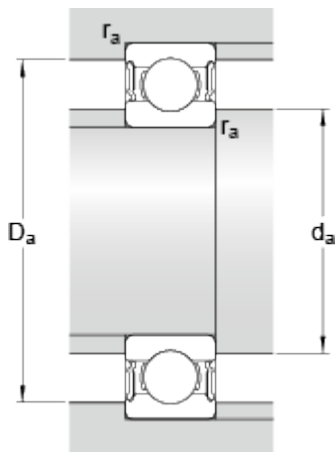

d _a	min. 71	mm
d _a	max. 76.2	mm
D _a	max. 94	mm
r _a	max. 1	mm

Calculation data

Basic dynamic load rating	C	31.9	kN
Basic static load rating	C ₀	25	kN
Fatigue load limit	P _u	1.06	kN
Limiting speed		4000	r/min
Calculation factor	k _r	0.025	
Calculation factor	f ₀	15.8	

Mass

Mass bearing		0.45	kg
--------------	--	-------------	----

