

51118

Dimensions

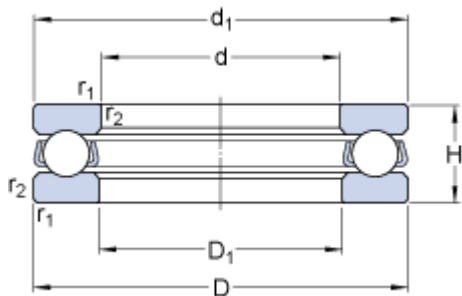

d	90	mm
D	120	mm
H	22	mm
d ₁	≈ 120	mm
D ₁	≈ 92	mm
r _{1,2}	min. 1	mm

Abutment dimensions

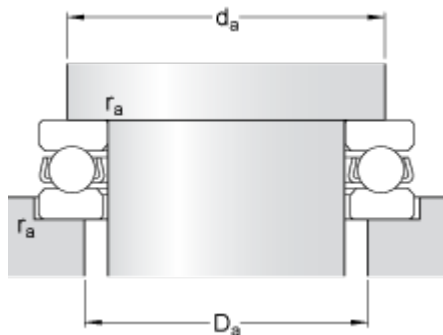

d _a	min. 108	mm
D _a	max. 102	mm
r _a	max. 1	mm

Calculation data

Basic dynamic load rating	C	59.2	kN
Basic static load rating	C ₀	208	kN
Fatigue load limit	P _u	7.5	kN
Reference speed		2600	r/min
Limiting speed		3800	r/min
Minimum load factor	A	0.22	

Mass

Mass bearing (including seat washer where applicable)	0.67	kg
---	-------------	----