

BN 117 - DIN 934 - ~ISO 4032

Hexagon nuts ~0,8d

DIN 934
~ISO 4032
~UNI 5588

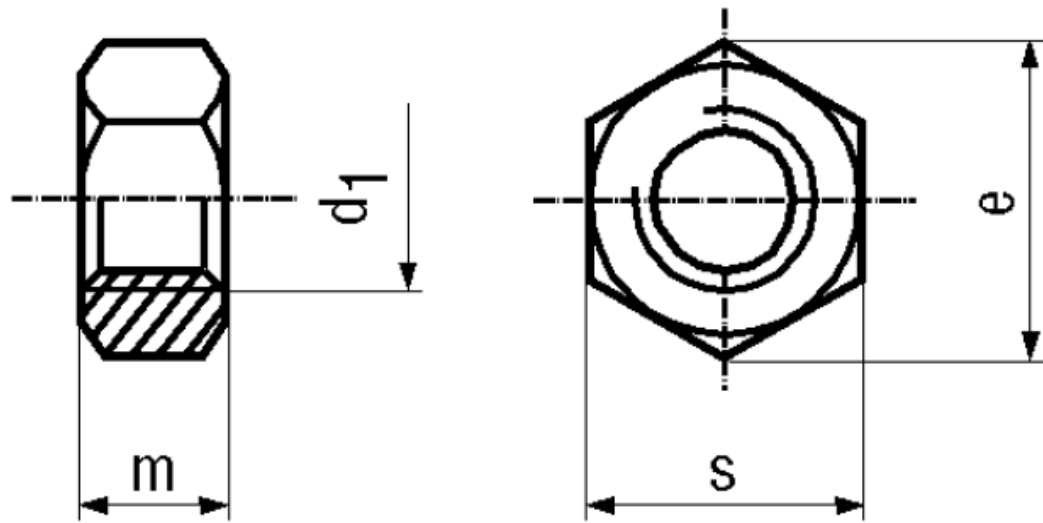

Material	Steel	Quality	cl. 8
Surface	zinc plated blue		

Article No. - 1874713	
d_1	M5
e min.	8,79
s	8
m max.	4

DIN 934: Standard withdrawn
M10, M12, M14, M22: Wrench size according to ISO 272.