

BN 508 - DIN 439 B - ~ISO 4035

Hexagon nuts ~0,5d

DIN 439 B
~ISO 4035
~UNI 5589

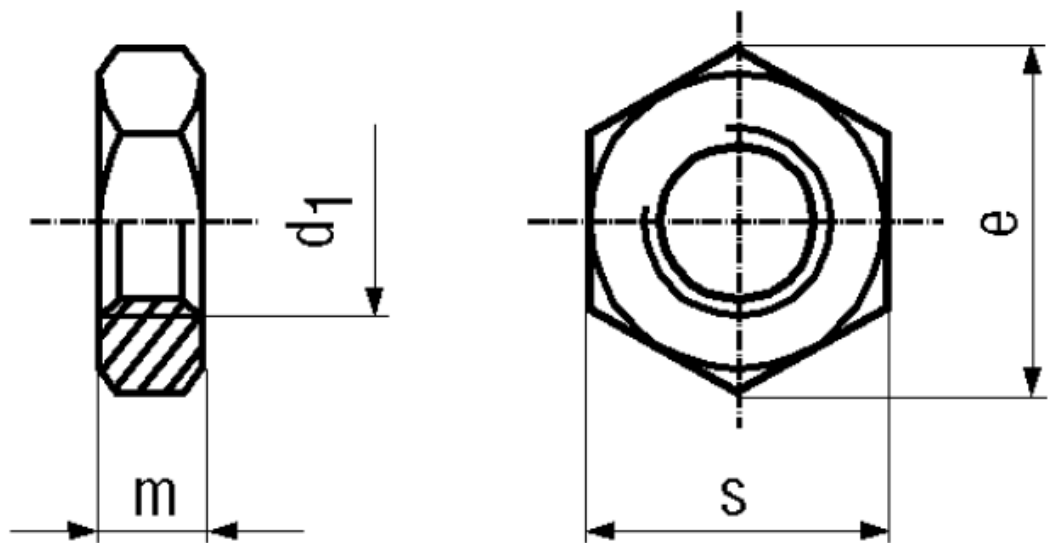

Material Surface

Article No. - 1440004

d_1	M2
e min.	4,38
s	4
m max.	1,2

DIN 439: Standard withdrawn

M7: Not included in DIN 439.

Wrench size according to ISO on request.