

* = Conical form tapering downward.
 Untoleranced dimensions per DIN 16901-140

OPTIONAL ACCESSORIES		
PART NAME	QTY	AVAILABILITY
MOUNTING PLATE	1	Y
EXTERNAL HINGE	1	Y
INTERNAL HINGE	-	N
MOUNTING BRACKETS	4	Y
NEOPRENE/SILICON GASKET	1	Y
DIN RAIL TS15	-	N
DIN RAIL TS35	1	Y

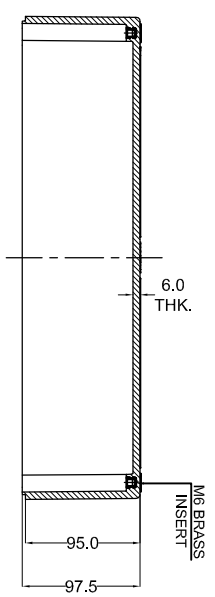
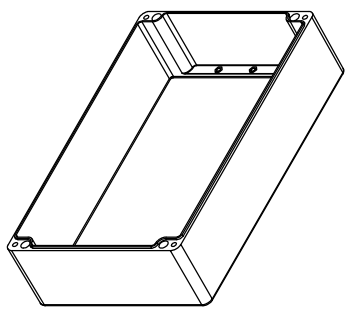
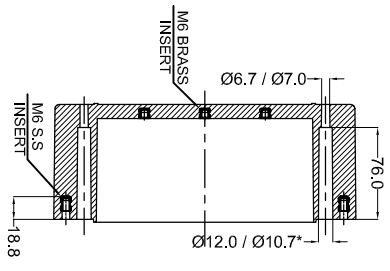
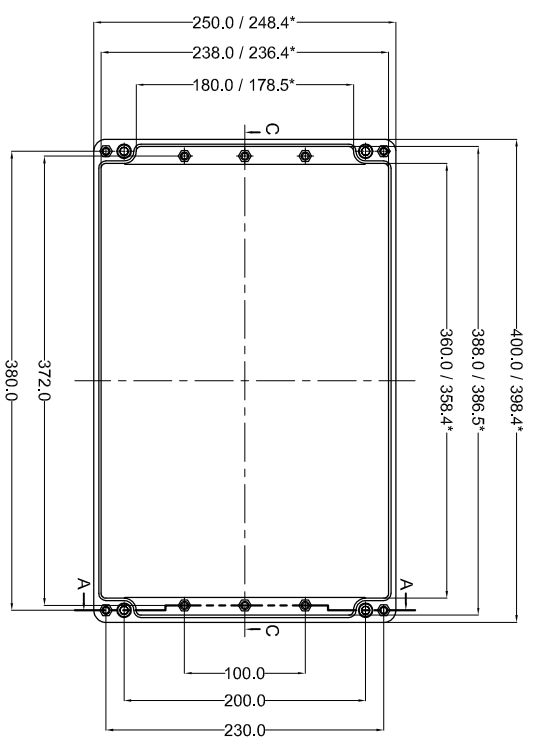
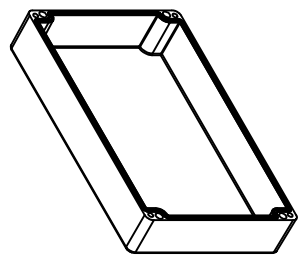
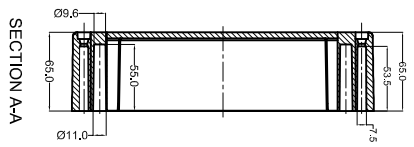
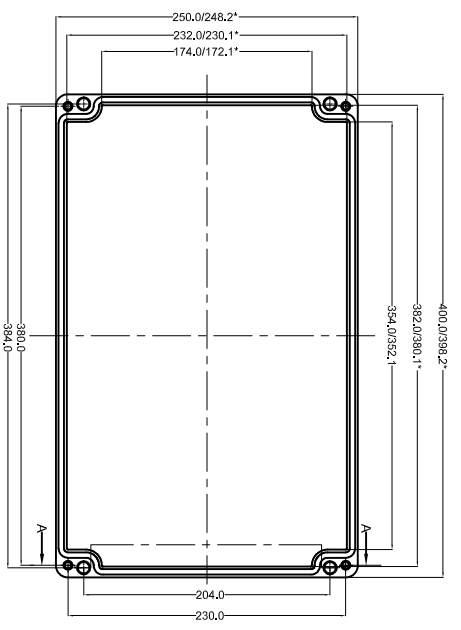

SECTION A-A

SECTION C-C

Sr.No.	Drawing no.	RM Grade	Finish
2	GJB-400250120-02	GRP-30	BLACK RAL9011
1	GJB-400250120-01	GRP-23	GREY RAL7000

NO. / REV. NO.	DESCRIPTION	DATE	DRAWN	CHECKED

QUANTITY	MATERIAL :-	MACH. NAME	DATE	SIGN	NAME
	GRP		09/01/14		ERP L DESIGN
			09/01/14		MANOJ DRAWN
					PAVAN CHECKED
					I.E.S. APPROVED

TOLERANCE	WEIGHT	FINISH	SCALE	PARTNO.
±0.2				
±1.0°				

TITLE :-	RAYCHEM RPP (P) LIMITED	DRG. NO.
GRP JUNCTION BOX	Ceat Mahal Annex, Dr. Arnie Bessant Road, Ward, Mumbai 400030 Web : www.raychemrpp.com	GJB-400250160-0

PROPERTY OF RaychemRPP (P) LTD.
 ALL RIGHTS RESERVED AND/OR PHOTOCOPIING THIS DOCUMENT
 TO A PERSON WITHOUT RaychemRPP (P) LTD. WRITTEN AUTHORIZATION IS PROHIBITED