

SECTION A-A

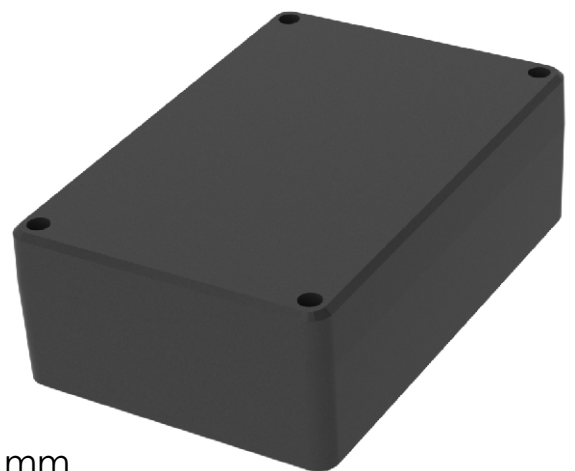

Dimensional tolerance $\pm 0,5$ mm

- Components:
- body
 - cover
 - 4x M3
 - gasket

| | |
|-----------------------|--------------|
| Format A4 | Scale 1:1 |
| Product No. KM-75I | |



MASZCZYK[®]
PLASTIC ENCLOSURES

„MASZCZYK”
05-071 Sulejówek-Miłosna
ul. Mickiewicza 10
tel: (22) 783-45-20 kom: 602-726-086

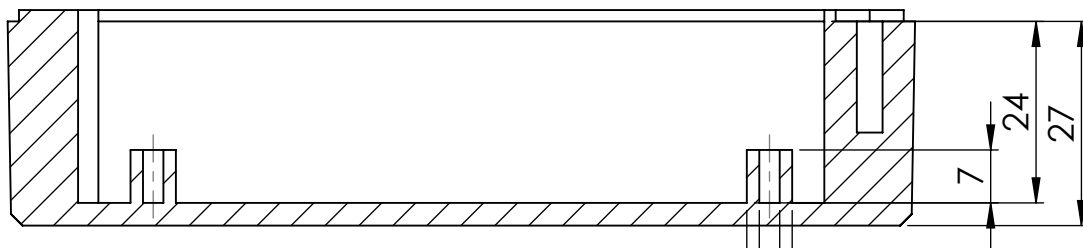
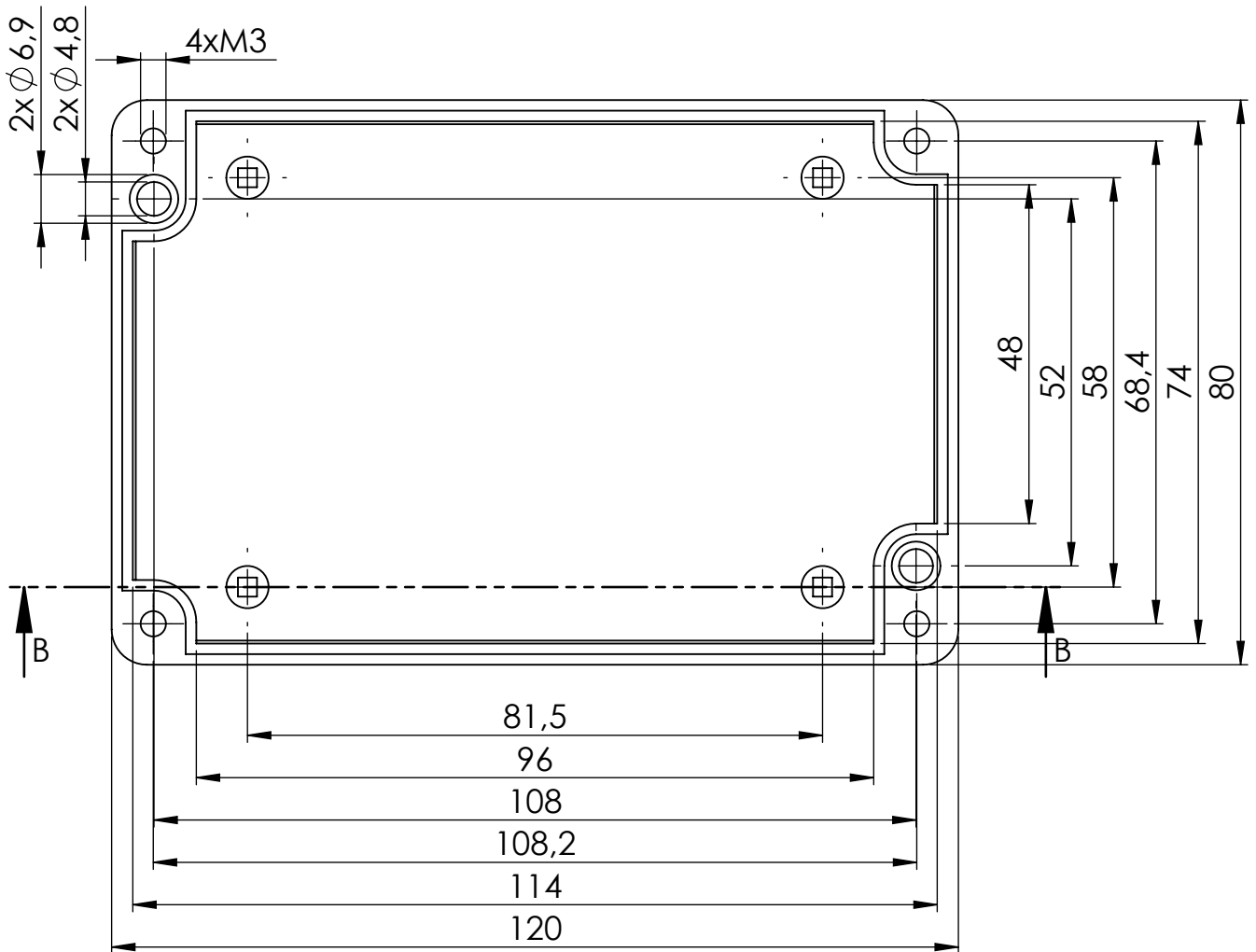

SECTION B-B

4x □ 2,7
4x Ø 6

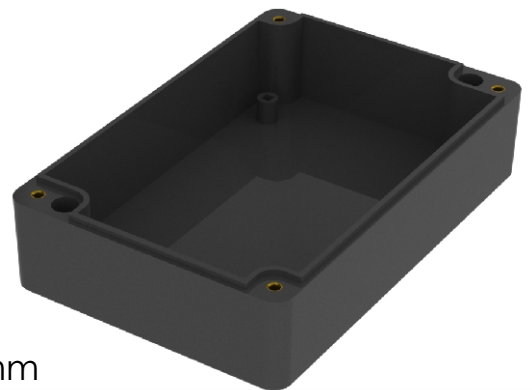

Dimensional tolerance $\pm 0,5$ mm

| | |
|------------------------------|--------------|
| Format A4 | Scale 1:1 |
| Product No. KM-75I (body) | |



MASZCZYK[®]
PLASTIC ENCLOSURES

„MASZCZYK”
05-071 Sulejówek-Miłosna
ul. Mickiewicza 10
tel: (22) 783-45-20 kom: 602-726-086

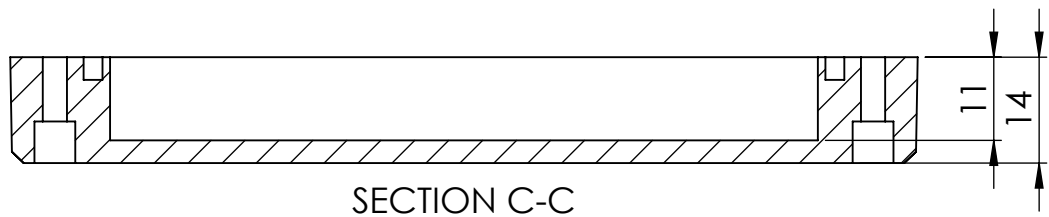
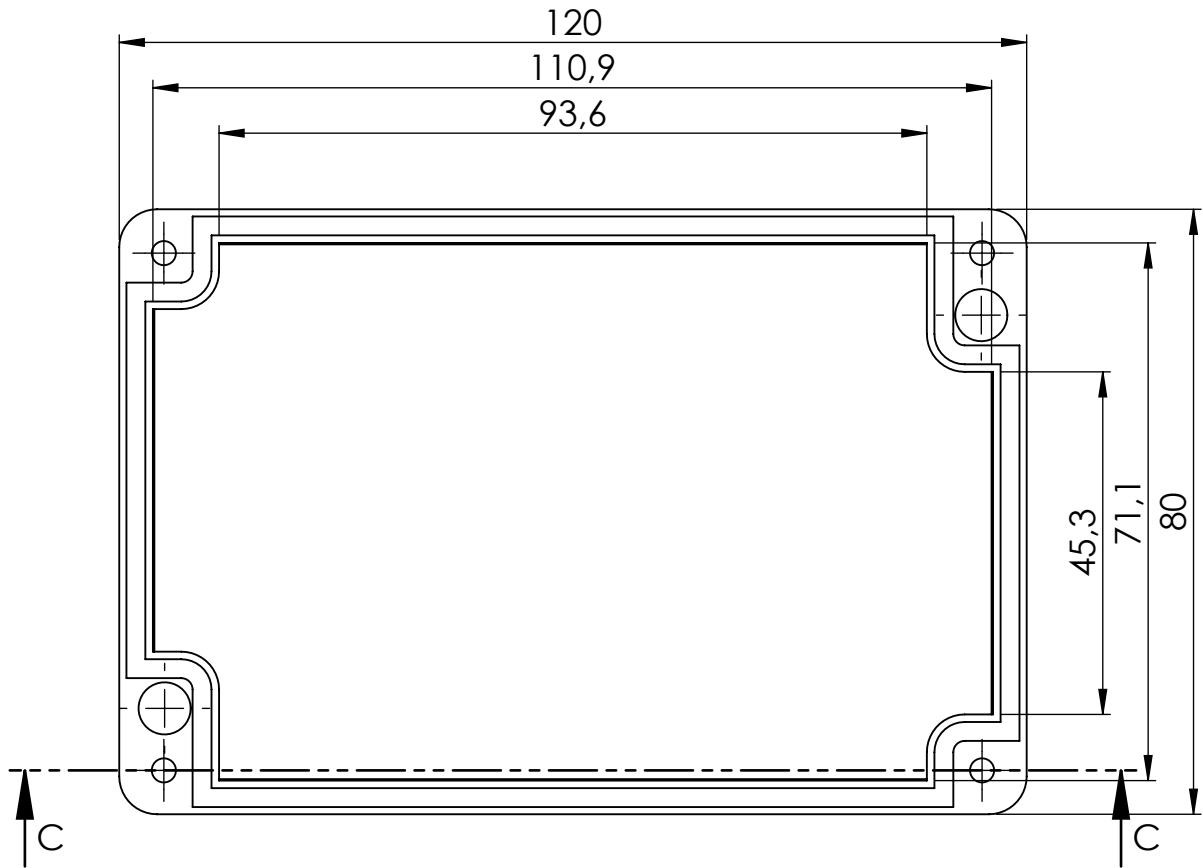

SECTION C-C

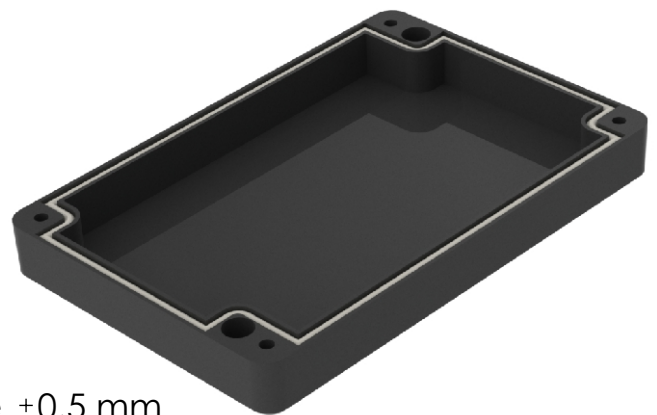

Dimensional tolerance $\pm 0,5$ mm

| | |
|-------------------------------|--------------|
| Format A4 | Scale 1:1 |
| Product No. KM-75I (cover) | |



MASZCZYK[®]
PLASTIC ENCLOSURES

„MASZCZYK”
05-071 Sulejówek-Miłosna
ul. Mickiewicza 10
tel: (22) 783-45-20 kom: 602-726-086