

All rights reserved, Copyright Kradex 2016		
Product model	Enclosure Z90 - assembly	
Format: A3	Material: PS, ABS	
Scale 1:2	Tolerance: +/- 0.5	

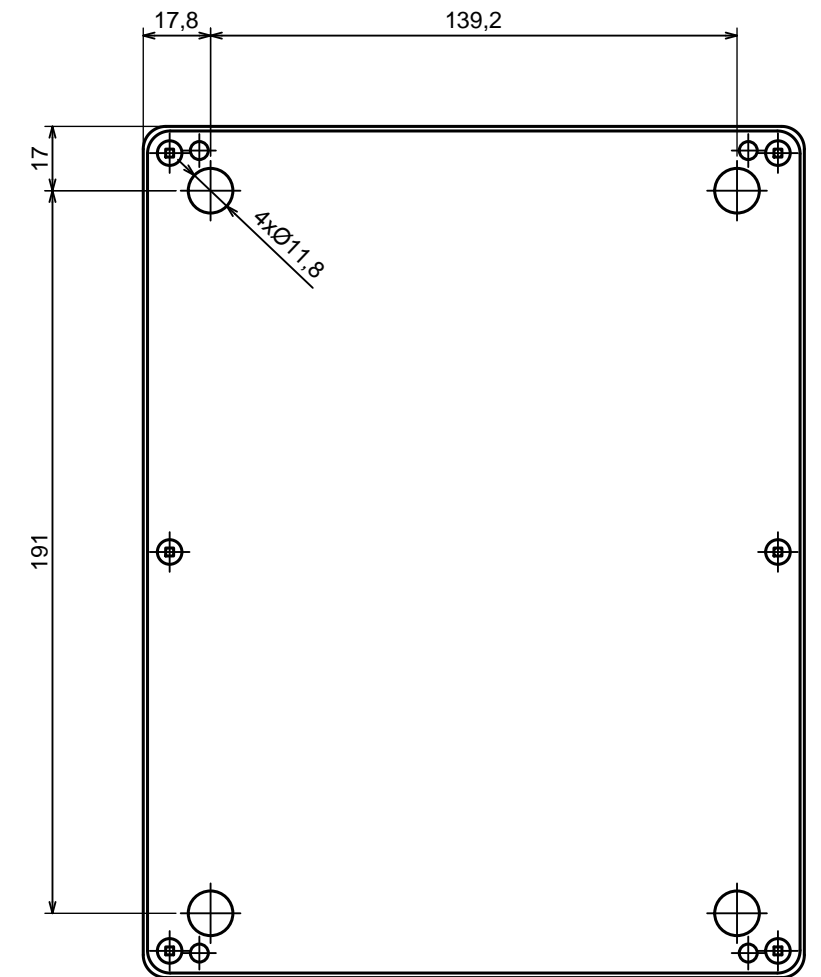
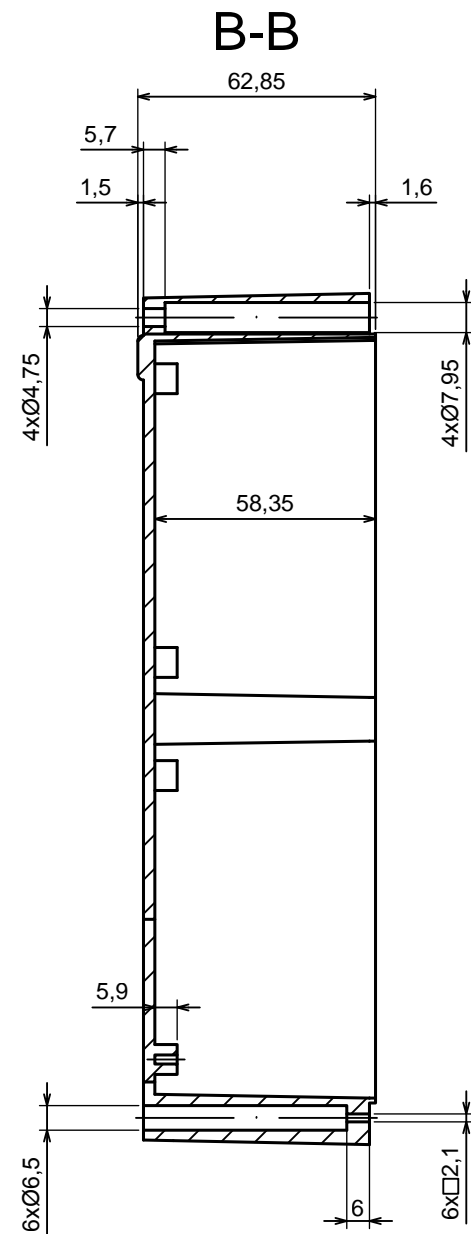
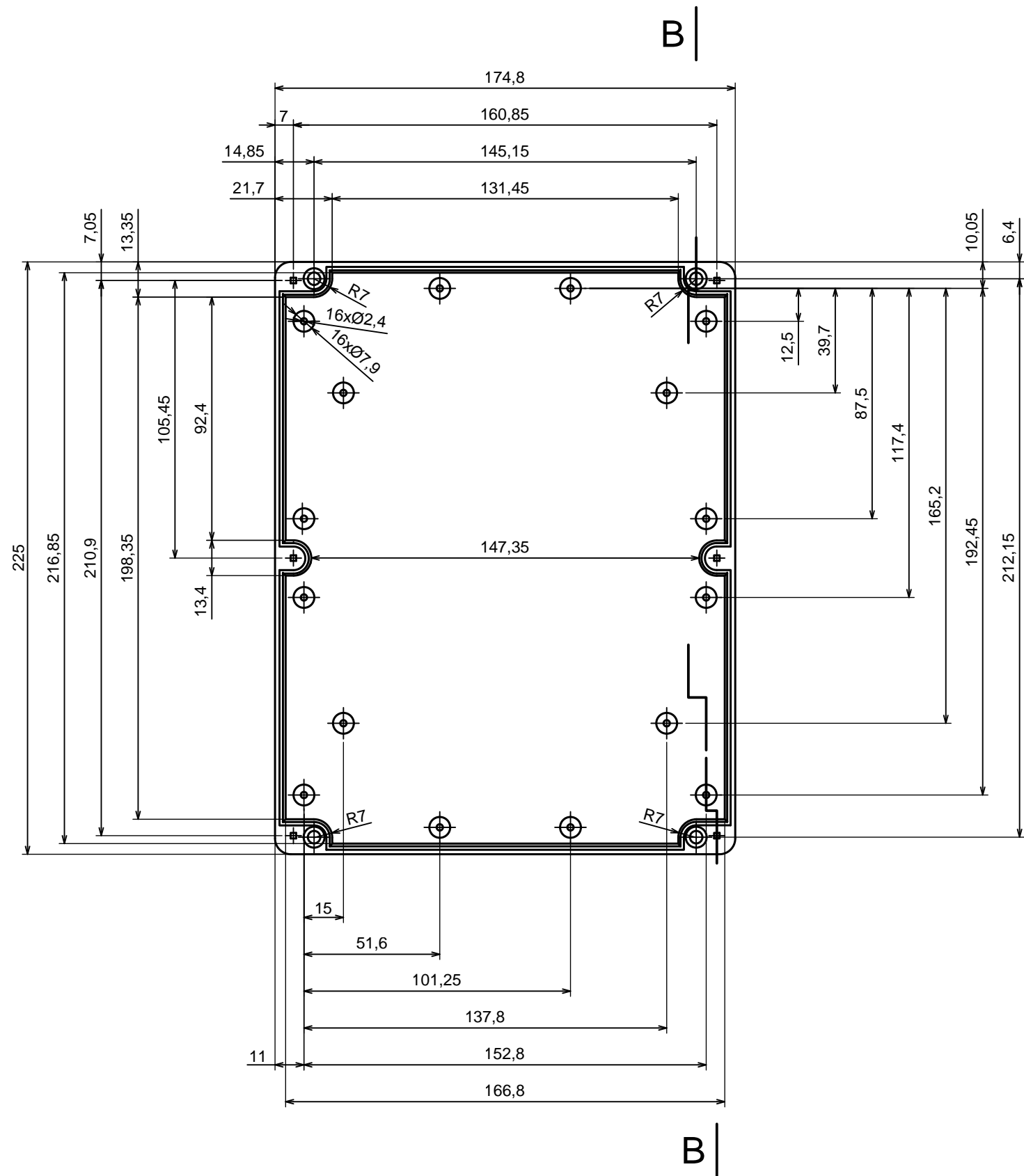

All rights reserved, Copyright Kradox 2016

Product model Enclosure Z90 - base

Format: A3 Material: PS, ABS

Scale 1:2 Tolerance: +/- 0.5



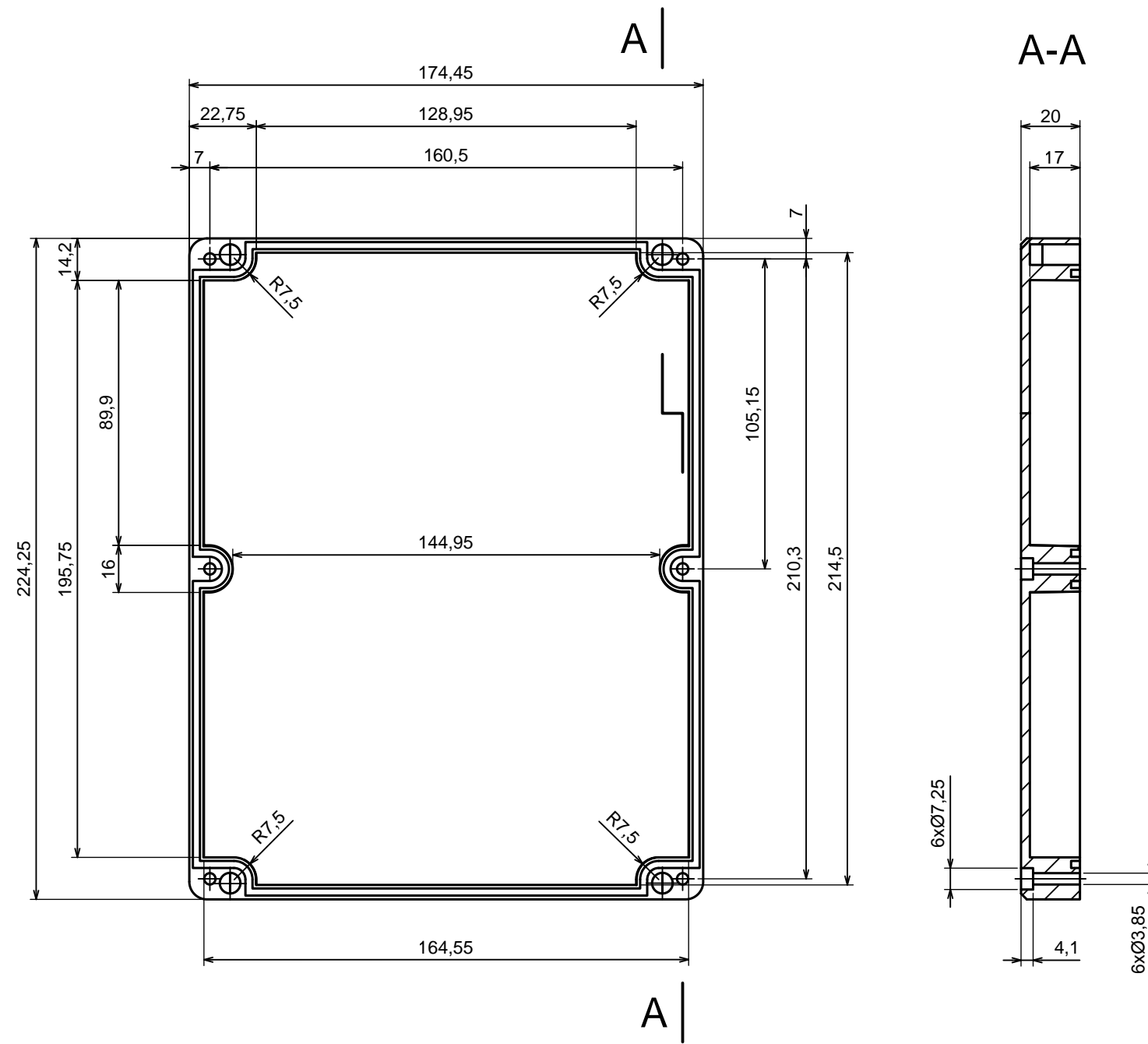

All rights reserved, Copyright Kradox 2016

Product model: Enclosure Z90 - cover

Format: A3 Material: PS, ABS

Scale 1:2 Tolerance: +/- 0.5

