

Bottom View of Assembly

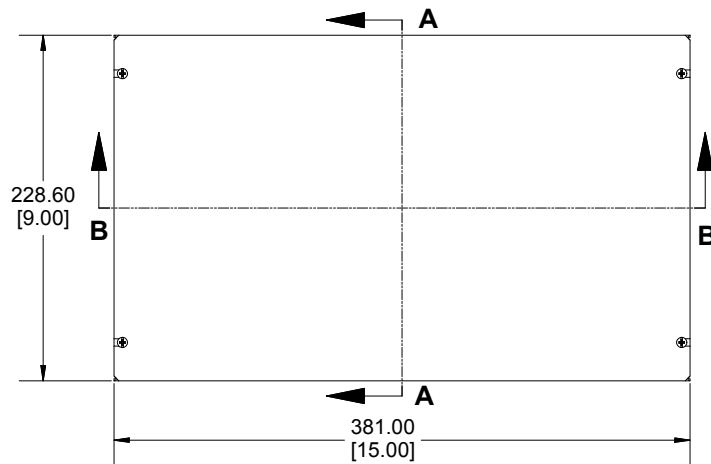

**SECTION A-A
End View of Assembly**

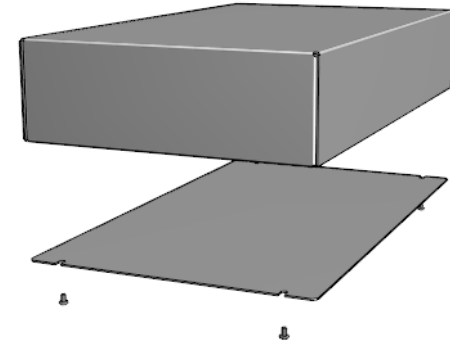
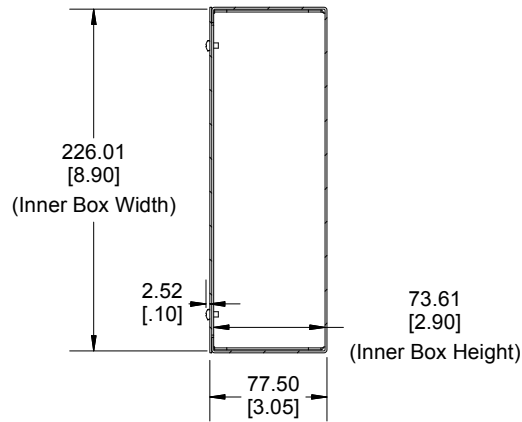

**Bottom View of Chassis
(Sold Separately)**

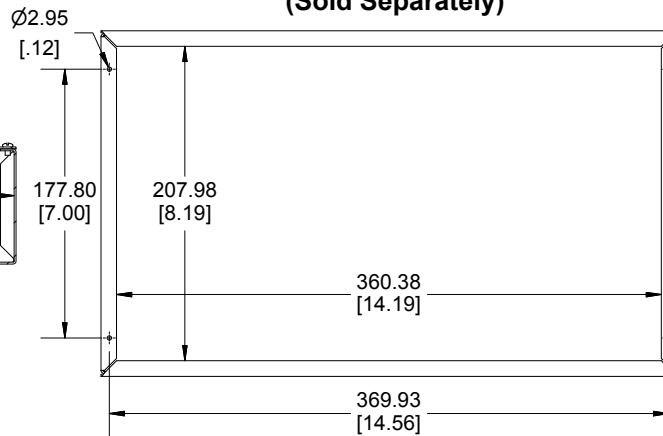

**SECTION B-B
Side View of Assembly**

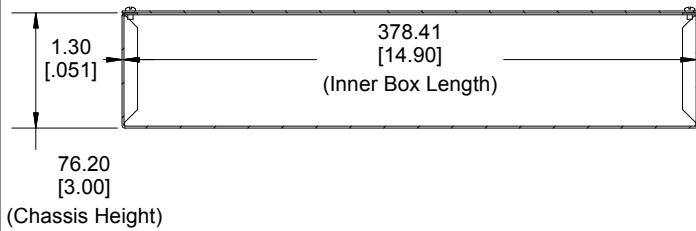

**Bottom Plate
(Sold Separately)**

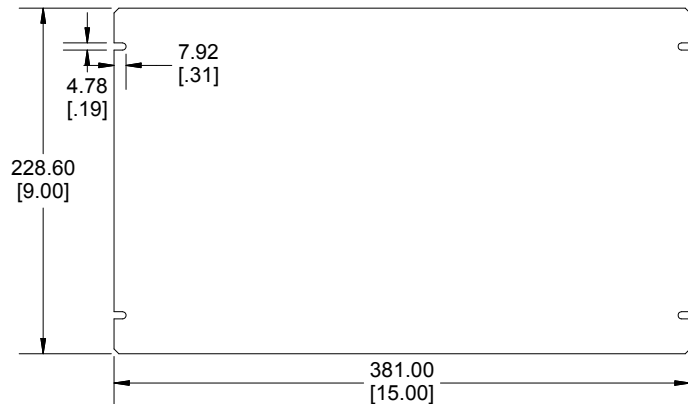

Enclosures can be Factory Modified (Milling, Drilling, Printing etc.)
Contact Factory mjm@hammondmfg.com for quotes
Solid models of this enclosure available in STEP or IGES.

NOTE

All Components Sold Separately
Chassis is Made of 0.051" Aluminum.
Bottom Plate is Made of 0.051" Aluminum.

PART NUMBERS

1444-1593 Enclosure

Natural Finish Chassis

1444-1593

ACCESSORIES

Natural Finish Bottom Plate

1434-159

Plated Cover Screws (Pkg 6)

1421J6

[6-32 x 1/4" Self-Tapping Screws]

**HAMMOND
MANUFACTURING™**
1444-1593
www.hammondmfg.com

Dimensions:
mm
[inches]