

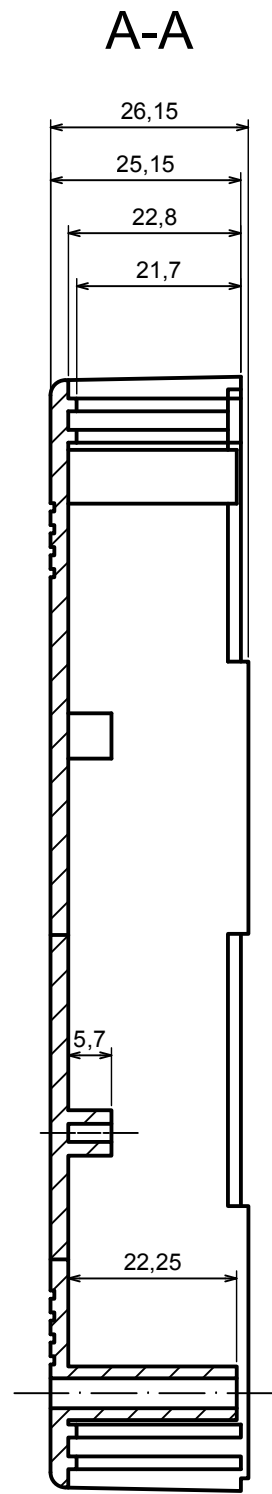

All rights reserved, Copyright Kradox 2017		
Product model	Enclosure Z50B - Assembly	
Format: A3	Material: PS, ABS	
Scale 1:1	Tolerance: +/- 0.8	

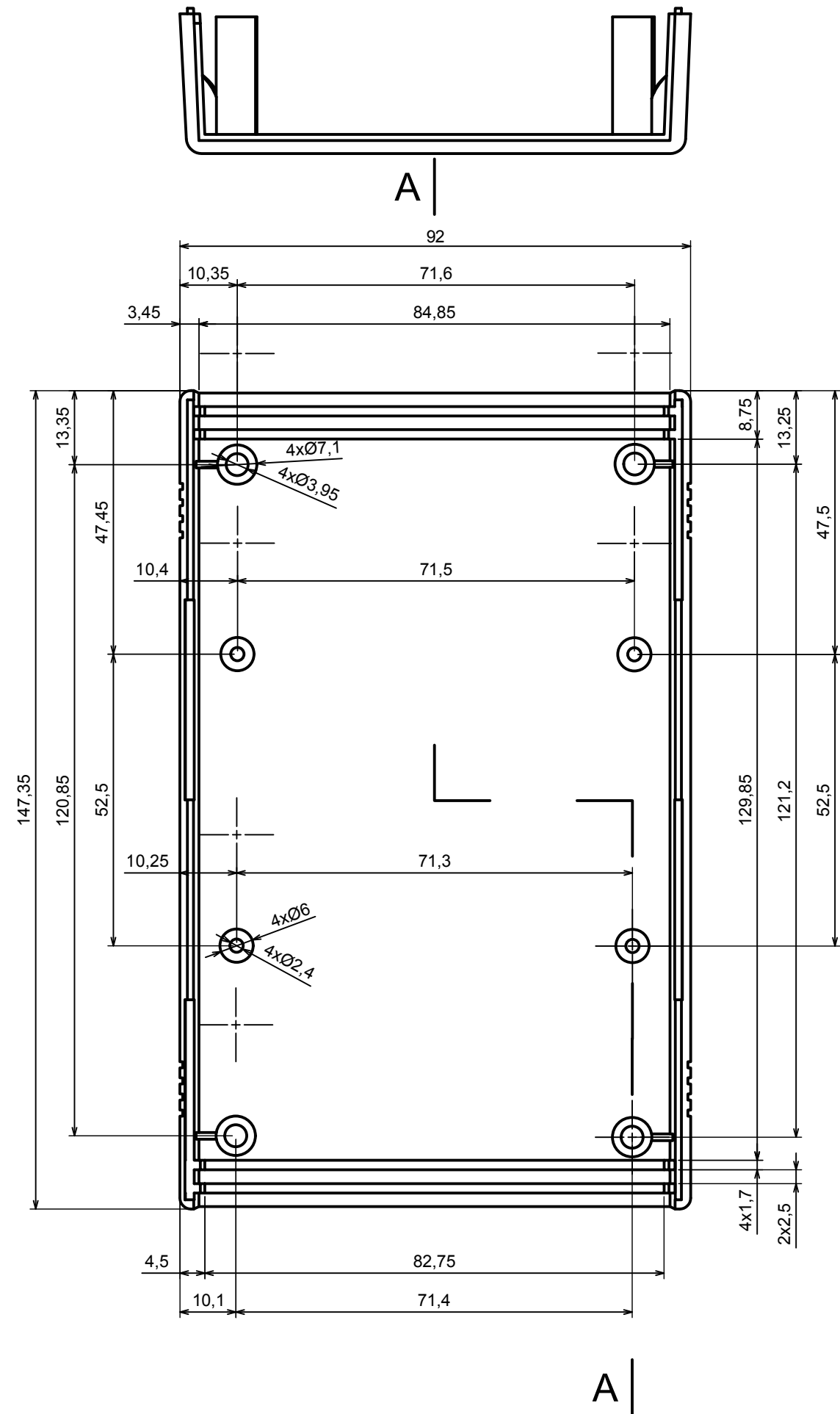

All rights reserved, Copyright Kradox 2017		
Product model	Enclosure Z50B - Base	
Format: A3	Material: PS, ABS	
Scale 1:1	Tolerance: +/- 0.8	

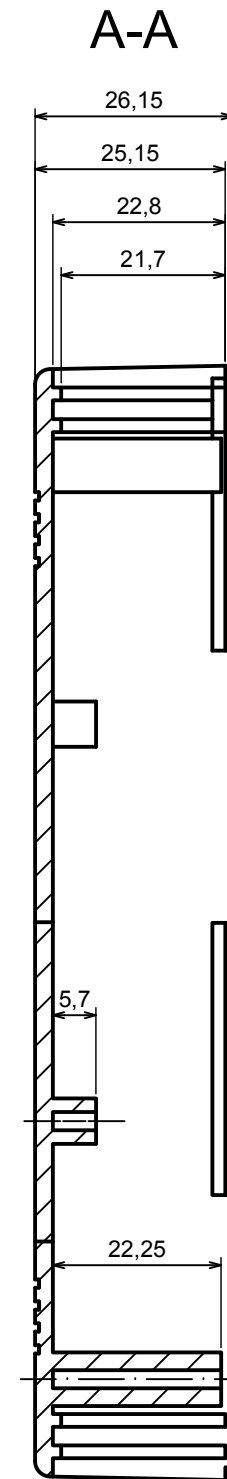
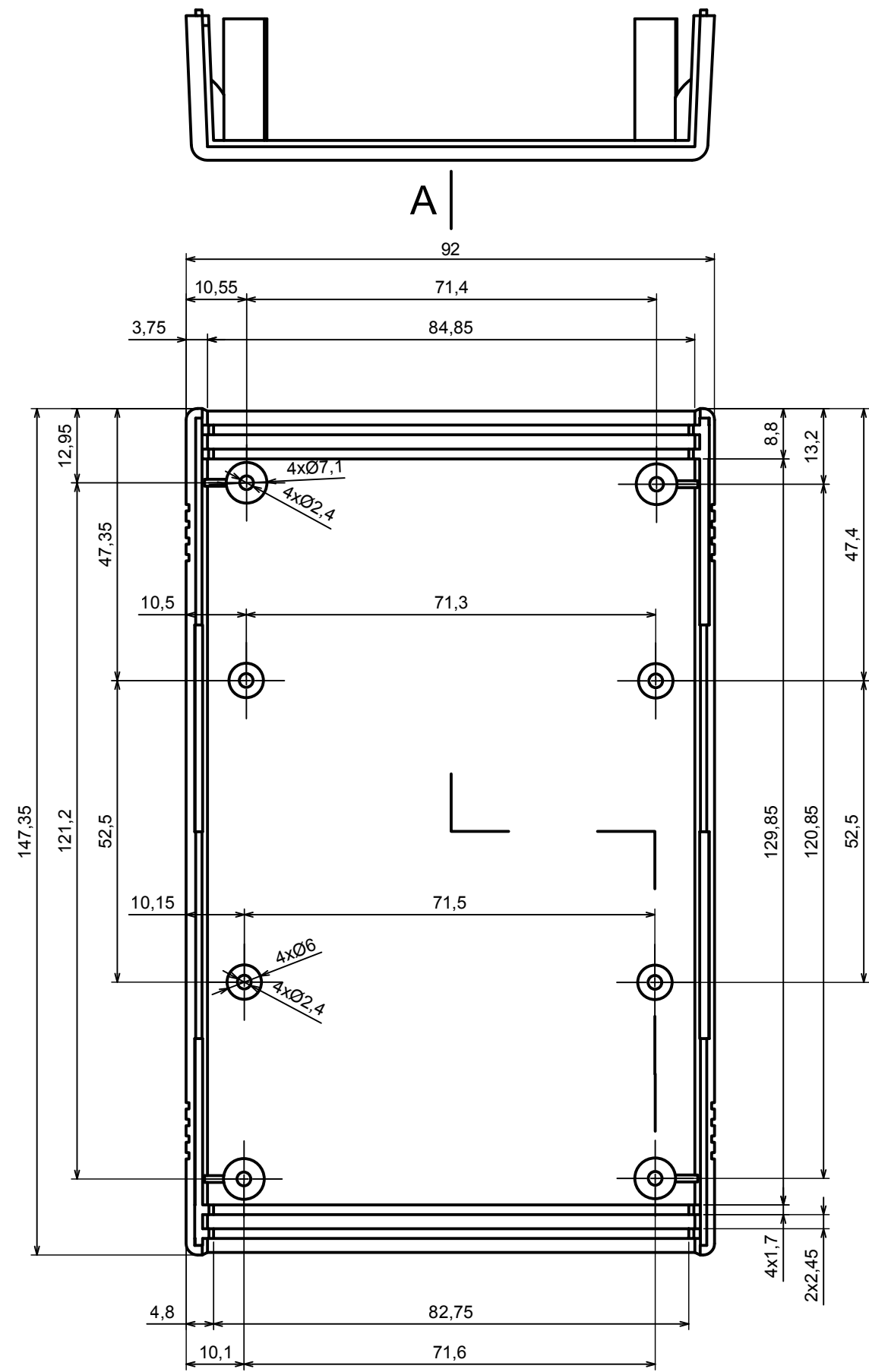

All rights reserved, Copyright Kradox 2017

Product model: Enclosure Z50B - Cover

Format: A3 Material: PS, ABS

Scale 1:1 Tolerance: +/- 0.8



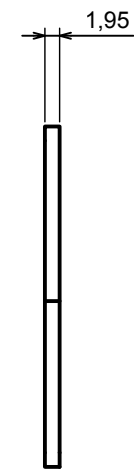
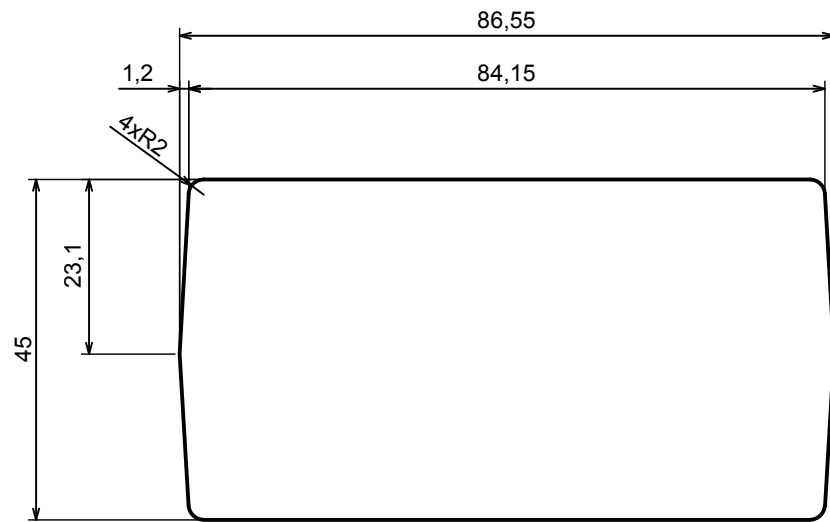

All rights reserved, Copyright Kradex 2017		
Product model	Enclosure Z50B - Board	
Format: A3	Material: PS, ABS	
Scale 1:1	Tolerance: +/- 0.8	

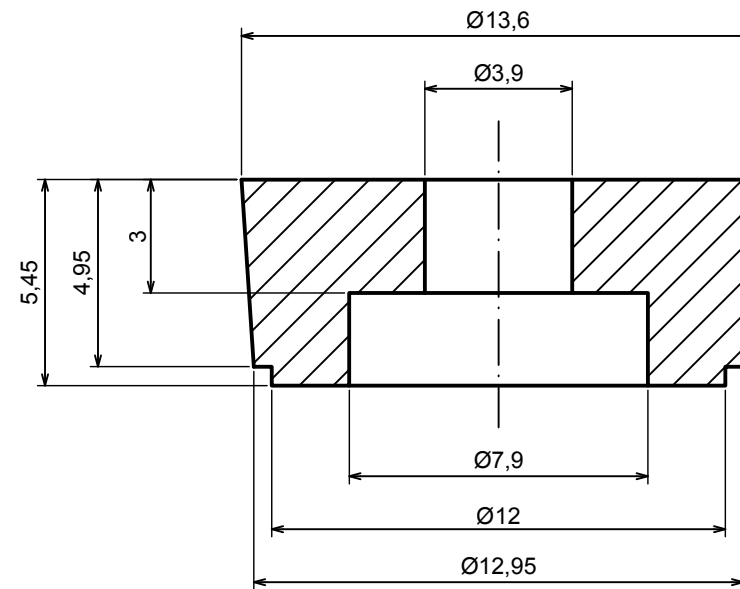

All rights reserved, Copyright Kradox 2017

Product model: Enclosure Z50B - Foot

Format: A3      Material: PS, ABS

Scale 5:1      Tolerance: +/- 0.5

