

Features

Regulated Converter

- Reinforced insulation for 250VAC working voltage
- Clearance and creepage distance >8.0mm
- 5kVAC I/P to O/P 2MOPP isolation
- 2µA patient leakage current
- Industry standard pinout
- 4:1 wide input range



REM15-W

15 Watt
4:1 Input
1.6" x 1"
Single and Dual Output



UL60950-1 certified
 CSA/CAN C22.2 60950-1-07 certified
 UL62368-1 certified
 CSA/CAN C22.2 62368-1 certified
 CSA/CAN C22.2 60601-01 certified
 ANSI/AAMI ES60601-1 certified
 EN55011 certified
 CB report

Description

The REM15-W series of medical grade regulated DC/DC converters features reinforced 5kVAC/1 minute isolation with low 2µA leakage (B, BF and CF compatible) and are 60601-1 3rd Ed. certified for 250VAC continuous working voltage isolation. The industry standard 1.6"x1" package offers tightly regulated single and dual outputs, with low output ripple and zero-load operation. The outputs are also short circuit and overload protected. The converters are certified to CB, IEC/EN and ANSI/AAMI standards and carry the UL mark.

Selection Guide

Part Number	Input Voltage Range [VDC]	Output Voltage [VDC]	Output Current [mA]	Efficiency typ. ⁽¹⁾ [%]	Max. Capacitive Load ⁽²⁾ [µF]
REM15-2405SW ⁽³⁾	9-36	5	3000	87	3800
REM15-2412SW ⁽³⁾	9-36	12	1250	88.5	650
REM15-2415SW ⁽³⁾	9-36	15	1000	88	530
REM15-2424SW ⁽³⁾	9-36	24	625	88	190
REM15-2405DW ⁽³⁾	9-36	±5	±1500	86	±1900
REM15-2412DW ⁽³⁾	9-36	±12	±625	88	±380
REM15-2415DW ⁽³⁾	9-36	±15	±500	88	±270
REM15-4805SW ⁽³⁾	18-75	5	3000	89.5	3800
REM15-4812SW ⁽³⁾	18-75	12	1250	88	650
REM15-4815SW ⁽³⁾	18-75	15	1000	88	530
REM15-4824SW ⁽³⁾	18-75	24	625	88.5	190
REM15-4805DW ⁽³⁾	18-75	±5	±1500	86	±1900
REM15-4812DW ⁽³⁾	18-75	±12	±625	88.5	±380
REM15-4815DW ⁽³⁾	18-75	±15	±500	88	±270

Notes:

Note1: Efficiency is tested at nominal input and full load at +25°C ambient
 Note2: Max Cap Load is tested at nominal input and full resistive load

Model Numbering



Notes:

Note3: standard is with suffix „/P“ (CTRL pin with positive logic)
 without suffix is without CTRL pin (no pin) please refer to **“Dimension Drawing (mm)”**

Ordering Examples:

REM15-2412SW/P = 4:1 Input, 9-36Vin, 12Vout, with control pin positive logic
 REM15-4815DW = 4:1 Input, 18-75Vin, ±15Vout, without control pin

Specifications (measured @ Ta= 25°C, nominal input voltage, full load and after warm-up)

BASIC CHARACTERISTICS					
Parameter	Condition		Min.	Typ.	Max.
Internal Input Filter			Pi type		
Input Voltage Range	nom. Vin= 24VDC		9VDC	24VDC	36VDC
	nom. Vin= 48VDC		18VDC	48VDC	75VDC
Input Surge Voltage	3 second max.	nom. Vin= 24VDC			50VDC
		nom. Vin= 48VDC			100VDC
Under Voltage Lockout	nom. Vin= 24VDC	DC-DC ON DC-DC OFF	7.8VDC		8.6VDC
	nom. Vin= 48VDC	DC-DC ON DC-DC OFF	15.8VDC		17.4VDC
Quiescent Current	nom. Vin= 24VDC			13mA	
	nom. Vin= 48VDC			10mA	
Output Voltage Trimming	5Vout, 12Vout		-10%		+10%
	15Vout, 24Vout		-10%		+20%
Minimum Load			0%		
Start-up Time	ON/OFF CTRL			10ms	60ms
	Power up			30ms	60ms
ON/OFF CTRL ⁽⁴⁾	DC-DC ON		Open or 3.5VDC - 12VDC		
	DC-DC OFF		Short or 0VDC - 1.2VDC		
Input Current off CTRL Pin	DC-DC ON		-0.5mA		1mA
Standby Current	DC-DC OFF			2.5mA	
Internal Operating Frequency			220kHz	250kHz	300kHz
Output Ripple and Noise (20MHz BW)	with a 10µF X7R/MLCC	5Vout, single and dual		50mVp-p	
		12 & 15Vout, single and dual		75mVp-p	
	with a 4.7µF X7R/MLCC	24Vout single		100mVp-p	

Notes:

Note4: The ON/OFF control function is positive logic. The pin voltage is referenced to -Vin pin

Efficiency vs. Load

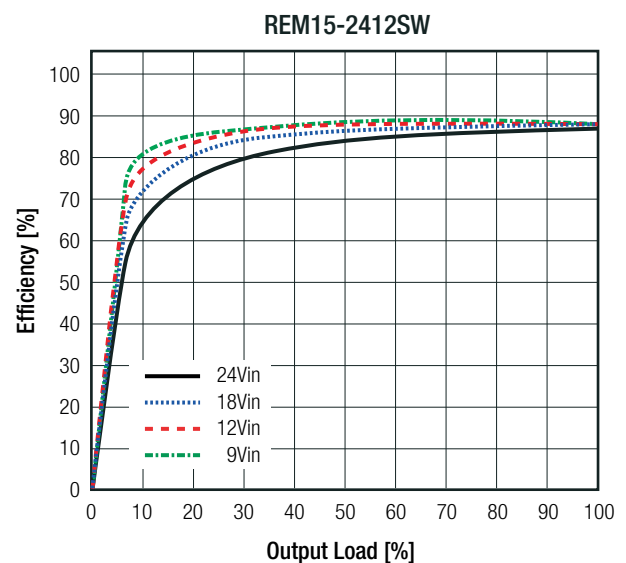
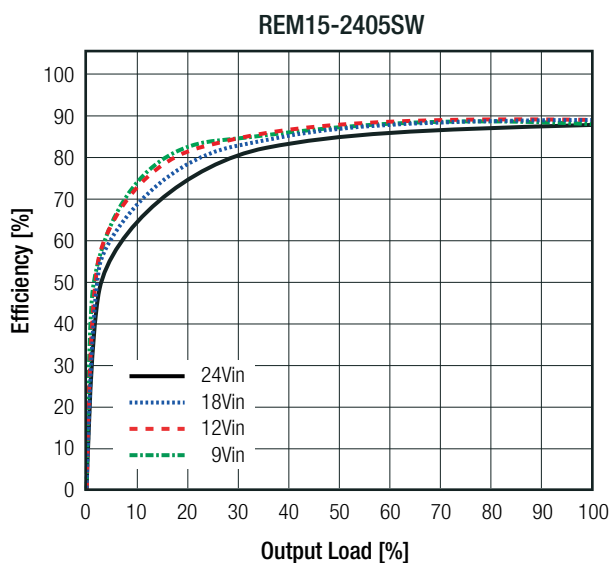

continued on next page

Specifications (measured @ $T_a = 25^\circ\text{C}$, nominal input voltage, full load and after warm-up)

Efficiency vs. Load

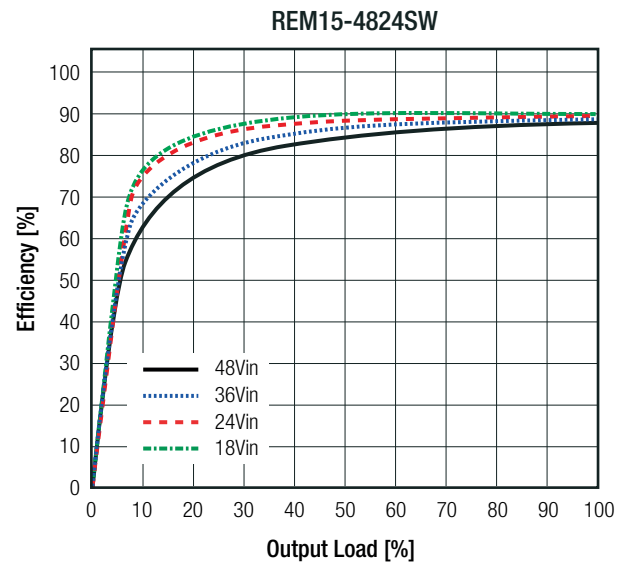
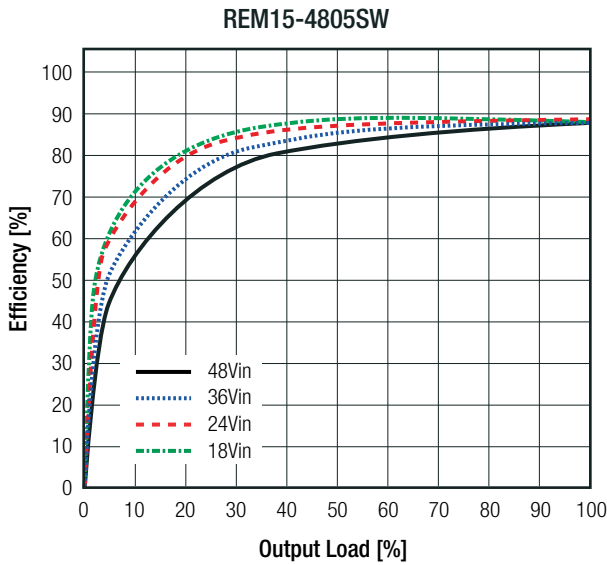

Power Dissipation vs. Load

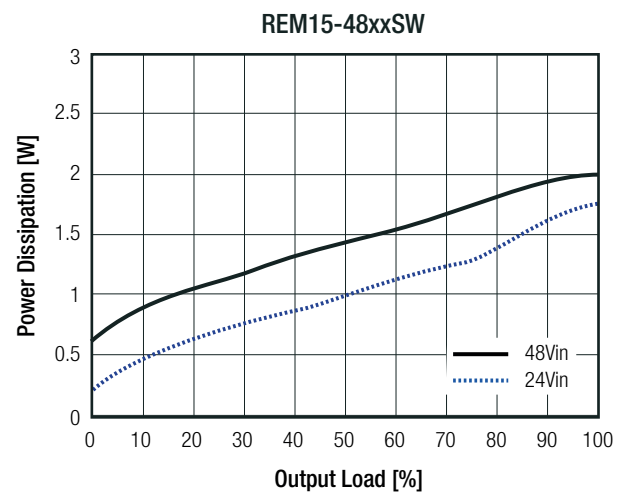
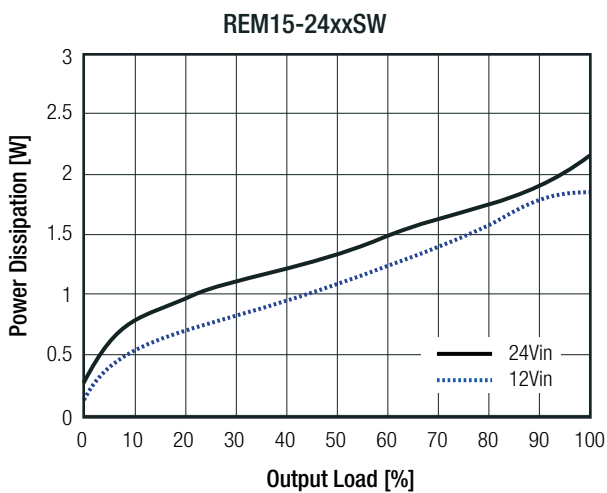

Output Voltage Trimming

It allows the user to increase or decrease the output voltage of the module. This is accomplished by connecting an external resistor between the Trim pin and either the +Vout or -Vout pins. With an external resistor between the Trim and -Vout pin, the output voltage increases. With an external resistor between the Trim and +Vout pin, the output voltage decreases. The external Trim resistor needs to be at least 1/16W of rated. The values for trim resistors shown in trim tables below are according to standard E96 values; therefore, the specified voltage may slightly vary.

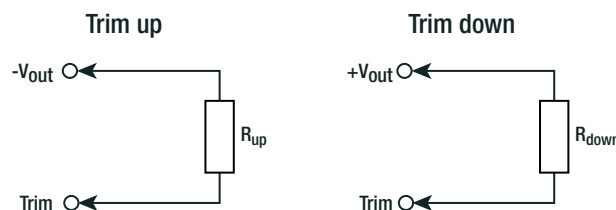

continued on next page

Specifications (measured @ Ta= 25°C, nominal input voltage, full load and after warm-up)

Trim Calculation

- V_{out_nom} = nominal output voltage [VDC]
- V_{out_set} = trimmed output voltage [VDC]
- V_{ref} = reference voltage [VDC]
- R_{up} = trim up resistor [Ω]
- R_{down} = trim down resistor [Ω]
- R₁ & R₂ = internal resistors [Ω]
- k_u = trim up factor []

V _{out_nom}	R ₁	R ₂	k _u	V _{ref}
5VDC	5k1Ω	2kΩ	2.5	2.5VDC
12VDC	10kΩ	5k1Ω	9.5	
15VDC	10kΩ	5k1Ω	12.5	
24VDC	56kΩ	13kΩ	21.5	

Calculation:

$$R_{up} = \left[\frac{R_1 \times V_{ref}}{V_{out_set} - V_{ref} - k_u} \right] - R_2$$

$$R_{down} = \left[\frac{(V_{out_set} - V_{ref}) \times R_1}{V_{out_nom} - V_{out_set}} \right] - R_2$$

Practical Example REM15-1205SW +10% / -10%:

$$R_{up} = \left[\frac{5k1 \times 2.5}{5.5 - 2.5 - 2.5} \right] - 2k = 23k5\Omega$$

$$R_{down} = \left[\frac{(4.5 - 2.5) \times 5k1}{5 - 4.5} \right] - 2k = 18k4\Omega$$

R_{up} according to E96 ≈ 23k7Ω

R_{down} according to E96 ≈ 18k2Ω

REM15-xx05SW(P)

Trim up	1	2	3	4	5	6	7	8	9	10	[%]
V _{out_set} =	5.05	5.10	5.15	5.20	5.25	5.30	5.35	5.40	5.45	5.50	[VDC]
R _{up} (E96) ≈	255k	127k	82k5	61k9	48k7	40k2	34k8	30k1	26k1	23k7	[Ω]

Trim down	1	2	3	4	5	6	7	8	9	10	[%]
V _{out_set} =	4.95	4.90	4.85	4.80	4.75	4.70	4.65	4.60	4.55	4.50	[VDC]
R _{down} (E96) ≈	249k	121k	78k7	56k2	44k2	35k7	29k4	24k9	21k	18k2	[Ω]

REM15-xx12SW(P)

Trim up	1	2	3	4	5	6	7	8	9	10	[%]
V _{out_set} =	12.12	12.24	12.36	12.48	12.60	12.72	12.84	12.96	13.08	13.20	[VDC]
R _{up} (E96) ≈	205k	100k	64k9	47k5	36k5	29k4	24k9	20k1	17k9	15k8	[Ω]

Trim down	1	2	3	4	5	6	7	8	9	10	[%]
V _{out_set} =	11.88	11.76	11.64	11.52	11.40	11.28	11.16	11.04	10.92	10.80	[VDC]
R _{down} (E96) ≈	768k	383k	249k	182k	143k	118k	97k6	84k5	73k2	63k4	[Ω]

REM15-xx15SW(P)

Trim up	1	2	3	4	5	6	7	8	9	10	[%]
V _{out_set} =	15.15	15.30	15.45	15.60	15.75	15.90	16.05	16.20	16.35	16.50	[VDC]
R _{up} (E96) ≈	162k	78k7	49k9	36k5	28k	22k6	18k7	15k8	13k3	11k5	[Ω]

Trim up	11	12	13	14	15	16	17	18	19	20	[%]
V _{out_set} =	16.65	16.80	16.95	17.10	17.25	17.40	17.55	17.70	17.85	18.00	[VDC]
R _{up} (E96) ≈	10k	8k8	7k6	6k8	6k	5k3	4k6	4k1	3k6	3k2	[Ω]

Trim down	1	2	3	4	5	6	7	8	9	10	[%]
V _{out_set} =	14.85	14.70	14.55	14.40	14.25	14.10	13.95	13.80	13.65	13.50	[VDC]
R _{down} (E96) ≈	825K	402k	261k	191k	150k	124k	105k	88k7	76k8	68k1	[Ω]

continued on next page

Specifications (measured @ Ta= 25°C, nominal input voltage, full load and after warm-up)

REM15-xx24SW(P)											
Trim up	1	2	3	4	5	6	7	8	9	10	[%]
V _{outset} =	24.24	24.48	24.72	24.96	25.20	25.44	25.68	25.92	26.16	26.40	[VDC]
R _{up} (E96) ≈	576k	280k	182k	133k	105k	84k5	69k8	95k3	52k3	45k3	[Ω]
Trim up	11	12	13	14	15	16	17	18	19	20	[%]
V _{outset} =	26.64	26.88	27.12	27.36	27.60	27.84	28.08	28.32	28.56	28.80	[VDC]
R _{up} (E96) ≈	40k2	35k7	31k6	28k7	26k1	23k7	21k5	19k6	17k9	16k2	[Ω]
Trim down	1	2	3	4	5	6	7	8	9	10	[%]
V _{outset} =	23.76	23.52	23.28	23.04	22.80	22.56	22.32	22.08	21.84	21.60	[VDC]
R _{down} (E96) ≈	4M99	2M43	1M62	1M18	931k	768k	649k	562k	487k	432k	[Ω]

REGULATIONS			
Parameter	Condition		Value
Output Accuracy			±1.0% max.
Line Regulation	low line to high line	Single Output	±0.2% max.
		Dual Output	±0.5% max.
Load Regulation	no load to full load	Single Output	0.2% max.
		Dual Output	1.0% max.
Cross Regulation	assymetrical load 25% / 100% full load	only Dual Output	±5.0% max.
Transient Response	recovery time	25% load step change	100µs typ. / 250µs max.

PROTECTIONS			
Parameter	Condition		Value
Short Circuit Protection (SCP) ⁽⁶⁾			continuous, auto-recovery
Over Load Protection (OLP)	% of lout rated		Hiccup mode, 150% typ. / 185% max.
Output Over Voltage Protection (OVP)	Zener diode clamp	5V _{out}	6.2VDC typ.
		12V _{out}	15VDC typ.
		15V _{out}	20VDC typ.
		24V _{out}	30VDC typ.
Over Temperature Protection (OTP)	at tc point (refer to " <i>Dimension Drawing (mm)</i> ")		+115°C max.
Isolation Voltage ⁽⁶⁾	I/P to O/P working voltage	tested for 1 minute continuous	5kVAC 250VAC
Isolation Resistance			2GΩ min.
Isolation Capacitance			20pF typ.
Leakage Current	240VAC, 60Hz		2µA typ. / 2.5µA max.
Insulation Grade			reinforced
Means of Protection			2MOPP
Medical Device Classification			built-in power supply
Clearance/Creepage			>8.0mm

Notes:

Note5: For repeat Hi-Pot testing, reduce the time and/or the test voltage

Note6: Refer to local safety regulations if input over-current protection is also required. Recommended fuse: slow blow type

Specifications (measured @ Ta= 25°C, nominal input voltage, full load and after warm-up)

ENVIRONMENTAL

Parameter	Condition		Value
Operating Temperature Range ⁽⁷⁾	with derating @ natural convection 0.1m/s		-40°C to +105°C
Max. Case Temperature			+110°C typ.
Operating Humidity			5% to 95% RH
Temperature Coefficient			0.02%/K
Thermal Impedance ⁽⁷⁾	horizontal direction	natural convection (0.1m/s)	9K/W
		0.5m/s	6.4K/W
Operating Altitude			5000m
Pollution Degree			PD2
Thermal Shock			according to MIL-STD-810F
Vibration			according to MIL-STD-810F
MTBF	according to MIL-HDBK-217F, full load	+25°C	2000 x 10 ³ hours

Notes:

Note7: Measured with test PCB: Eurocard 160x100mm 105µm copper, double layer

Derating Graph ⁽⁷⁾

(@ Chamber and nominal Vin)

REM15-24xxSW

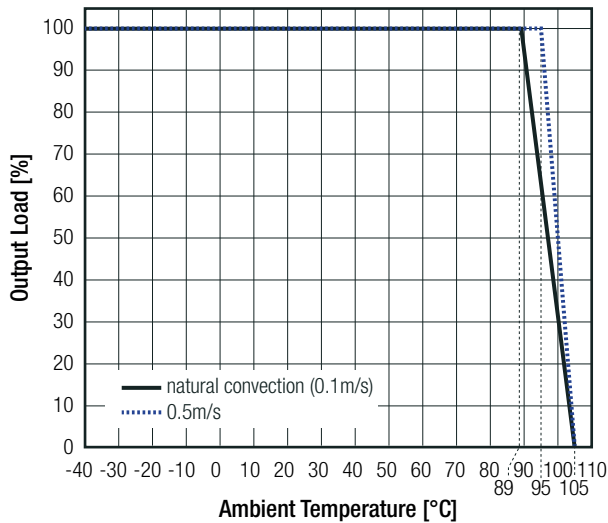

REM15-48xxSW

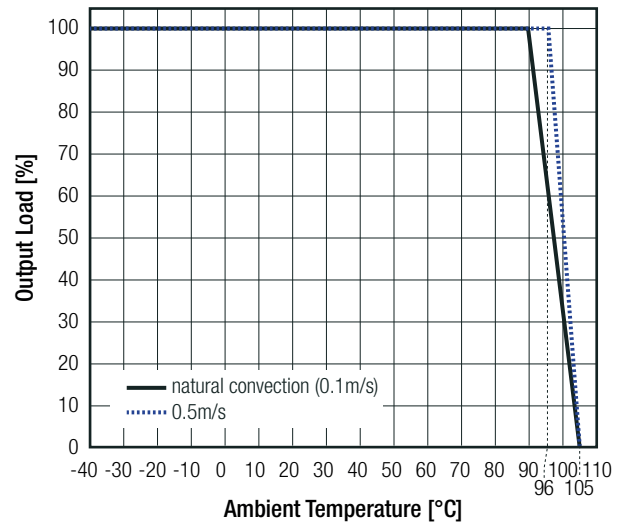

SAFETY AND CERTIFICATIONS

Certificate Type (Safety)	Report / File Number	Standard
Information Technology Equipment, General Requirements for Safety	E196683	UL60950-1, 2nd Edition, 2014 CAN/CSA-C22.2 No. 60950-1-07, 2nd Edition, 2014
Audio/video, information and communication technology equipment. Safety requirements		UL62368-1 CAN/CSA-C22.2 No. 62368-1
Medical Electric Equipment, General Requirements for Safety and Essential Performance	E314885	ANSI/AAMI ES60601-1 (2005/R2012 + A1:2012), 2012 CAN/CSA-C22.2 No. 60601-1:14, 3rd Edition, 2014-03
Medical Electric Equipment, General Requirements for Safety and Essential Performance (CB Scheme)	180505201	IEC60601-1:2005, 3rd Edition + AM1:2012
RoHS2+		RoHS 2011/65/EU + AM2015/863

continued on next page

Specifications (measured @ Ta= 25°C, nominal input voltage, full load and after warm-up)

EMC Compliance	Conditions	Standard / Criterion
Medical electrical equipment Part 1-2: Electromagnetic disturbances - Requirements and tests		EN60601-1-2:2015
Industrial, scientific and medical equipment - Radio frequency disturbance characteristics - Limits and methods of measurement	without external filter	EN55011, Class A
	with external filter	EN55011, Class B
		AS/NZS CISPR11:2011 Class A, B
ESD Electrostatic discharge immunity test	Air: ±2, 4, 8, 15kV and Contact: ±4, 6, 8kV	EN61000-4-2:2009, Criteria A IEC61000-4-2:2008, Criteria A
Radiated, radio-frequency, electromagnetic field immunity test	10V/m (80-2700MHz) and 9V/m, 27V/m, 28V/m (several frequencies)	EN61000-4-3:2006 + A2:2010, Criteria A IEC61000-4-3:2006 + A2:2010, Criteria A
Fast Transient and Burst Immunity ⁽⁸⁾	DC Power Port: ±0.5, 1, 2kV	IEC/EN61000-4-4:2012, Criteria A
Surge Immunity ⁽⁸⁾	DC Power Port: ±0.5, 1, 2kV	IEC/EN61000-4-5:2014, Criteria A
Immunity to conducted disturbances, induced by radio-frequency fields	DC Power Port 10V (0.15-80MHz)	EN61000-4-6:2014 + AC:2015, Criteria A
	DC Power Port 10V (ISM bands)	IEC61000-4-6:2013, Criteria A
Power Frequency Magnetic Field	50Hz, 100A/m (1 min) 1000A/m (1 sec)	EN61000-4-8:2010, Criteria A IEC61000-4-8:2009, Criteria A

Notes:

Note8: 24Vin models tested with 2pcs of Nippon chemi-con KY series (220µF/100V) MLCC and a TVS (SMDJ58A, 58V, 3000W peak pulse power) in parallel
48Vin models tested with 2pcs of Nippon chemi-con KY series (220µF/100V) MLCC and a TVS (SMDJ120A, 120V, 3000W peak pulse power) in parallel

EMC Filtering Suggestions according to EN55011

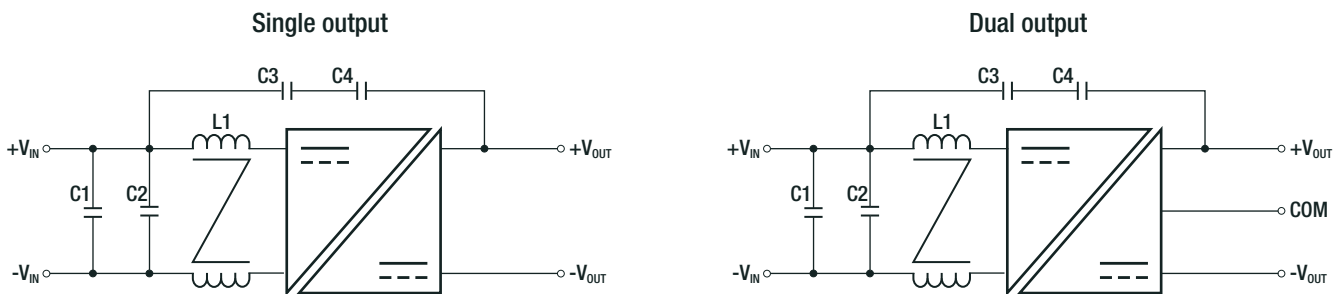

Component List Class B

nom. Vin	C1	C2	C3, C4	L1
24VDC	N/A	10µF/50V 1210 MLCC	100pF/3kV	145µH 5.2A CMC
48VDC	2.2µF/100V 1210 MLCC	2.2µF/100V 1210 MLCC	100pF/3kV	373µH 3A CMC

DIMENSION and PHYSICAL CHARACTERISTICS

Parameter	Type	Value
Material	case baseplate potting	non-conductive black plastic (UL94-V0) non-conductive black plastic (UL94-V0) silicone (UL94-V0)
Dimension (LxWxH)		40.6 x 25.4 x 10.2mm
Weight		24g

continued on next page

Specifications (measured @ Ta= 25°C, nominal input voltage, full load and after warm-up)

Dimension Drawing (mm)

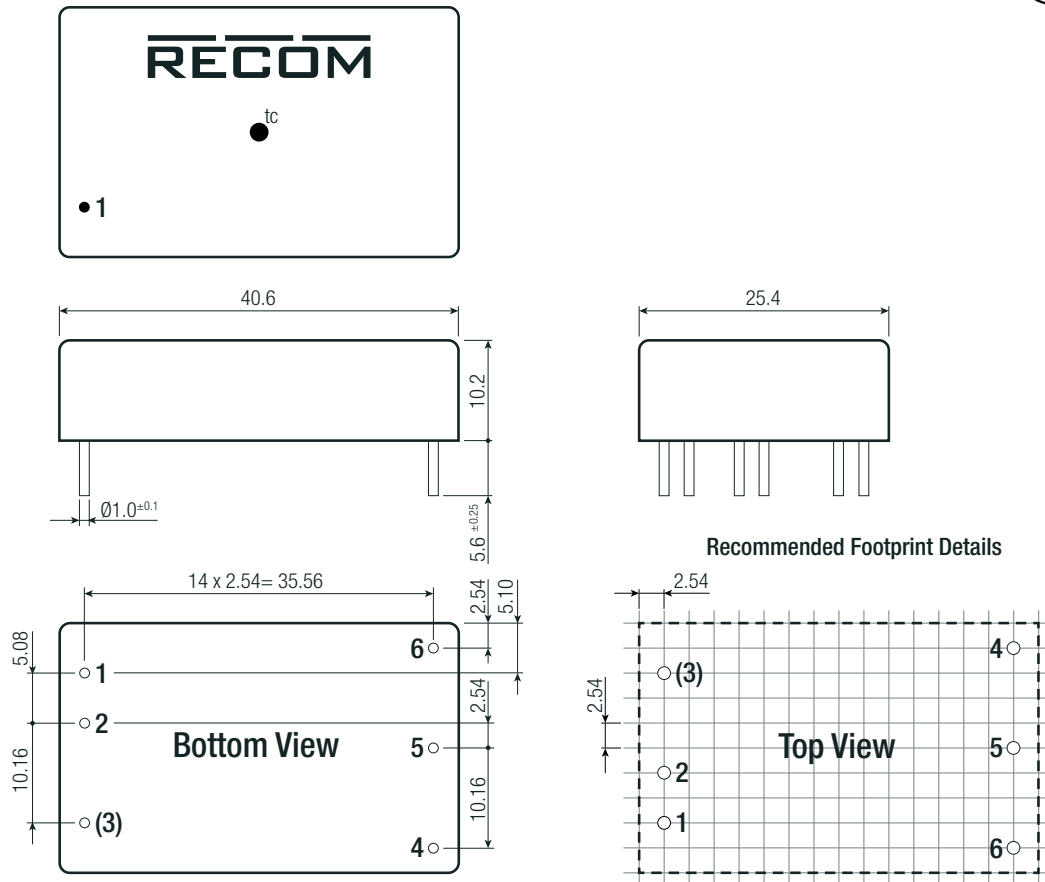
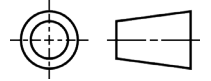

Pin Connections with suffix /P

Pin #	Single	Dual
1	+Vin	+Vin
2	-Vin	-Vin
3	CTRL	CTRL
4	Trim	-Vout
5	-Vout	Com
6	+Vout	+Vout

Tolerance: xx.x= ±0.5mm
xx.xx= ±0.25mm

Pin Connections without suffix /P

Pin #	Single	Dual
1	+Vin	+Vin
2	-Vin	-Vin
4	Trim	-Vout
5	-Vout	Com
6	+Vout	+Vout

Tolerance: xx.x= ±0.5mm
xx.xx= ±0.25mm

PACKAGING INFORMATION

Parameter	Type	Value
Packaging Dimension (LxWxH)	tube	290.0 x 43.5 x 19.7mm
Packaging Quantity		10 pcs
Storage Temperature Range		-55°C to +125°C
Storage Humidity	non-condensing	5% to 95% RH max.

The product information and specifications may be subject to changes even without prior written notice. The product has been designed for various applications; its suitability lies in the responsibility of each customer. The products are not authorized for use in safety-critical applications without RECOM's explicit written consent. A safety-critical application is an application where a failure may reasonably be expected to endanger or cause loss of life, inflict bodily harm or damage property. The applicant shall indemnify and hold harmless RECOM, its affiliated companies and its representatives against any damage claims in connection with the unauthorized use of RECOM products in such safety-critical applications.