

Series AMEL10-MAZ

10 Watt | AC-DC / DC-DC Converter



FEATURES:

- I/O Isolation 4000VAC
- Operating Temp: -40°C to +70°C
- Over load, Over Voltage, Short Circuit Protection
- Up to 80% efficiency
- Energy Star compliant
- Ultra small package

Models Single output



Model	Input Voltage (VAC/Hz)	Input Voltage (VDC)	Max Output wattage (W)	Output Voltage (V)	Output Current max (A)	Maximum capacitive load (µF)	Efficiency (%)
AMEL10-3.3SMAZ	90-264/47-440	130-370	9.9	3.3	3.00	2200	75
AMEL10-5SMAZ	90-264/47-440	130-370	10	5	2.00	1000	77
AMEL10-12SMAZ	90-264/47-440	130-370	10	12	0.84	680	79
AMEL10-15SMAZ	90-264/47-440	130-370	10	15	0.67	470	80
AMEL10-24SMAZ	90-264/47-440	130-370	10	24	0.42	470	80

Note: Optional mounting plate version can be ordered by adding “-ST” suffix to part number (ex. AMEL10-5SMAZ-ST)

Models Asymmetric Dual output

Model	Input Voltage (VAC/Hz)	Input Voltage (VDC)	Max Output wattage (W)	Output Voltage (V)	Rated Output Current (A)	Maximum capacitive load (µF)	Efficiency (%)
AMEL10-3.35DMAZ	90-264/47-440	130-370	7.9	3.3/5	0.9/1.0	680	74
AMEL10-3.312DMAZ	90-264/47-440	130-370	8	3.3/12	0.9/0.41	680	77
AMEL10-3.315DMAZ	90-264/47-440	130-370	8	3.3/15	0.9/0.33	680	76
AMEL10-3.324DMAZ	90-264/47-440	130-370	8	3.3/24	0.9/0.2	680	75
AMEL10-512DMAZ	90-264/47-440	130-370	8	5/12	0.6/0.41	470	75
AMEL10-515DMAZ	90-264/47-440	130-370	8	5/15	0.6/0.33	470	77
AMEL10-524DMAZ	90-264/47-440	130-370	8	5/24	0.6/0.2	470	72
AMEL10-1215DMAZ	90-264/47-440	130-370	8	12/15	0.25/0.33	330	76
AMEL10-1224DMAZ	90-264/47-440	130-370	9	12/24	0.25/0.25	330	78
AMEL10-1524DMAZ	90-264/47-440	130-370	9	15/24	0.2/0.25	330	79
AMEL10-3.3N5DMAZ	90-264/47-440	130-370	7.3	-3.3/5	-0.7/1.0	680	74
AMEL10-3.3N12DMAZ	90-264/47-440	130-370	8	-3.3/12	-0.9/0.41	680	75
AMEL10-3.3N15DMAZ	90-264/47-440	130-370	8	-3.3/15	-0.9/0.33	680	75
AMEL10-5N5DMAZ	90-264/47-440	130-370	8	-5/5	-0.6/1	680	74
AMEL10-5N12DMAZ	90-264/47-440	130-370	8	-5/12	-0.6/0.41	470	74
AMEL10-5N15DMAZ	90-264/47-440	130-370	8	-5/15	-0.6/0.33	470	74
AMEL10-12N12DMAZ	90-264/47-440	130-370	8	-12/12	-0.25/0.41	470	76
AMEL10-12N15DMAZ	90-264/47-440	130-370	8	-12/15	-0.25/0.33	330	75

Note: Optional mounting plate version can be ordered by adding “-ST” suffix to part number (ex. AMEL10-5SMAZ-ST)

*Output power must not exceed the listed values.

All specifications in this datasheet are measured at an ambient temperature of 25°C, humidity<75%, nominal input voltage and at rated output load unless otherwise specified.

Input Specifications

Parameters	Conditions	Typical	Maximum	Units
Current	115VAC	0.23		A
	230VAC	0.15		A
Inrush current <2ms (cold start)	115VAC		10	A
	230VAC		20	A
Leakage current			0.25	mA
External fuse	slow blow type	1		A

Input Specifications (continued)

Parameters	Conditions	Typical	Maximum	Units
Input dissipation	No Load	≤0.2		W
Start up time		50		ms

Output Specifications

Parameters	Conditions	Typical	Maximum	Units
Voltage accuracy		±2		%
Line regulation		±1		%
Load regulation (single output)	0-100% load	±2		%
Load regulation (dual output)	Unbalanced (0-100% load)	±3		%
Transient recovery time		500		µs
Transient response deviation	25% load step	±2		% of Vout
Ripple & Noise*	3.3 & 5V models	75		mV p-p
	12, 15 & 24V models	100		
Hold-up time (min)	115VAC	10		ms
	230VAC	25		

*Ripple and Noise are measured at 20MHz bandwidth by using a 0.1µF (M/C) & 4.7µF (E/C) parallel capacitor.

Isolation Specifications

Parameters	Conditions	Typical	Rated	Units
Tested I/O voltage	60 sec, 1.2mA		4000	VAC
Isolation resistance		>1000		MΩ
Isolation capacitor		2200		pF

General Specifications

Parameters	Conditions	Typical	Maximum	Units
Switching frequency	100% load	65		KHz
Protection class		Class II		
Over load protection	Auto recovery, Foldback	150		%
Over voltage protection		Zener Diode Clamp		
Short circuit protection		Continuous		
Short circuit restart		Auto recovery		
Operating temperature	See derating table	-40 to +70		°C
Maximum case temperature			100	°C
Storage temperature		-45 to +95		°C
Temperature coefficient		±0.02		% / °C
Cooling		Free air convection		
Humidity	Non condensing	20 ~ 95		% RH
Case material		Plastic resin + Fiberglass (flammability to UL 94V-0)		
Weight		70		g
Dimensions (L x W x H)		2.22 x 1.21 x 0.99 inches	56.48 x 30.86 x 25.10mm	
MTBF		> 400 000 hrs (MIL-HDBK -217F, t=+25°C)/Full Load > 100,000 hrs (MIL-HDBK -217F, t=at highest operating temperature)/Full Load		

Environment Approval

Test	Parameters	Conditions
Shock	Wave form	Half sine wave
	Acceleration amplitude	5gn
	Bump duration	30 ms
	Converter operation	before and after test, body mounted (on chassis)
	Number of bumps	18 (3 in each direction for every axis)
Vibration	Test mode	Sweep sine
	Displacement	1mm
	Acceleration	3g
	Converter operation	10-100Hz, speed 0.05Hz/s

Safety Specifications

Parameters		
Agency approvals	cULus, CE, CB	
Standards	Medical Electrical Equipment	IEC\EN\UL 60601-1, 2 x MOOP, CSA-C22.2 No. 601.1-M90
	Information technology Equipment	EN 60950-1:2006+A11:2009
	EMI - Conducted and radiated emission	EN55022, class B
	Harmonic Current Emissions	IEC/EN 61000-3-2, Class A
	Voltage fluctuations and flicker	IEC/EN 61000-3-3, (EN60555-3)
	Electrostatic Discharge Immunity	IEC 61000-4-2 Level 3
	RF, Electromagnetic Field Immunity	IEC 61000-4-3 Level 2
	Electrical Fast Transient/Burst Immunity	IEC 61000-4-4 Level 2
	Surge Immunity	IEC 61000-4-5 Level 3
	RF, Conducted Disturbance Immunity	IEC 61000-4-6 Level 2
	Power frequency Magnetic Field Immunity	IEC 61000-4-8
	Voltage dips, Short Interruptions Immunity	IEC 61000-4-11
	Information Technology Equipment	UL 60950-1:2007
Information Technology Equipment	CAN/CSA-C22.2 No.60950-1-07	

Additional Surge Protective Circuitry

The AMEL10-MAZ series design level surge protection is certified to IEC 61000-4-5 surge Line to Line of 1KV. However greater protection can be enhanced by adding protective devices to ingress circuitry. For example, by adding an MOV (Metal Oxide Varistor) device example TVR10471KSY to the N / L input lines 2KV surge protection or greater, can be achieved.

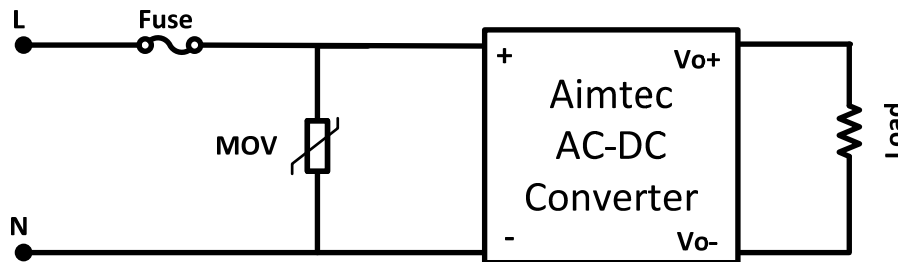

MOV PN	Vrms V	Vdc V	Wmax (2ms) J	Pmax W
TVR10471KSY	300	385	70	0.4

Pin Out Specifications

Pin	Single	Dual positive	Dual negative/positive
1	AC Input (N)	AC Input (N)	AC Input (N)
2	AC Input (L)	AC Input (L)	AC Input (L)
3	+V Output	+V1 Output	+V1 Output
4	-V Output	Common	Common
5	No pin	+V2 Output	-V2 Output

Dimensions

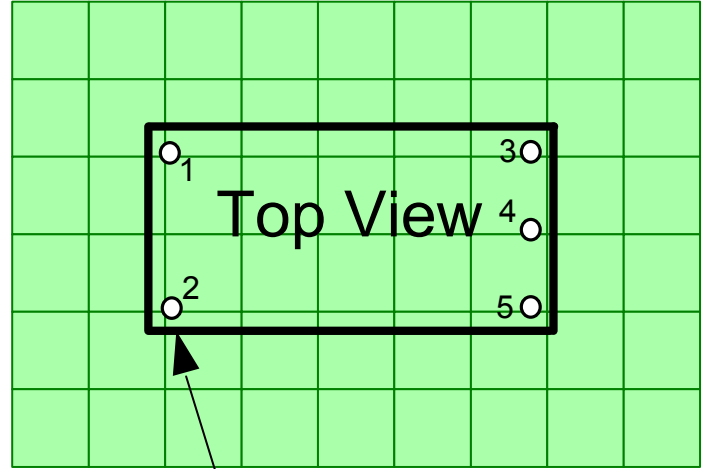
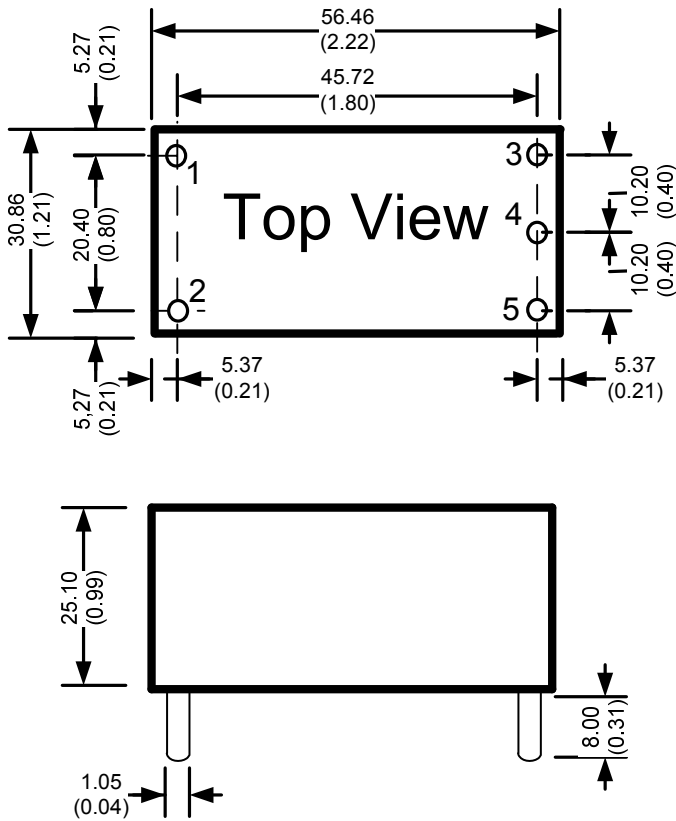

Dimensions mm (inch)
 Case Tolerance ± 0.50 (± 0.02)
 Pin Diameter 1.0 ± 0.05 (0.04 ± 0.002)
 Pin Pitch Tolerance ± 0.35 (± 0.014)

Derating

Free Air Convection

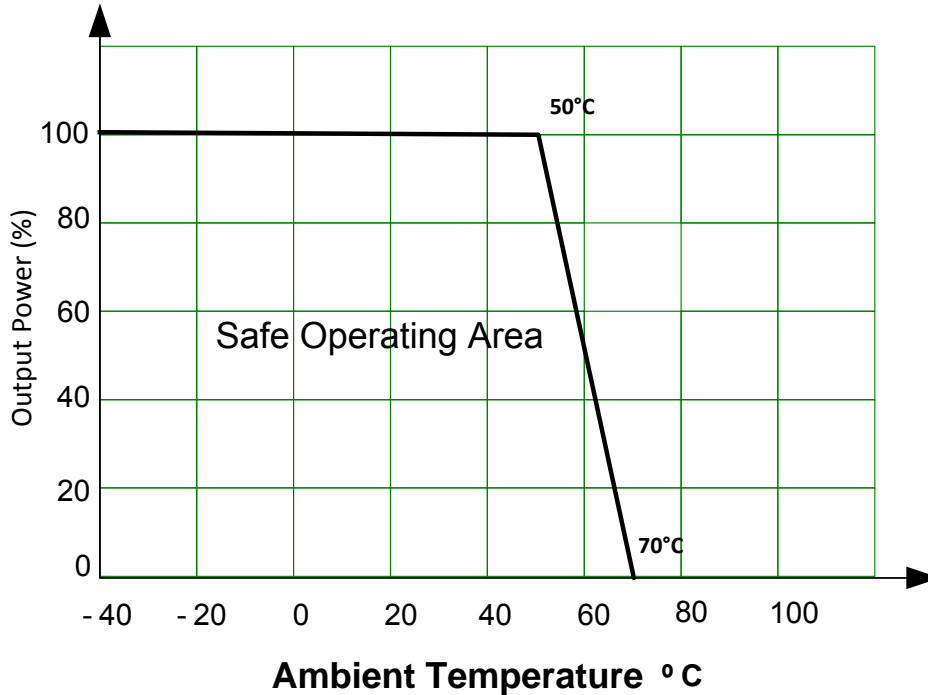

Derating (Dual Output Models)

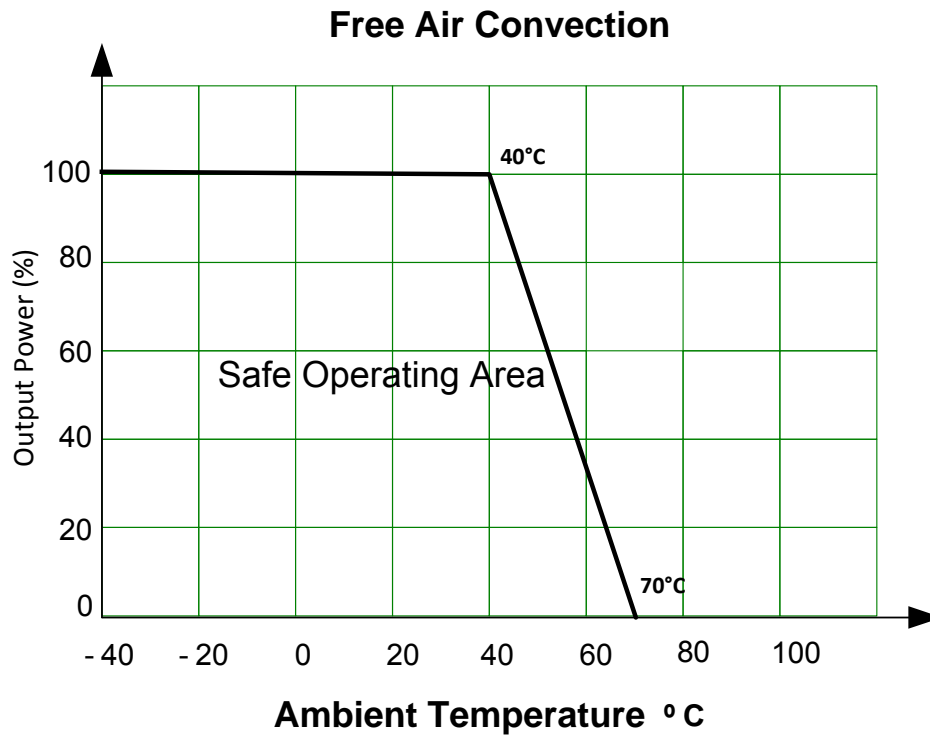

Dimensions of Optional ST Mounting Plate Version

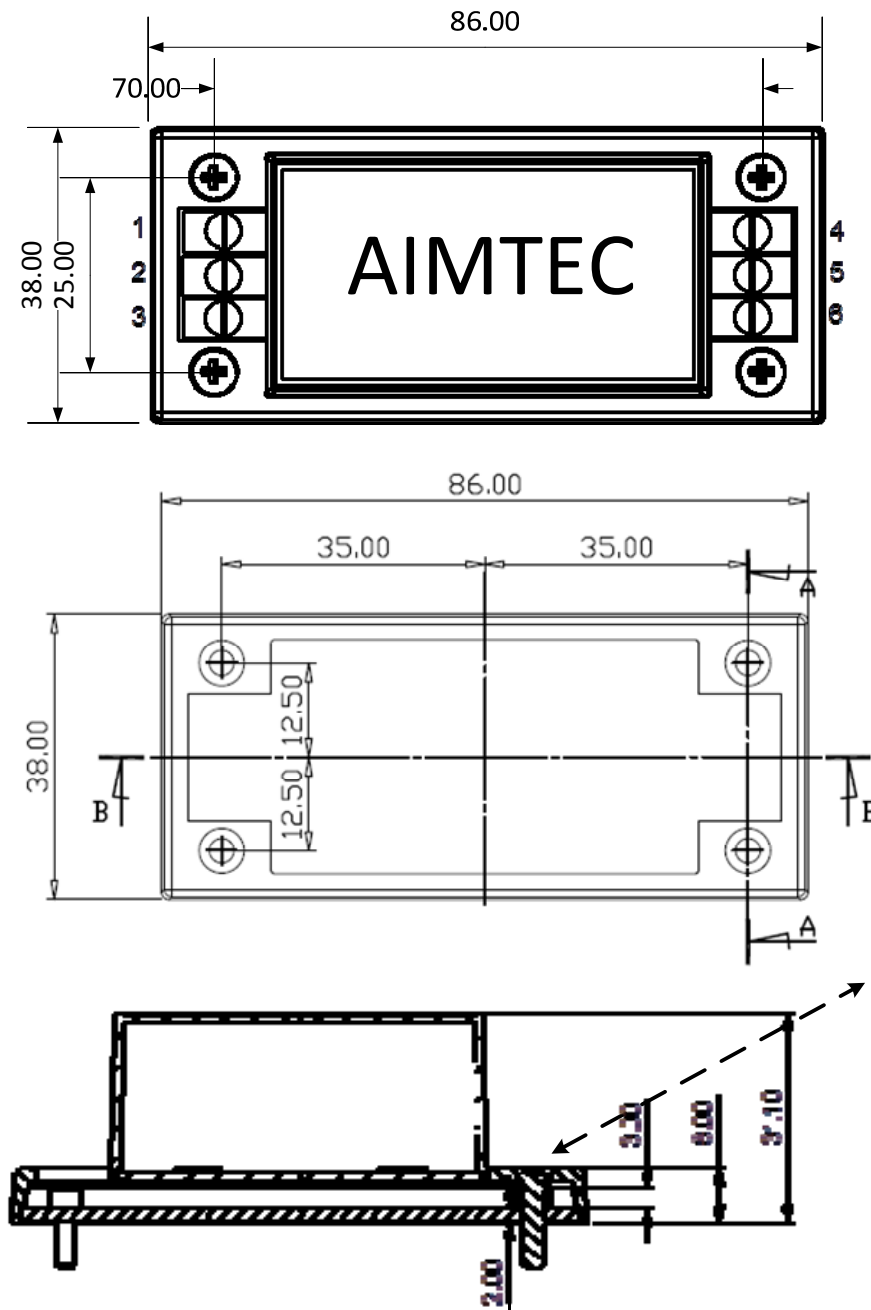

Pin Out Specification ST Version

Pin	Single	Dual positive	Dual negative / positive
1	AC Input (L)	AC Input (L)	AC Input (L)
2	No pin	No pin	No pin
3	AC Input (N)	AC Input (N)	AC Input (N)
4	+V Output	+V1 Output	+V1 Output
5	Common	Common	Common
6	No pin	+V2 Output	-V2 Output

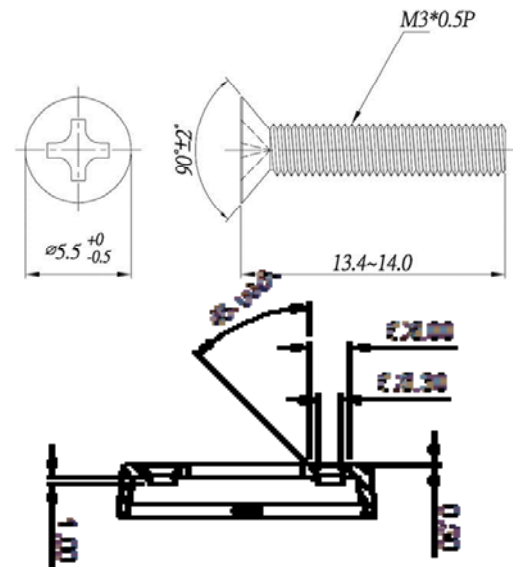

NOTE: 1. Datasheets are updated as needed and as such, specifications are subject to change without notice. Once printed or downloaded, datasheets are no longer controlled by Aimtec; refer to www.aimtec.com for the most current product specifications. 2. Product labels shown, including safety agency certifications on labels, may vary based on the date manufactured. 3. Mechanical drawings and specifications are for reference only. 4. All specifications are measured at an ambient temperature of 25°C, humidity<75%, nominal input voltage and at rated output load unless otherwise specified. 5. Aimtec may not have conducted destructive testing or chemical analysis on all internal components and chemicals at the time of publishing this document. CAS numbers and other limited information are considered proprietary and may not be available for release. 6. This product is not designed for use in critical life support systems, equipment used in hazardous environments, nuclear control systems or other such applications which necessitate specific safety and regulatory standards other the ones listed in this datasheet. 7. Warranty is in accordance with Aimtec's standard Terms of Sale available at www.aimtec.com.