



## ■ Features

- Slim and Low profile (41mm)
- Fanless and conduction-cooled design
- Withstand 300VAC surge input for 5 seconds
- Built-in active PFC function
- -30~+70°C working temperature
- Protections: Short circuit / Overload / Over voltage / Over temperature
- DC OK relay contact
- Operating altitude up to 5000 meter (Note.6)
- LED indicator for power on
- 3 years warranty

## ■ Certificates

- Safety: UL/EN62368-1
- EMC: EN 55032 / 55024

## ■ Applications

- Industrial automation machinery
- Industrial control system
- Mechanical and electrical equipment
- Electronic instruments, equipment or apparatus
- Household appliances

## ■ Description

UHP-750 series is a 750W single-output slim type power supply with 41mm of low profile design. Adopting the full range 90~264VAC input, the entire series provides an output voltage line of 12V, 24V, 36V and 48V. In addition to the high efficiency up to 95%, that the whole series operates from -30°C ~ 70°C under air convection without fan. UHP-750 has the complete protection functions and 5G anti-vibration capability; It is complied with the international safety regulations such as TUV EN62368-1 and UL62368-1. and the design refers to EN61558-1 and EN60335-1. UHP-750 series serves as a high performance power supply solution for various industrial applications.

## ■ Model Encoding

UHP - 750 - 12

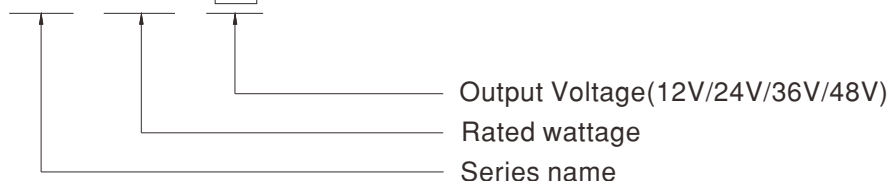



**SPECIFICATION**

MODEL		UHP-750-12	UHP-750-24	UHP-750-36	UHP-750-48
OUTPUT	DC VOLTAGE	12V	24V	36V	48V
	RATED CURRENT	60A	31.3A	20.9A	15.7A
	RATED POWER(convection)	720W	751.2W	752.4W	753.6W
	RIPPLE & NOISE (max.) Note.2	150mVp-p	200mVp-p	250mVp-p	250mVp-p
	VOLTAGE ADJ. RANGE	12~14.4V	24~28.8V	36~43.2V	48~57.6V
	VOLTAGE TOLERANCE Note.3	±1.0%	±1.0%	±1.0%	±1.0%
	LINE REGULATION	±0.5%	±0.5%	±0.5%	±0.5%
	LOAD REGULATION	±0.5%	±0.5%	±0.5%	±0.5%
	SETUP, RISE TIME	1000ms, 50ms/230VAC 1000ms,50ms/115VAC at full load			
HOLD UP TIME (Typ.)	12ms/230VAC	12ms/115VAC			
INPUT	VOLTAGE RANGE Note.4	90 ~ 264VAC	127 ~ 370VDC		
	FREQUENCY RANGE	47 ~ 63Hz			
	POWER FACTOR (Typ.)	PF ≥ 0.95/230VAC PF ≥ 0.99/115VAC at full load			
	EFFICIENCY (Typ.)	93.5%	95%	95%	95%
	AC CURRENT (Typ.)	7.5A/115VAC 3.8A/230VAC			
	INRUSH CURRENT (Typ.)	Cold start 20A/115VAC 40A/230VAC			
LEAKAGE CURRENT	<0.75mA / 240VAC				
PROTECTION	OVERLOAD	105~125% rated output power Protection type: Hiccup mode, recovers automatically after fault condition is removed			
	OVER VOLTAGE	14.5 ~ 16V	29 ~ 33V	43.5 ~ 49V	59 ~ 66V
	OVER TEMPERATURE	Protection type: Shut down O/P voltage, recovers automatically after temperature goes down			
FUNCTION	DC-OK SIGNAL	Contact rating(max.): 30Vdc/1A resistive load			
ENVIRONMENT	WORKING TEMP.	-30 ~ +70°C (Refer to "Derating Curve")			
	WORKING HUMIDITY	20 ~ 90% RH non-condensing			
	STORAGE TEMP., HUMIDITY	-40 ~ +85°C, 10 ~ 95% RH non-condensing			
	TEMP. COEFFICIENT	±0.03%/°C (0 ~ 50°C)			
	VIBRATION	10 ~ 500Hz, 5G 10min./1cycle, 60min. each along X, Y, Z axes			
SAFETY & EMC (Note.5)	SAFETY STANDARDS	UL62368-1,TUV EN62368-1, EAC TP TC 004 approved; Design refer to EN61558-1, EN60335-1			
	WITHSTAND VOLTAGE	I/P-O/P: 3KVAC I/P-FG: 2KVAC O/P-FG: 0.5KVAC			
	ISOLATION RESISTANCE	I/P-O/P, I/P-FG, O/P-FG: 100M Ohms/500VDC/25°C / 70%RH			
	EMC EMISSION	Parameter	Standard		Test Level / Note
		Conducted	EN55032 (CISPR32)		Class B
		Radiated	EN55032 (CISPR32)		Class B
		Harmonic Current	EN61000-3-2		Class A
	Voltage Flicker	EN61000-3-3		-----	
	EMC IMMUNITY	EN55024 , EN61000-6-2			
		Parameter	Standard		Test Level / Note
ESD		EN61000-4-2		Level 3, 8KV air ; Level 2, 4KV contact	
Radiated		EN61000-4-3		Level 3	
EFT / Burst		EN61000-4-4		Level 3	
Surge		EN61000-6-2		2KV/Line-Line 4KV/Line-Earth	
Conducted		EN61000-4-6		Level 3	
Magnetic Field	EN61000-4-8		Level 4		
Voltage Dips and Interruptions	EN61000-4-11		>95% dip 0.5 periods, 30% dip 25 periods, >95% interruptions 250 periods		
OTHERS	MTBF	279.97K hrs min. Telcordia SR-332 (Bellcore); 104.86K hrs min. MIL-HDBK-217F (25°C)			
	DIMENSION	237*100*41mm (L*W*H)			
	PACKING	1.4kg; 10pcs/15kg/0.8CUFT			
NOTE	<p>1. All parameters NOT specially mentioned are measured at 230VAC input, rated load and 25°C of ambient temperature.</p> <p>2. Ripple &amp; noise are measured at 20MHz of bandwidth by using a 12" twisted pair-wire terminated with a 0.1uf &amp; 47uf parallel capacitor.</p> <p>3. Tolerance :includes set up tolerance, line regulation and load regulation.</p> <p>4. Derating may be needed under low input voltages. Please check the derating curve for more details.</p> <p>5. The power supply is considered a component which will be installed into a final equipment. All the EMC tests are been executed by mounting the unit on a 360mm*360mm metal plate with 1mm of thickness. The final equipment must be re-confirmed that it still meets EMC directives. For guidance on how to perform these EMC tests, please refer to "EMI testing of component power supplies." (as available on <a href="http://www.meanwell.com">http://www.meanwell.com</a>)</p> <p>6. The ambient temperature derating of 3.5°C/1000m with fanless models and of 5°C/1000m with fan models for operating altitude higher than 2000m(6500ft).</p>				

**BLOCK DIAGRAM**

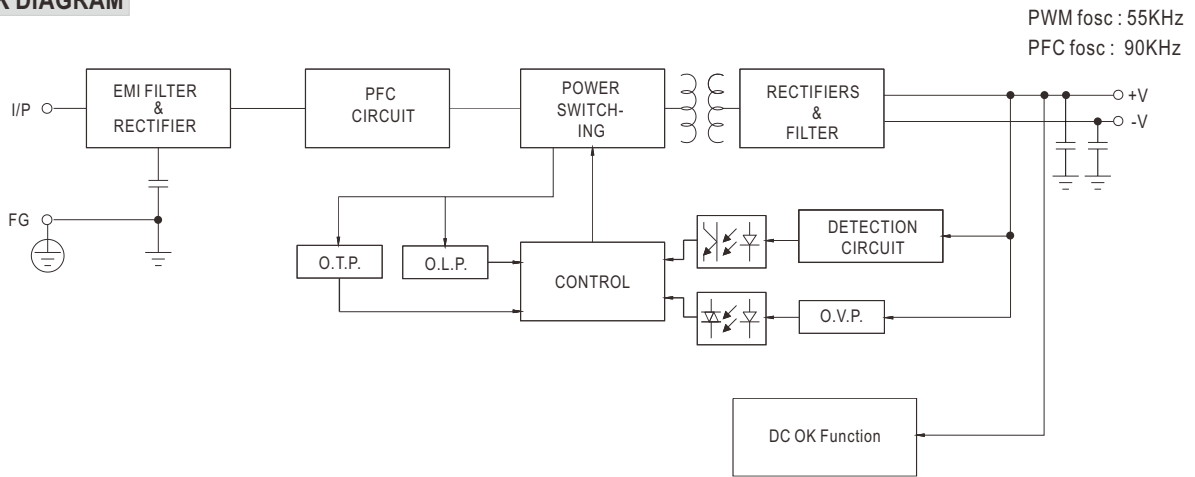

**STATIC CHARACTERISTIC**

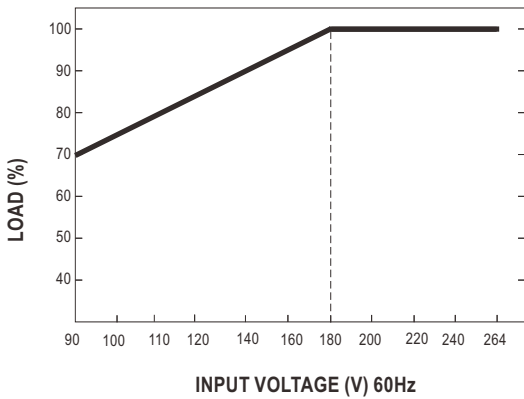

**EFFICIENCY VS LOAD (48V MODEL)**

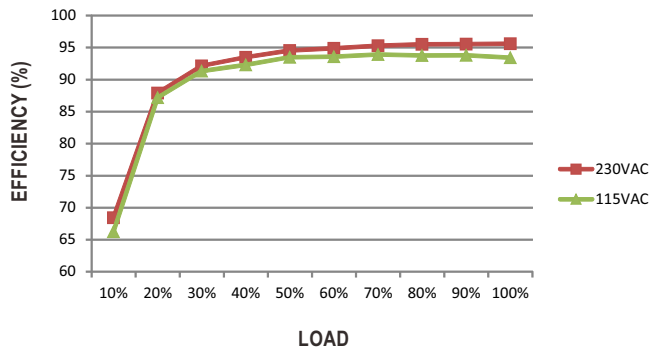

**DERATING CURVE**

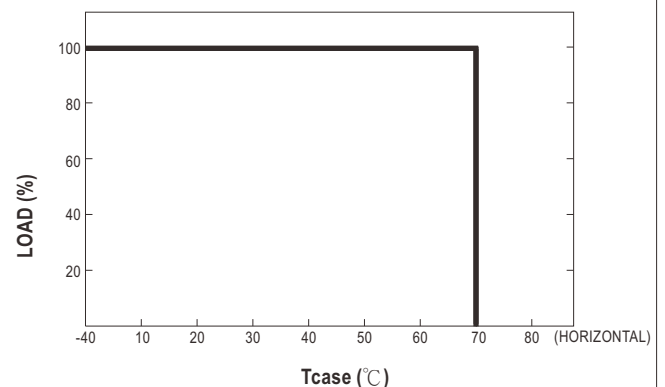
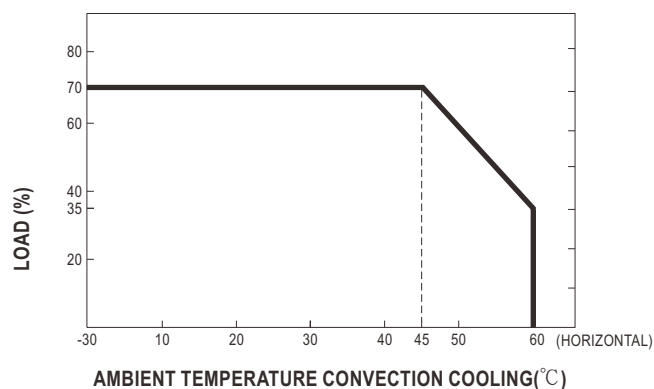
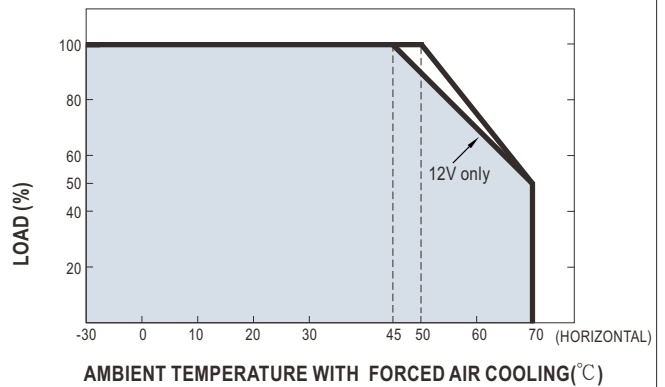
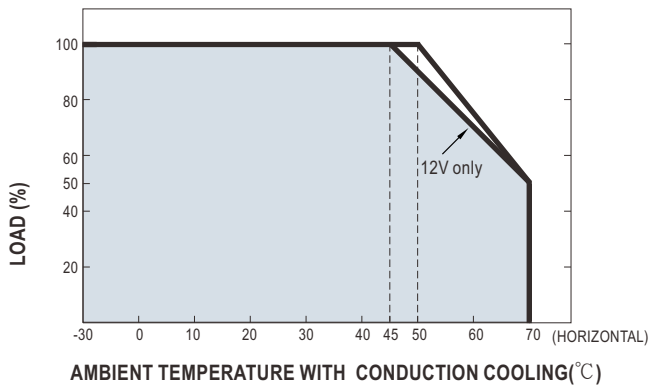

■ DC OK RELAY CONTACT

Contact Close	PSU turns on/DC ok
Contact Open	PSU turns off/DC fail
Contact Rating(max.)	30Vdc/1A resistive load

■ MECHANICAL SPECIFICATION

Case No.270B Unit:mm

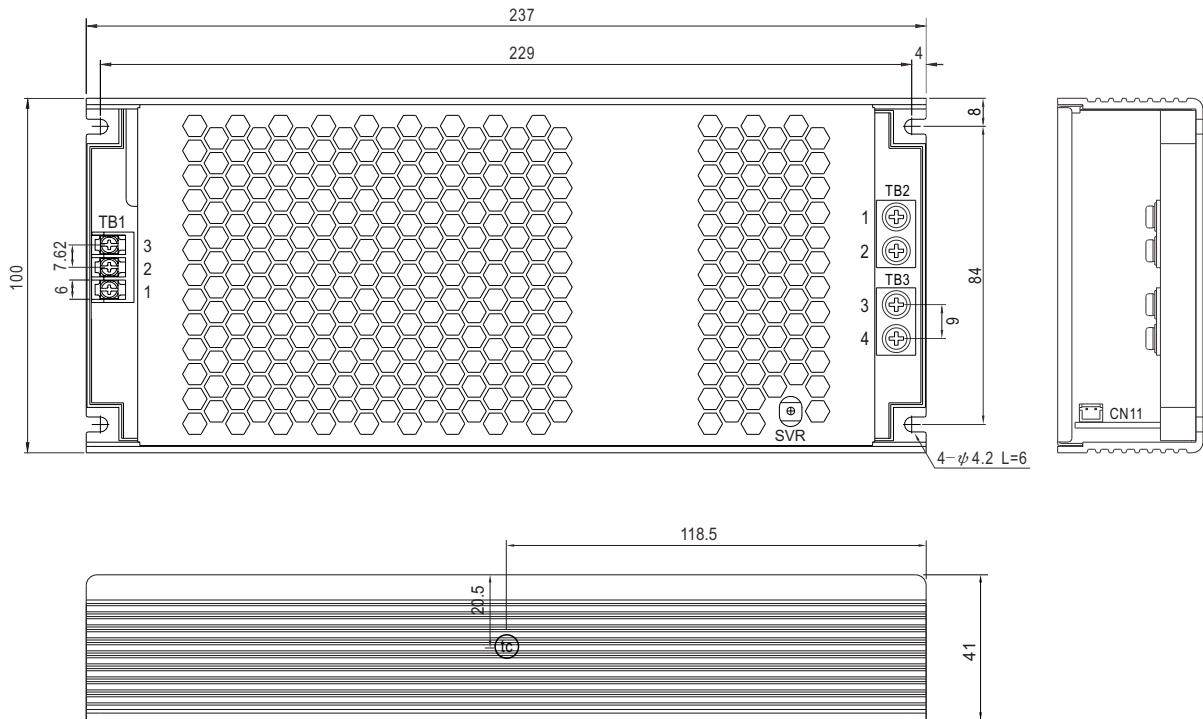

AC Input Terminal(TB1) pin NO. Assignment

Pin No.	Assignment	Terminal	Max mounting torque
1	AC/L	DECA T21-EM10-03	5Kgf-cm
2	AC/N		
3	⊕		

DC Output Terminal(TB2, TB3) pin NO. Assignment

Pin No.	Assignment	Terminal	Max mounting torque
1,2	+V	(MW)	8Kgf-cm
3,4	-V	NEL-400-02P	

DC OK Connector(CN11):JST S2B-PH-KL or equivalent

Pin No.	Assignment	Mating Housing	Terminal
1	DC COM1	JST PHR-2 or equivalent	JST SPH-002T-P0.5S or equivalent
2	DC COM2		

**Operate with additional aluminum plate and fan**

In order to meet the "Derating Curve" and the "Static Characteristics", UHP-750 series can be installed onto an aluminum plate (or the cabinet of the same size) on the bottom or apply forced air cooled solution. The size of the suggested aluminum plate and configuration of fan are shown as below. And for optimizing thermal performance, the aluminum plate must have an even and smooth surface (or coated with thermal grease), and UHP-750 series must be firmly mounted at the center of the aluminum plate.

unit:mm

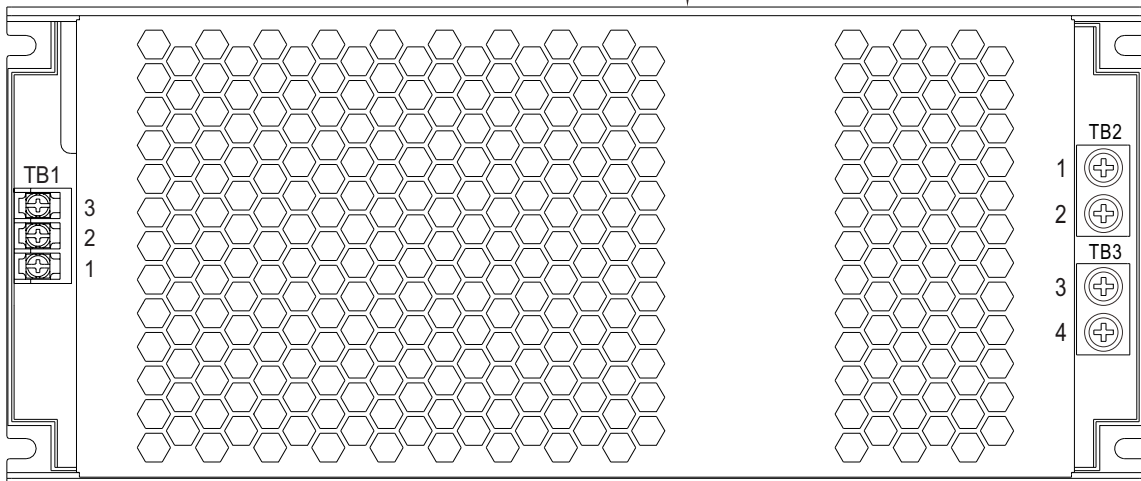
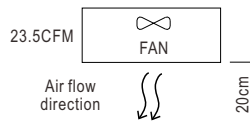
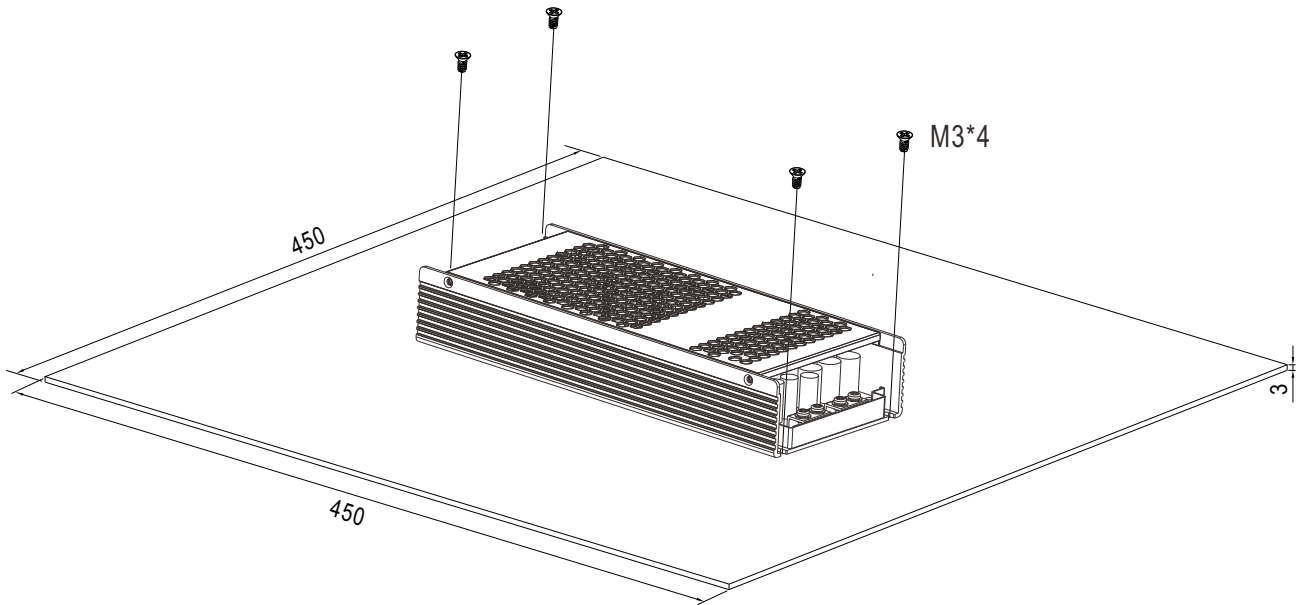

■ **INSTALLATION MANUAL**

Please refer to : <http://www.meanwell.com/manual.html>