

**PRODUCT  
SPECIFICATION**

DOC NO.: MLP674361-01

REV. : A0

SHEET : 1 of 17

# Specification Approval Sheet

**Customer:** Mikroe

**Customer Model name:** \_\_\_\_\_

**Customer P/N:** /

**Model name:** MLP674361

**P/N:** \_\_\_\_\_

**Cell P/N:** \_\_\_\_\_

**Issuing Date:** JuL.26.2011

**Customer Approved**

**Date:**

Prepared By	QA Checked	RD Checked	Approved
Thomas Liu	谢长癸	刘曰岚	张继昌



# PRODUCT SPECIFICATION

DOC NO.: MLP674361-01  
REV. : A0  
SHEET : 3 of 18

## CONTENTS

<b>Pack Specification Sheet.....</b>	<b>4</b>
1. Scope.....	4
2. Model: MLP674361.....	4
3. Specification.....	4
4. Safety Performance.....	5
5. Temperature Applicability.....	5
6. ESD.....	5
7. Warranty period.....	5
8. Product Liabilit .....	5
9. Storage .....	5
Fig.1 Outline Drawing.....	6
Fig.2 Silk-screen Drawing.....	7
Fig.3 Package.....	8
10. PCM Specification.....	9
<b>Cell Specification Sheet.....</b>	<b>11</b>
1. Scope.....	11
2. Description and Model.....	11
3. Specifications.....	11
4. Shape/Dimension and Appearance.....	11
5. Standard Test Condition.....	12
6. Test Procedure and its Standard.....	12
7. Safety Criteria for Acceptance.....	13
8. Self Discharge.....	13
9. Charge State of Battery Before Shipment.....	13
10. RoHs compliance is for all parts.....	13
11. Handling Precautions.....	14
Fig. 5 Monomer Dimension Drawing.....	17

# PRODUCT SPECIFICATION

DOC NO.: MLP674361-01REV. : A0SHEET : 4 of 17

## Pack Specification Sheet

### 1. Scope

This document describes the Product Specification of the Lithium-ion Polymer (LIP) rechargeable battery MLP674361

### 2. Model: MLP674361

### 3. Specification

No.	Items	Specifications
1	Appearance	The surface is clear and no scratch, no mechanical abrasion, match well with the main machine
2	Charge voltage	4.2V
3	Nominal voltage	3.7V
4	Minimum capacity (0.2C)	2000mAh(at 0.2C rate discharge process after standard charge)
5	Standard Charge method	0.5C CC(constant current) charge to 4.2V, then CV(constant voltage 4.2V) charge till charge current decline to $\leq 0.02C$
6	Charging time	3.0 hours (Ref.)
7	Standard Discharge	Constant current 0.5C 3.0V Cut-off
8	Max. charge current	1.0 C (charging time:2.0 hours,Ref.)
9	Max. discharge current	2.0C (for non-continuous discharge mode) 1.0C(for continuous discharge mode)
10	Operating temperature	Charging: 0°C ~ 45°C Discharging: -20°C ~ 60°C
11	Storage (At 50% SOC and specified temp, recoverable capacity in % vs time. )	-20°C~25°C (12 months, $\geq 85\%$ )
		-20°C ~35°C (3 months, $\geq 85\%$ )
		-20°C ~45°C (1 month, $\geq 90\%$ )
12	Cycle Life	$\geq 300$ cycles, more than80% at 0.5C rate discharge
13	Pack dimension	Refer to Fig.1 Outline drawing (page 6).
14	Pack Initial Internal Impedance	$R \leq 260m\Omega$ (50% SOC, Measure the AC impedance t 1kHz)
15	Pack weight	Approx.78.5g
16	Delivery voltage	3.7~3.95V
17	Environmental Requirement	RoHs Compliance

# PRODUCT SPECIFICATION

DOC NO.: MLP674361-01REV. : A0SHEET : 5 of 17

## 4. Safety Performance

No.	Items	Test Method and Condition	Criteria
1	Over-Charge Protection	At $20 \pm 5^{\circ}\text{C}$ conditions , after fast-charging, use an external 5V power to charge the battery and last for 8 hours, then check the appearance of battery.	The appearance is normal, no explosion, no fire,no smoking, no leakage.
2	Over-Discharge Protection	At $20 \pm 5^{\circ}\text{C}$ conditions, discharge battery to 2.5V with 0.2C constant current, then discharge with $30 \Omega$ loading for 24 hours. Check the appearance of battery.	The appearance is normal, no Explosion, no fire,no smoking, no leakage.
3	Short-Circuit Protection	After fast-charging, use a cable of $0.1 \Omega$ resistance to short the battery for 1 hour. Then check the appearance of battery. Cut circuit of resistance, test the battery's voltage after charging with 1C constant current for 5 seconds.	The appearance is normal, no explosion, no fire,no smoking, and no leakage.

## 5. Temperature Applicability

### 5.1. Discharge Performance at High Temperature

At  $55 \pm 2^{\circ}\text{C}$  conditions, keep the battery for 2hrs, discharge the battery to 2.5V with 0.2C constant current, After keep the battery 2hrs at  $20 \pm 5^{\circ}\text{C}$ , then check the appearance of battery. The discharge capacity is above 80% of original capacity. The appearance is no distortion, no explosion, no leakage.

### 5.2 Discharge Performance at Low Temperature

At  $-10 \pm 2^{\circ}\text{C}$  conditions, keep the battery for 2hrs, discharge the battery to 2.5V with 0.2C constant current, After keep the battery 2hrs at  $20 \pm 5^{\circ}\text{C}$ , then check the appearance of battery.

The discharge capacity is above 60% of original capacity. The appearance is no distortion, no explosion, no leakage.

## 6. ESD

At direct discharge against the pins with  $\pm 4\text{kv}$  and over the housing with  $\pm 8\text{kv}$ .

No damages are allowed.

## 7. Warranty period

Warranty period of this product is 12 months from delivery date.

## 8. Product Liability

You are kindly requested to use the battery, which is delivered from M in strict accordance with the specification, and remarks include at the end of the document. Due to improper usage of the battery, an accident or a fire may occur due to the battery generating heat, catching fire or rupture, smoke. M will not guarantee against any accidents occurring due outside those written in this specification

## 9. Storage

When battery long-term storage, or assembly in the host, suggeste customer should take every 6months carry on one time charge and discharge and recharge it to half-charge state (3.80-3.95V/cell)(the method: 0.2CmA charge and discharge ).

# PRODUCT SPECIFICATION

DOC NO.: MLP674361-01

REV. : A0

SHEET : 6 of 17

Fig.1 OUTLINE DRAWING

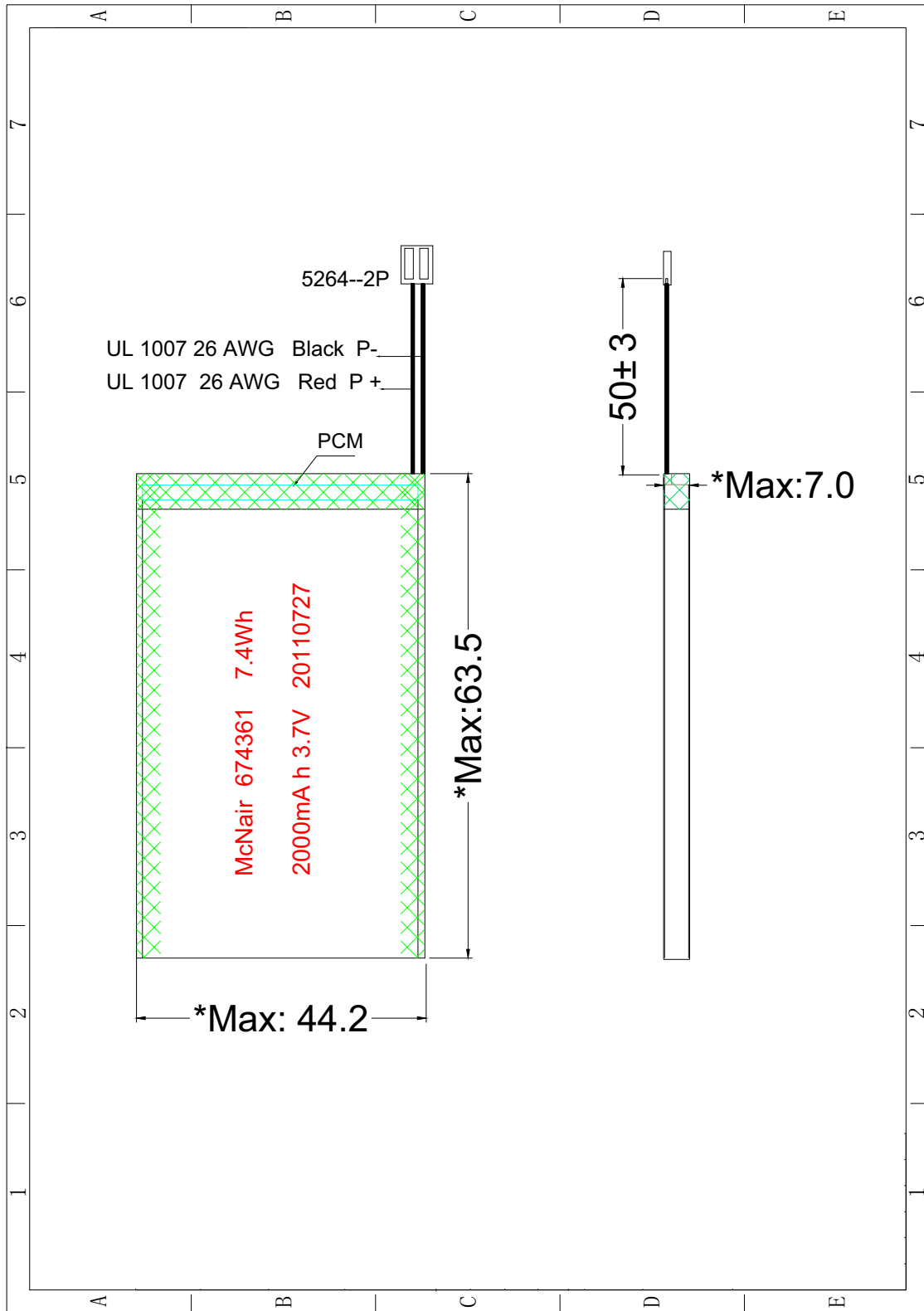

# PRODUCT SPECIFICATION

DOC NO.: MLP674361-01

REV. : A0

SHEET : 8 of 17

### Fig.3 Package (FYI)

The battery are delivered in trays with X sets. See attached figure  
Y trays are packed in a package(X×Y sets in one packaging. then put into carton box.  
Total gross weight(include batteries and package) :10Kg MAX

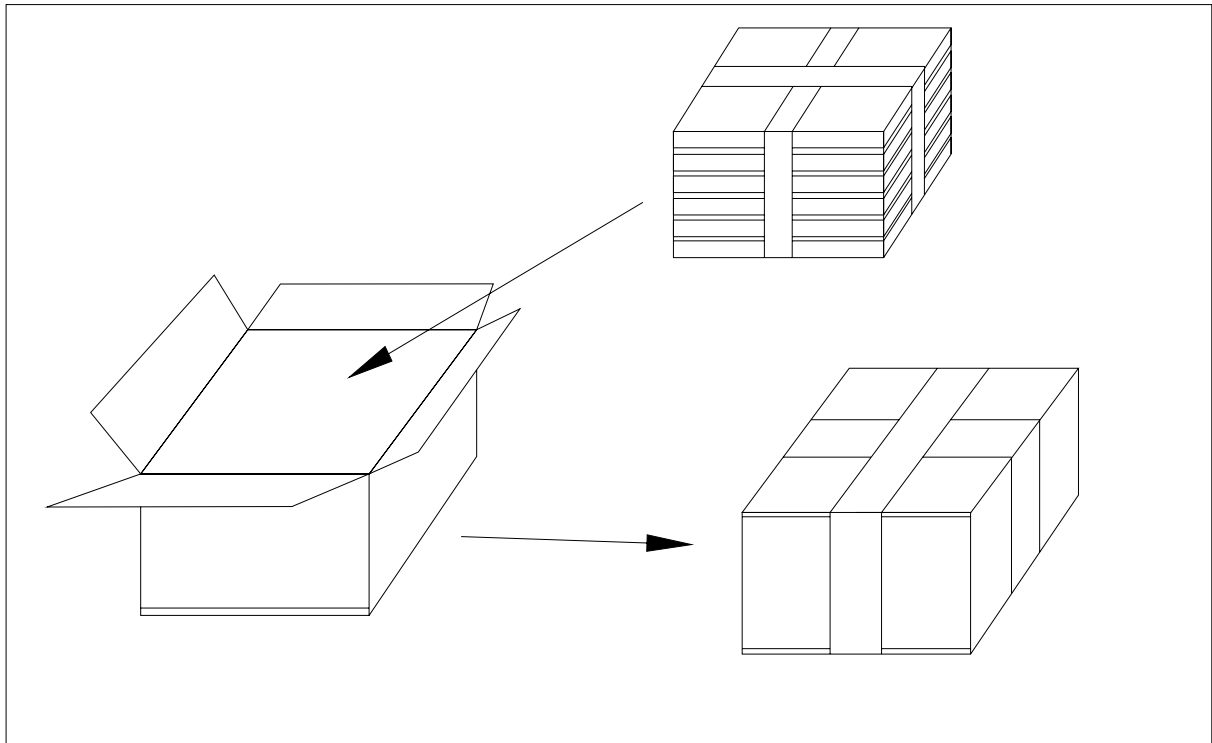
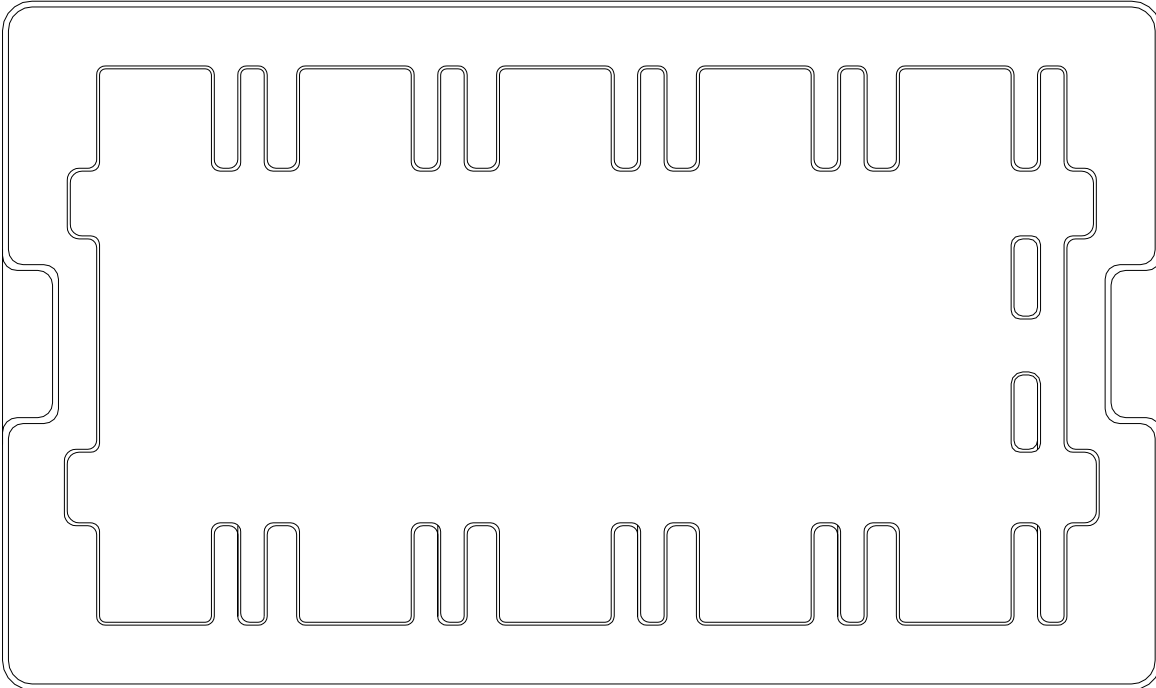

# PRODUCT SPECIFICATION

DOCNO.: MLP674361-01

REV. : A0

SHEET : 9 of 17

## 10. PCM Specification

### 10.1 Scope

The specification is applied to the protection of one cell Lithium-Ion Polymer battery from overcharge, over discharge, over current and short-circuit.

8.2 Model: MK-322950-V1.0

### 8.3 Diagram:

#### 8.3.1. Arrange line diagram:

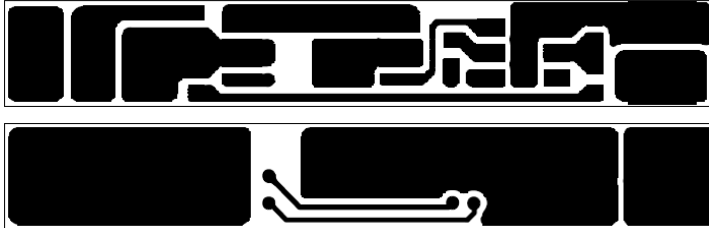

#### 10.3.2. Top arrange organ diagram:

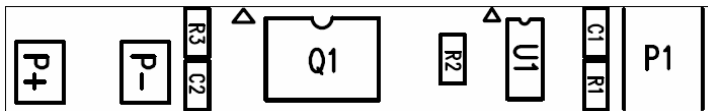

### 10.4 PCB Elucidation:

1. Plank material: FR4 whole glass
2. Copper skin thickness: 1 ounce
3. Electroplate the craft: Plate gold (unleaded)
4. Resistance oil color: Green
5. The silk prints oil color: White.



# PRODUCT SPECIFICATION

DOCNO.: MLP674361-01

REV. : A0

SHEET : 10 of 17

## 10.5 Electricity parameter (Environment temperature 25°C):

Item	Name	Term	Min	Typical	Max	Units
Voltage	Over charge detection voltage		4.250	4.300	4.350	V
	Over discharge detection voltage		2.30	2.40	2.50	V
Current	Static estate current		/	/	10	μA
	Over current protection		2	3.5	6	A
	Short circuit protection		OK			
Resistance			/	/	100	mΩ

## 10.6 Elements diagram:

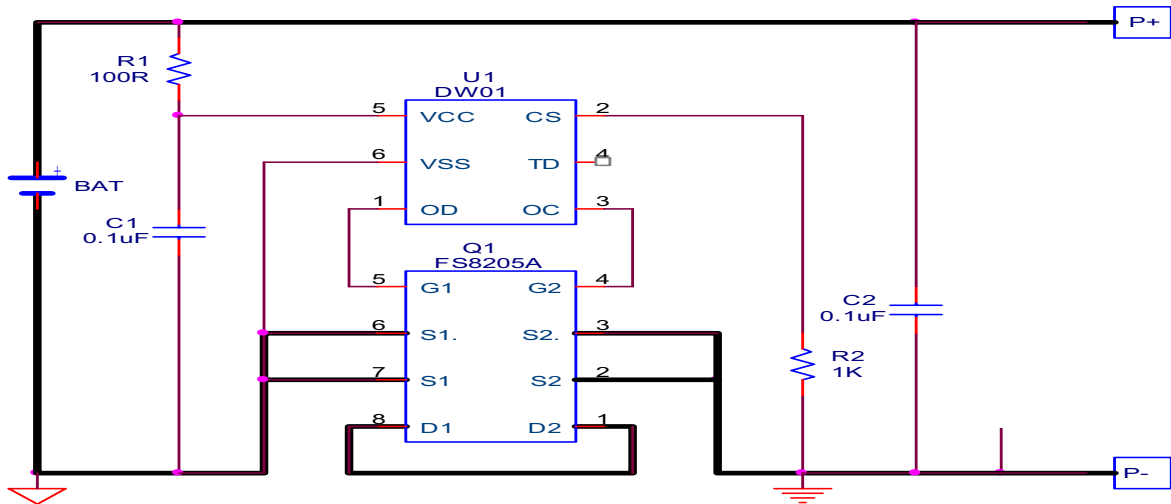

## 10.7 BOM (FYI)

No.	Name	Specification	Number
1	C1, C2	0.1UF ±20% 0402 25V	2
2	R1	100 Ω ±5% 0402	1
3	R2	1K Ω ±5% 0402	1
4	U1	DW01/SOT23-6	1
5	Q1	FS8205A/TSSOP-8	1
	PCB	MK-322950-V1.0	1

# PRODUCT SPECIFICATION

DOC NO.: MLP674361-01REV. : A0SHEET : 11 of 17

## CELL Specification Sheet

### 1. Scope

The purpose of this product specification is to provide technical information for the rechargeable Lithium-ion polymer cell MLP674361, manufactured and supplied by M

### 2. Description and Model

2.1	Description	Rechargeable Lithium-ion Polymer Battery
2.2	Model	MLP674361

### 3. Specifications

3.1	Typical Capacity	2050mAh (at 0.5C rate discharge process after standard charge)
3.2	Minimum Capacity	2000mAh (at 0.5C rate discharge process after standard charge)
3.3	Charging Voltage	4.2V
3.4	Normal Voltage	3.7V
3.5	Standard Charge	Constant current 0.5C Constant voltage 4.2V 0.05C cut-off
3.6	Charge time	3.0hours (Standard charge)
3.7	Standard Discharge	Constant current 0.5C 3.0V Cut-off
3.8	Max. Charge Current	1.0C
3.9	Max. Discharge Current	1.5C (for non-continuous discharge mode) 1.0C (for continuous discharge mode)
3.10	Cycle Life	≥300 cycles, more than 80% at 0.5C rate discharge
3.11	Temperature range of operation	
	Standard Charge	0°C ~ 45°C
	Discharge	-20°C ~ 60°C
3.12	Weight of Battery	Approx37.5g
3.13	Initial Internal Impedance	≤60mΩ (50% SOC)
3.14	Storage	-20°C~25°C (12 months, ≧85% ) (At 50% SOC and specified temp, recoverable capacities in % vs time. ) -20°C ~35°C (3 months, ≧85% ) -20°C ~45°C (1 month, ≧90% )

### 4. Shape/Dimension and Appearance

- 4.1 Shape/Dimension  
See attached drawing for (Fig. 4).
- 4.2 Appearance

Free from any abnormal strain, deformation, nor damage or any noticeable scratch, flaw, rust, discoloration or electrolyte leakage.

# PRODUCT SPECIFICATION

DOC NO.: MLP674361-01  
 REV. : A0  
 SHEET : 12 of 17

## 5. Standard Test Condition

### 5.1 Environmental Conditions

Unless otherwise specified, all tests shall be conducted within one month of delivery at the temperature  $23\pm 5^{\circ}\text{C}$  and the relative humidity  $65\pm 20\%$ .

### 5.2 Test Equipments

#### 5.2.1 Ammeter and voltmeter

The ammeter and voltmeter shall have an accuracy of  $\pm 0.1\text{mA}$  and  $\pm 0.1\text{mV}$ , respectively.

#### 5.2.2 Slide caliper

The slide caliper shall meet with JIS B7507 standard (slide caliper) and have a scale of 0.01mm.

#### 5.2.3 Impedance meter

The impedance meter shall be operated at 1 kHz.

## 6. Test Procedure and its Standard

	Item	Measuring Procedure	Standard
6.1	Appearance	Visual	No Defects and Leakage
6.2	Dimension	Caliper for dimension	As item 4
6.3	Weight	Balance	As item 3.12
6.4	Open Circuit Voltage	Voltmeter	3.7~3.95V
6.5	Initial Internal Impedance	Measure the AC impedance at 1kHz	$\leq 60\text{m}\Omega$ (50% SOC)
6.6	Discharge Capacity	Within 1 hr after standard charge, discharge at 0.2C until final discharge voltage of 3.0V	$\geq 2000\text{mAh}$ (min.)
6.7	Maximum Discharge Current	Until final discharge end voltage of 3.0V	1.0C
6.8	Charge/Discharge Cycle Life (Rest for 10 min. between each cycle.)	1) Charge: CC- 0.5C, CV-4.2V, Cut-off current: 0.05C 2) Discharge: 0.5C to 3.0 V	Discharge capacity should be $\geq 80\%$ of 1st cycle capacity @ 300th cycle.
6.9	Leakage Proof	The cell fully charged shall be stored at $60\pm 3^{\circ}\text{C}$ and relative humidity $95\pm 5\%$ for 7 days.	No leakage.
6.10	Temp. Characteristic (Charge: CC/CV, CC-0.5C, CV-4.2V Cut-off 0.05C.)	Discharge: 0.5C to 3.0V at $-10\pm 3^{\circ}\text{C}$ and $60\pm 3^{\circ}\text{C}$ , respectively. Hold for 1 hr after standard charging at $23\pm 3^{\circ}\text{C}$ .	Discharge capacity should be $\geq 60\%$ for $-10\pm 3^{\circ}\text{C}$ and $\geq 95\%$ for $60\pm 3^{\circ}\text{C}$ .

# PRODUCT SPECIFICATION

DOC NO.: MLP674361-01REV. : A0SHEET : 13 of 17

## 7. UL 1642 Safety Criteria for Acceptance

Item	State	Test method	Specification
External Short-circuit Test	Fully Charged	Cell terminals are short-circuited for 6 hours or longer with a resistance of 50mΩ or less. Tests are to be conducted at room temperature and 55°C.	NO EXPLOSION or FIRE.
Forced-Discharge Test	Fully Charged	Cell is discharged at a current of 1C rate for 2.5 hours. (If current stops by safety or passive circuit on the battery, test is finished.)	NO EXPLOSION or FIRE.
Heating Test	Fully Charged	The temperature of the oven is to be raised at a rate of 5±2°C/min. to a temperature of 130±2°C, and remains for 10 minutes at this temperature.	NO EXPLOSION or FIRE.
Crush Test	Fully Charged	Crush between two flat plates. Applied force is about 13kN.	NO EXPLOSION or FIRE.
Impact Test	Fully Charged	Impact between bar (15.8mm diameter) and 9 Kg falling material (at a height of 60 cm). Bar is laid across the center of the test sample.	NO EXPLOSION or FIRE.
Drop Test	Fully Charged	Drop a fully charged cell onto a concrete floor from the height of 1.8 meters for 6 times per axis.	NO EXPLOSION or FIRE.
Vibration Test	Fully Charged	Vibrate the cell in tri-axial directions each for 90~100 min. in conditions of frequency 10 ~ 55 Hz with amplitude 0.8 mm.	NO EXPLOSION DEFORMATION or FIRE
Short Circuit Test	Fully Charged	The battery shall be subjected to a short-circuit condition with a wire of resistance less than 50mΩ for 1 hour.	NO EXPLOSION or FIRE.
Abnormal Charge Test	Fully Discharged	Charging the battery by 3C and 4.4 V for 7 hrs.	NO EXPLOSION or FIRE.

## 8. Self Discharge

The residual capacity should be  $\geq 90\%$  of the initial capacity. The capacity after 30 days storage, measured under the same conditions as 23±3°C and relative humidity 65±20% environmental test conditions.

Data is collected by fully charging the battery, measuring the initial capacity (discharging), recharging the battery, storing the battery, and then measuring the residual capacity after storing.

## 9. Charge State of Battery Before Shipment

The battery is charged to approximately 50% of minimum capacity. Voltage is 3.7V~3.95V. This measuring test should be performed within one month after shipment from our factory.

## 10. RoHS compliance is for all parts.

# PRODUCT SPECIFICATION

DOC NO.: MLP674361-01

REV. : A0

SHEET : 14 of 17

## 11. Handling Precautions

M battery pack shall have enough protection for M cell from the specification of electrical, mechanical and environmental characteristics. For use of this battery, must follow as specified below. Other than UL1642 safety requirement conditions listed may cause major burst, fire, some smokes and it would cause severe performance failure and unsafe for use. Please be sure to follow instructions carefully.

### **DANGERS:**

(1) Don't disassemble or modify the battery.

The battery has safety function and protection circuit to avoid the danger. M cell is packaged by Aluminum laminated plastic film which is easy to be damaged by sharp edge such as pin, needle, edge of devices like nickel tabs, etc. If they have serious damage, electrolyte leakage, short-circuit between positive and negative tabs, etc. It would cause the generation, smoke, rupture, or flaming with mishandling.

(2) Don't incinerate or heat the battery

Don't use or leave battery nearby fire, stove or heated place (more than 130°C). These occur the melting of insulator, damage of safety function, or ignition on electrolyte. In case that separator made of polymer is melted by high temperature, the internal short-circuit occurs in individual cells and then it would cause the generating, smoke, rupture or flaming.

(3) Don't use any damage battery

Do not use the battery that are dented or bent on their edge part. M batteries are possible to be damaged by strong mechanical shock and it would cause wire break, short-circuit inside the cell, leakage of electrolyte, etc.

(4) Don't use battery nearby the high temperature place or under the blazing sun.

M batteries have possibility to be degraded its performance such as capacity, thickness increase, impedance, etc. The battery will be charged at the abnormal chemical reaction occurs in the high temperature place. The thickness change may lead to stressing on battery case/ device, wiring or cell which may have possibility to lead to damage performance.

(5) Don't use the unspecified charger.

If the battery is charged with unspecified condition (under high temperature over the regulated value, excessive high voltage or current over regulated value, or remodeled charger with PCM failed or disassemble), there are causes that it will be overcharged or the abnormal chemical reaction will occur in cells. It causes the gas generating, smoke, rupture or flaming.

# PRODUCT SPECIFICATION

DOC NO.: MLP674361-01

REV. : A0

SHEET : 15 of 17

- (6) Don't drive a nail into a battery, strike it by hammer, or tread it.  
As the battery might be broken or deformed and then it will be short-circuited, it would cause the generating, smoke, rupture or flaming.
- (7) Don't give battery impact or fling it  
If the protection circuit assembled in the battery is broken, the battery will be charged at abnormal voltage or current and abnormal chemical reaction will occur. It may cause the generating, smoke, rupture or flaming.
- (8) Don't make the direct ultrasonic wave power to the battery or soldering near the battery  
It may cause serious damage to the batteries. Soldering near the battery may cause damage of the components, such as separator and insulator, are melted by heat, it would cause the gas generating, smoke, rupture or flaming.
- (9) Don't reverse polarity (and terminals)  
If the protection circuit assembled in the battery is broken. On charging, the battery is reversed-charged and abnormal chemical reaction occurs. And also, there may be case that unexpected large current flows on discharging. There causes the generating, smoke, rupture or flaming.
- (10) Don't reverse-charge or reverse-connect  
The battery has polarity. In case the battery is not connected with charger or equipment smoothly do not force them to connect and do check polarity of battery. If the battery is connected to opposite polarity with charger. It will be reverse-charged and abnormal chemical reaction will occur. If the protection circuit assembled in the battery is broken, it would cause the generating, swelling, smoke, rupture or flaming.
- (11) Don't connect battery to the plug socket or car-cigarette-plug  
Added high voltage to the battery, if the protection circuit assembled in the battery is broken, the excessive current will flow in it and then it may cause the generating, swelling, smoke, rupture or flaming.
- (12) Don't use battery for another equipment  
If the battery is used for unspecified equipment, it will deteriorate its performance and cycle-life.
- (13) Don't touch a leaked battery directly  
In case the leaked electrolyte gets into eyes, wash them with fresh water as soon as possible without rubbing eyes. And then, see a doctor immediately.  
If leave damaged eyes undone, it will cause eye-trouble.

## **WARNINGS:**

- (1) Keep the battery away from babies  
Keep the little battery out of the reach of babies in order to avoid troubles by swallowing.  
In case of swallowing the battery, see a doctor immediately.

# PRODUCT SPECIFICATION

DOC NO.: MLP674361-01

REV. : A0

SHEET : 16 of 17

**(2)** Don't get into a microwave or a high pressure container

Because of sudden heat or damage of sealing condition of battery, it may cause the generating, smoke, rupture or flaming.

**(3)** Don't use a leaked battery nearby fire

If the liquid leaks from the battery (or the battery gives out bad smell), let the battery leave from flammable objects immediately. Unless do that, the electrolyte leaked from battery may catch fire and it would cause the smoke, flaming or rupture of it.

**(4)** Don't use an abnormal battery, such as leakage, swelling, deformation, etc.

In case the battery has bad smell, it generates, its color change or it is warped in using (includes charging and storage), let it take out from equipment or charger and do not use it. If an abnormal battery is used, it may generate bad performance or damage the device or pack.

## **CAUTIONS:**

**(1)** Don't use or leave the battery under the blazing sun (or in heated car by sunshine)

The battery may smoke, heat or flame. And also, it might cause the deterioration of battery's characteristics or cycle life.

**(2)** Static Electricity

The battery has the protection circuit to avoid the danger. Do not use nearby the place where generates static electricity (more than 100V) which gives damage to the protection circuit. If the protection circuit were broken under abnormal handling, the battery would generate, smoke, rupture or flame.

**(3)** Manual

Please read the manual before using the battery and let it keep after reading. And also, please read it necessary.

**(4)** Charging Method

Please read the manual of specific charger about charging method.

**(5)** First time use

When the battery has rust, bad smell or something abnormal at first-time-using, do not use the equipment and go to the shop which it was bought.

## **DISPOSAL METHOD:**

The used battery is immersed in NaCl 2~3 % water solution for 1 week. Then, it is disassembled and this battery should be handled according to all national laws and regulations.

# PRODUCT SPECIFICATION

DOC NO.: MLP674361-01  
 REV. : A0  
 SHEET : 17 of 17

**Fig.4 Monomer Dimension Drawing**  
(not in scale)

Items	Description	Dimension and Spec
T	Thickness	6.7 mm max (before shipment)
		7.24 mm max (after swelling)
W	Width	43.8mm max
L	Length	61mm max
A	Sealant Length	0.2~2.5mm
B	Tab width	4.0±0.1mm
L1	Distance between 2 tabs	6.5±2.5mm(ref.)
L2		33.3±2.5 mm

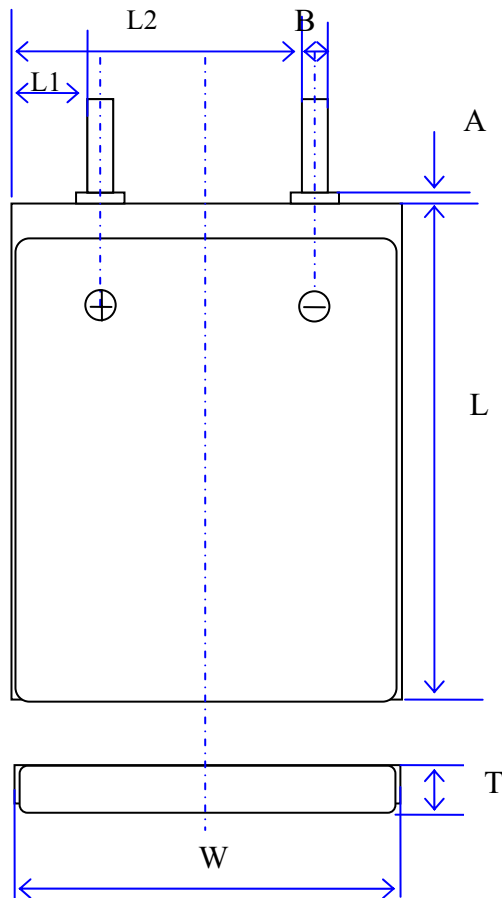



# Mouser Electronics

Authorized Distributor

Click to View Pricing, Inventory, Delivery & Lifecycle Information:

[MikroElektronika:](#)

[MIKROE-1120](#)