



1294



1295

SPECIFICATIONS

Body: Molded from high impact, Glass Filled Nylon
Terminals: Brass, Tin Plate
Contacts: Steel, Nickel Plate

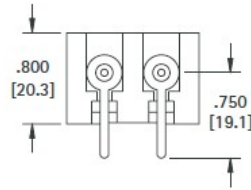
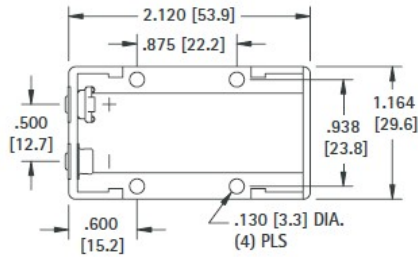

CAT. NO. 1294
PC Terminals

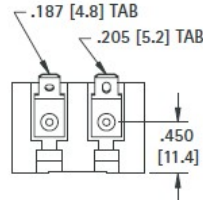

CAT. NO. 1295
Quick-Fit Terminals

Mounting Detail

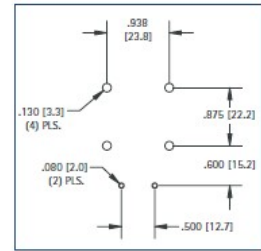

Holds any size, any shape, standard 9 Volt battery. Eliminates need to specify an exact battery brand, size or shape. Ideal for power source or memory back-up use in PLC, telecommunications, data processing, security systems, clocks, radios, toys and appliances.

- Male-female snap-in terminals assure positive contact and proper polarity
- Durable, rugged construction
- Excellent spring retention – holds battery in place
- Withstands severe shock and vibration
- Operating temperature range: -40°F to +266°F (-40°C to +130°C)
- Impervious to most industrial solvents

9 VOLT SNAP-IN BATTERY HOLDERS

For use with standard 9 Volt battery. Battery snaps in place to insure positive contact. Ideal where severe shock and vibration are encountered. Available with standard solder lugs or printed circuit lugs.



1290-79



1291-79

SPECIFICATIONS

Frame: Aluminum
Solder Lugs: Brass, Tin Plate
PC Lugs: Brass, Tin Plate
Contacts & Clips: Steel, Nickel Plate
Insulation: Resin Impregnated
Polarizing Washer: Polyethylene

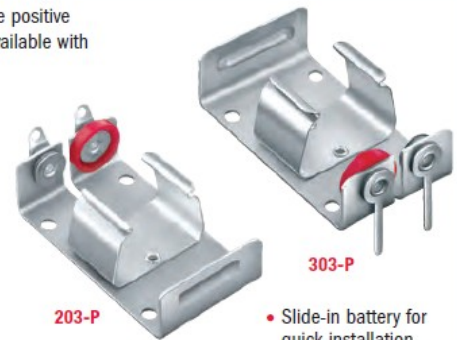

303-P

203-P

- Slide-in battery for quick installation and replacement
- Polarity clearly marked

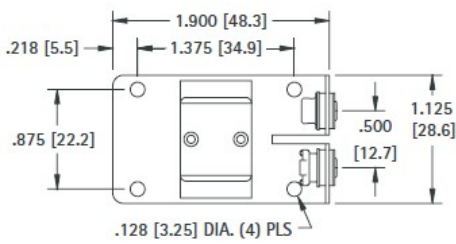

Mounting Detail

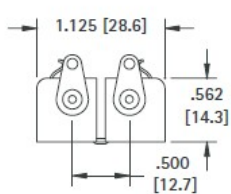
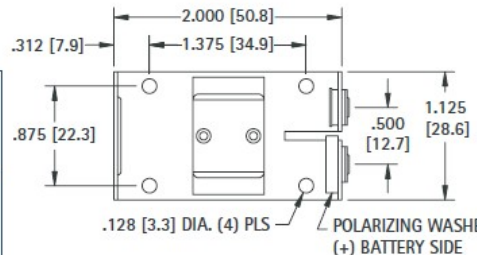
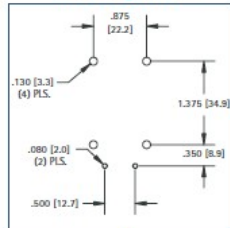

CAT. NO. 1290-79
Solder Lugs

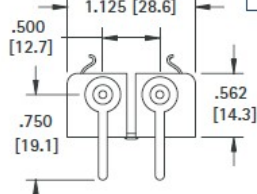

CAT. NO. 1291-79
PC Lugs

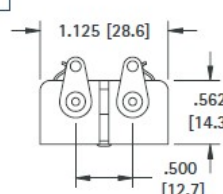

CAT. NO. 203-P
Solder Lugs

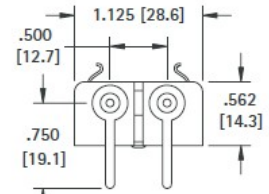

CAT. NO. 303-P
PC Lugs

NOTE: For battery thicknesses under .640 (16.3); specify **Cat. No. 1290** or **1291**.