

<b>NO MERCURY ADDED</b>	
<b>Description</b>	: Mercury & Cadmium Free Lithium / Iron Disulfide battery AAA Size
<b>Chemical System</b>	: Lithium / Iron Disulfide (Li/FeS <sub>2</sub> )
<b>Nominal Voltage</b>	: 1.5 Volts
<b>Nominal Dimensions</b>	: Ø10.5 mm x 44.5 mm
<b>Terminals</b>	: Protruded positive(+) and flat negative(-) contacts
<b>Jacket</b>	: Foil jacket
<b>Applications</b>	: All electronic devices, e.g. Digital cameras, photoflash, toys, portable lighting, digital audio
<b>Shelf life</b>	: 10 years at 21°C (80% rated capacity)
<b>Average Weight</b>	: 7.5g

### Cross References:

GP	JIS	IEC	Energizer	Duracell
24LF	FR03	FR03	L92	LF2400

Model No.: **GP24LF**

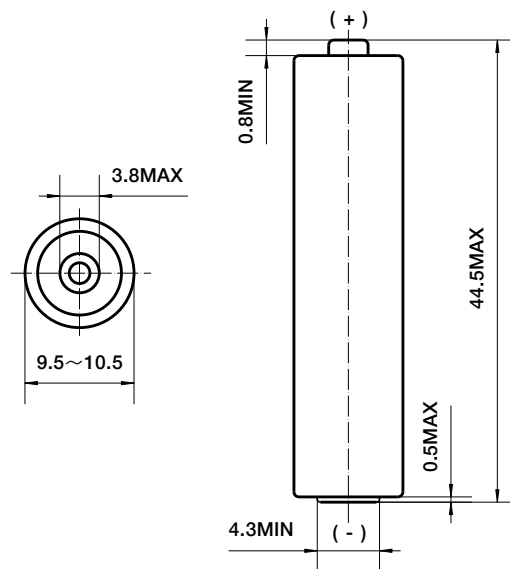

Unit : mm

### Constant Current Performance (21°C)

Typical Characteristics to 1.0 V

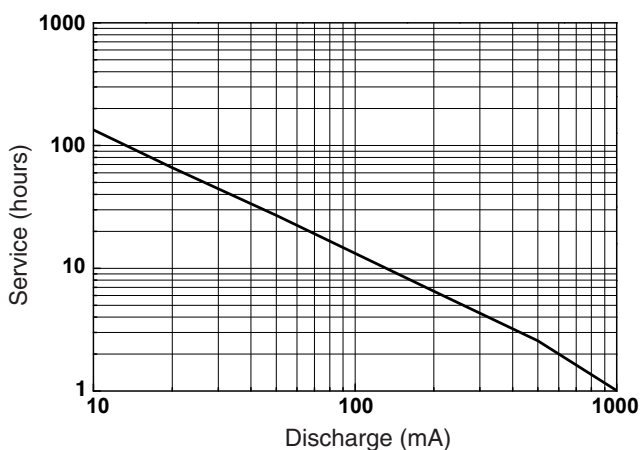

### Constant Power Performance (21°C)

Typical Characteristics to 1.0 V

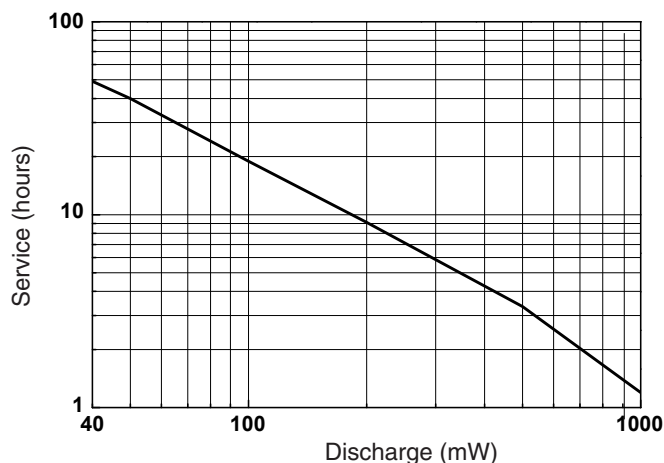

The information (subject to change without prior notice) contained in this document is for reference only and should not be used as a basis for product guarantee or warranty. For applications other than those described here, please consult your nearest GP Sales and Marketing Office or Distributors.

[www.gpbatteries.com](http://www.gpbatteries.com)

Manufacturer reserves the right to alter or amend the design, model and specification without prior notice.  
Copyright© GPI International Ltd. - All rights reserved

### High Drain Performance (21°C)

600 mA Continuous

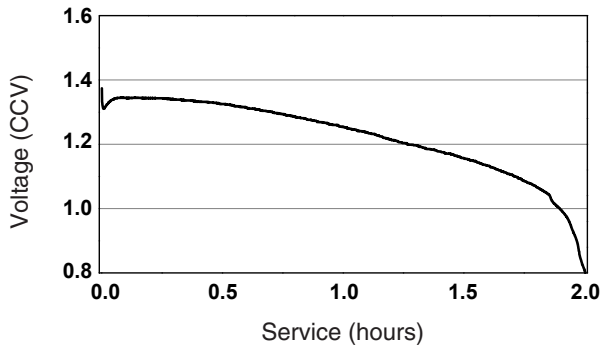

### Low Drain Performance (21°C)

50 mA Continuous

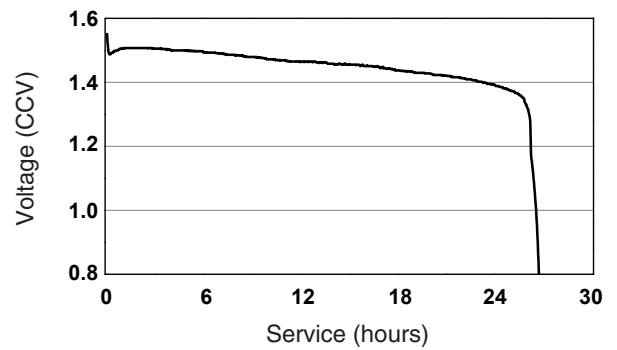

### Application Test (23±2°C)

Digital Still Camera  
1.2 W 2s/0.65 W 28s, 10T/hr

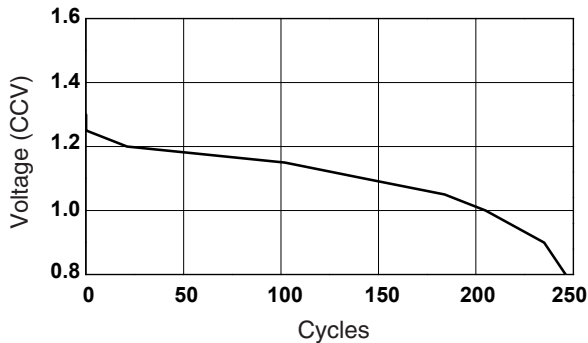

### Application Test (23±2°C)

High Intensity Lighting  
0.4 W 4m/15m, 8h/d

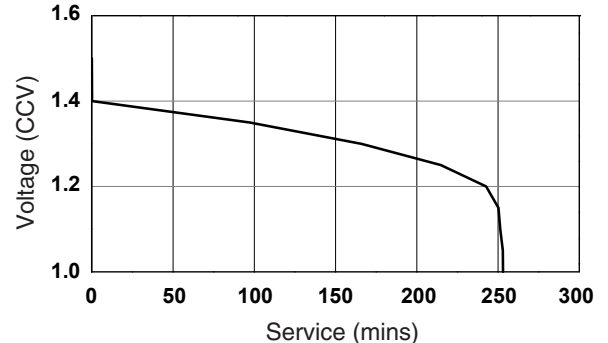

### Application Test (23±2°C)

Photo Flash 600 mA 10s/m, 1h/d      Light 5.1 ohm LIF

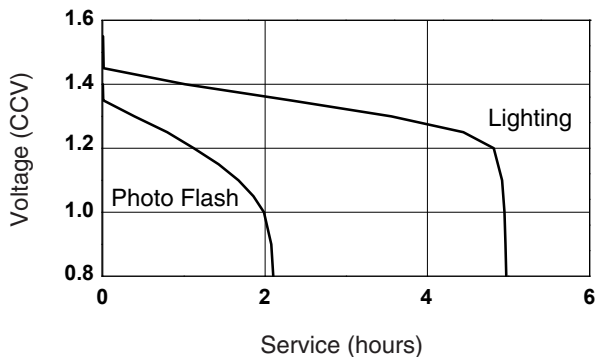

### Application Test (23±2°C)

Electronic Game/Digital Audio 100 mA, 1h/d      Remote 24 ohm 15s/m, 8h/d

