

Features

- Switching** Zero cross
- Output** Back to back SCR with internal snubber
- Input** DC with constant current control
- Applications** Resistive and inductive loads with $\cos\phi > 0.85$

Technical data

WG 280 D...	10 Z	25 Z	45 Z	50 Z
Input circuit				
Control voltage range	3...32 VDC			
Control current max.	12 mA			
Turn-off voltage min.	1 VDC			
Input resistance	constant current			
Output circuit				
Load voltage range	24...280 VAC			
Peak-off state voltage	600 V _{drm}			
Off-state leakage current	6 mA eff.		12 mA eff.	
Load current range	0,1...10 A	0,2...25 A	0,4...45 A	0,4...50 A
Surge current 1 half wave	110 A _{peak}	230 A _{peak}	500 A _{peak}	570 A _{peak}
I ² t for fusing	60 A ² s	260 A ² s	1250 A ² s	1620 A ² s
On-state voltage	1,6 V _{peak}			
Off-state (static) dV/dt	500 V/μs			
Snubber	47 Ω / 47 nF		47 Ω / 100 nF	
General data				
Turn-on time max.	11 ms			
Turn-off time max.	11 ms			
Line frequency range	47...63 Hz			
Isolation volt. between input/output	4.000 V			
Isolation volt. between input-output/base	2.500 V			
Isolation resistance	50 MΩ			
Operation temperature	-20...+80 °C			
Recommended varistor	SIOV-S20 K230			
Approvals	UL, VDE			

Technical data

WG 280 D...	75 Z	90 Z	110 Z	125 Z
Input circuit				
Control voltage range	3...32 VDC			
Control current max.	12 mA			
Turn-off voltage min.	1 VDC			
Input resistance	constant current			
Output circuit				
Load voltage range	24...280 VAC			
Peak-off state voltage	600 V _{drm}			
Off-state leakage current	12 mA eff.			
Load current range	0,4...75 A	0,4...90 A	0,4...110 A	0,4...125 A
Surge current 1 half wave	910 A _{peak}	1090 A _{peak}	1350 A _{peak}	1590 A _{peak}
I ² t for fusing	4150 A ² s	5980 A ² s	9100 A ² s	12650 A ² s
On-state voltage	1,6 V _{peak}			
Off-state (static) dV/dt	500 V/μs			
Snubber	47 Ω / 100 nF			
General data				
Turn-on time max.	11 ms			
Turn-off time max.	11 ms			
Line frequency range	47...63 Hz			
Isolation volt. between input/output	4.000 V			
Isolation volt. between input-output/base	2.500 V			
Isolation resistance	50 MΩ			
Operation temperature	-20...+80 °C			
Recommended varistor	SIOV-S20 K230			
Approvals	UL, VDE			

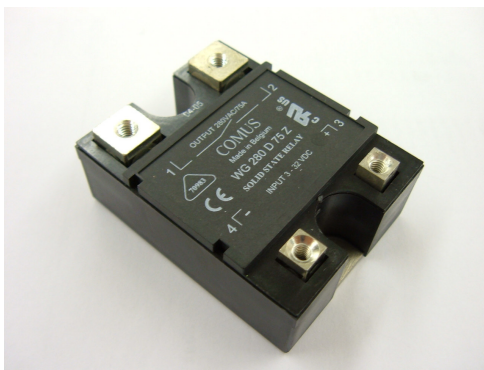

Features

Switching	Random
Output	Back to back SCR with internal snubber
Input	DC with constant current control
Applications	Inductive loads

Technical data

WG 280 D...	10 R	25 R	40 R	50 R
Input circuit				
Control voltage range	3...32 VDC			
Control current max.	12 mA			
Turn-off voltage min.	1 VDC			
Input resistance	constant current			
Output circuit				
Load voltage range	24...280 VAC			
Peak-off state voltage	600 V _{drm}			
Off-state leakage current	6 mA eff.		12 mA eff	
Load current range	0,1...10 A	0,2...25 A	0,4...40 A	0,4...50 A
Surge current 1 half wave	110 A _{peak}	230 A _{peak}	500 A _{peak}	570 A _{peak}
I ² t for fusing	60 A ² s	260 A ² s	1250 A ² s	1620 A ² s
On-state voltage	1,6 V _{peak}			
Off-state (static) dV/dt	500 V/μs			
Snubber	47 Ω / 47 nF		47 Ω / 100 nF	
General data				
Turn-on time max.	0,1 ms			
Turn-off time max.	11 ms			
Line frequency range	47...63 Hz			
Isolation volt. between input/output	4.000 V			
Isolation volt. between input-output/base	2.500 V			
Isolation resistance	50 MΩ			
Operation temperature	-20...+80 °C			
Recommended varistor	SIOV-S20 K230			
Approvals	UL, VDE			

Technical data

WG 280 D...	75 R	90 R	110 R	125 R
Input circuit				
Control voltage range	3...32 VDC			
Control current max.	12 mA			
Turn-off voltage min.	1 VDC			
Input resistance	constant current			
Output circuit				
Load voltage range	24...280 VAC			
Peak-off state voltage	600 V _{drm}			
Off-state leakage current	12 mA eff.			
Load current range	0,4...75 A	0,4...90 A	0,4...110 A	0,4...125 A
Surge current 1 half wave	910 A _{peak}	1090 A _{peak}	1350 A _{peak}	1590 A _{peak}
I ² t for fusing	4150 A ² s	5980 A ² s	9100 A ² s	12650 A ² s
On-state voltage	1,6 V _{peak}			
Off-state (static) dV/dt	500 V/μs			
Snubber	47 Ω / 100 nF			
General data				
Turn-on time max.	0,1 ms			
Turn-off time max.	11 ms			
Line frequency range	47...63 Hz			
Isolation volt. between input/output	4.000 V			
Isolation volt. between input-output/base	2.500 V			
Isolation resistance	50 MΩ			
Operation temperature	-20...+80 °C			
Recommended varistor	SIOV-S20 K230			
Approvals	UL, VDE			

Dimensions in mm & circuit diagram

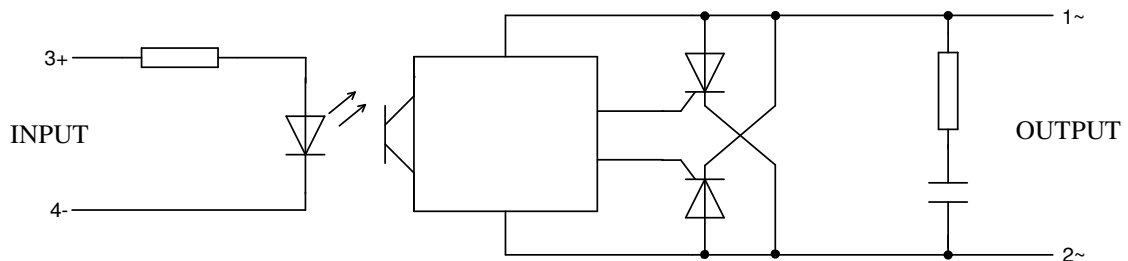
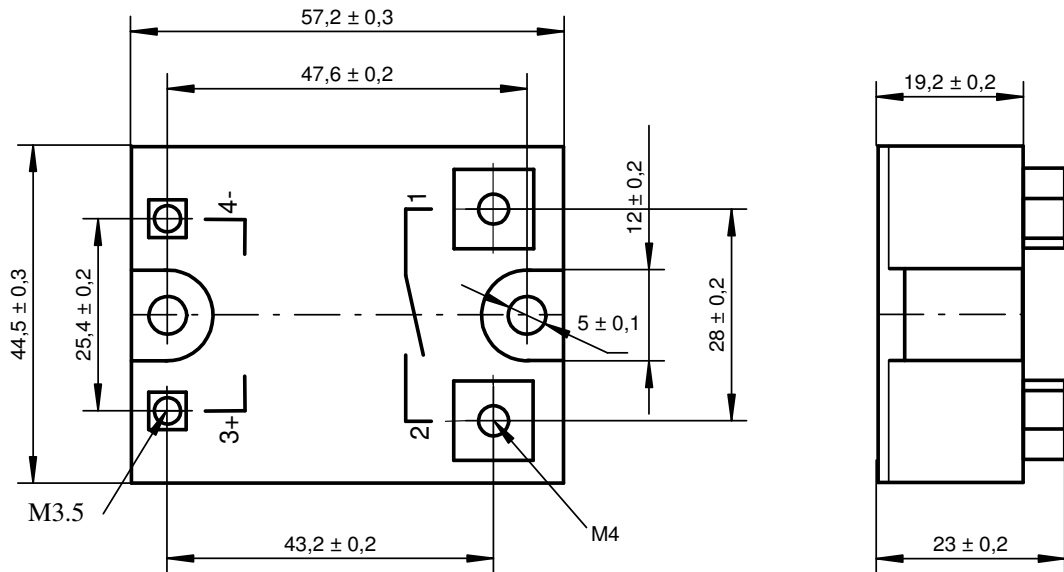

Housing specification

Weight	Approx. 80 gr unpotted , 100 gr potted (optional)
Housing material	Glass filled polyester
Potting compound (optional)	UL recognized Epoxy
Base plate	10 ... 45 A : Aluminium 50 ... 125A : Aluminium , nickel plated
Terminals	Input : M4-screws Output : M3,5-screws

Derating-diagrams

UL recognised components: suitable for a max. surrounding air temperature of 40°C.
 For use at other ambient temperatures, check the derating diagrams.

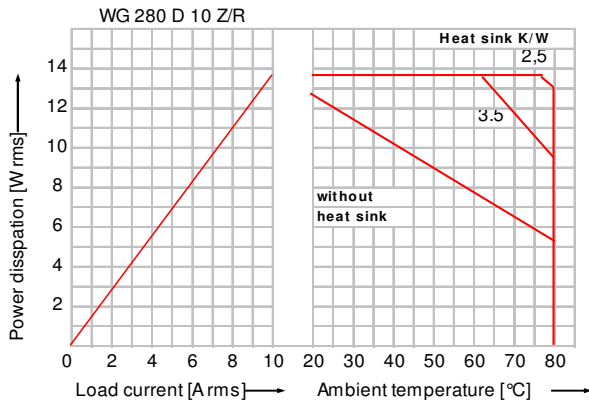

**Number of SSR per heatsink/
load current per SSR**

Heat sink	1 SSR	2 SSR	3 SSR
WG K1/100	10 A	8 A	
WG K2/100	10 A	10 A	
WG K3/160	10 A	10 A	10 A
WG K4/160L	10 A	10 A	10 A
WG K5/80	10 A		

Values for 40°C enclosure-temperature and mounted with conduction paste between the SSR and the heat sink

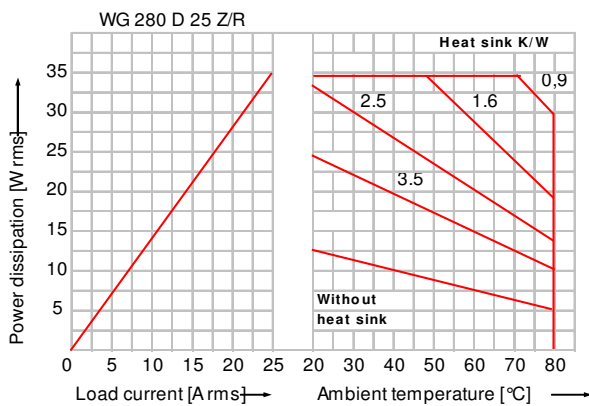

**Number of SSR per heatsink/
load current per SSR**

Heat sink	1 SSR	2 SSR	3 SSR
WG K1/100	13 A	8 A	
WG K2/100	19 A	12 A	
WG K3/160	25 A	25 A	19 A
WG K4/160L	25 A	25 A	25 A
WG K5/80	24 A		

Values for 40°C enclosure-temperature and mounted with conduction paste between the SSR and the heat sink

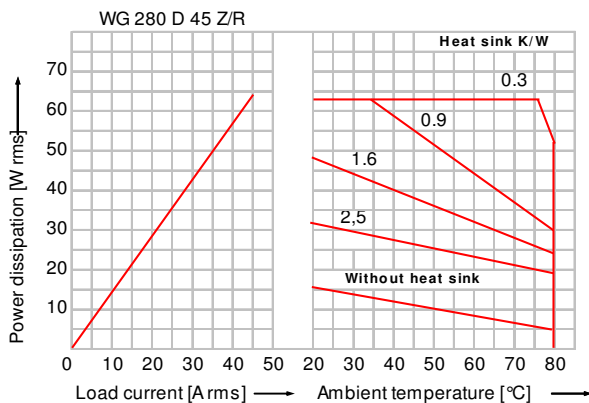

**Number of SSR per heatsink/
load current per SSR**

Heat sink	1 SSR	2 SSR	3 SSR
WG K1/100	13 A	8 A	
WG K2/100	19 A	12 A	
WG K3/160	42 A	26 A	19 A
WG K4/160L	45 A	45 A	40 A
WG K5/80	24 A		

Values for 40°C enclosure-temperature and mounted with conduction paste between the SSR and the heat sink

Derating-diagrams

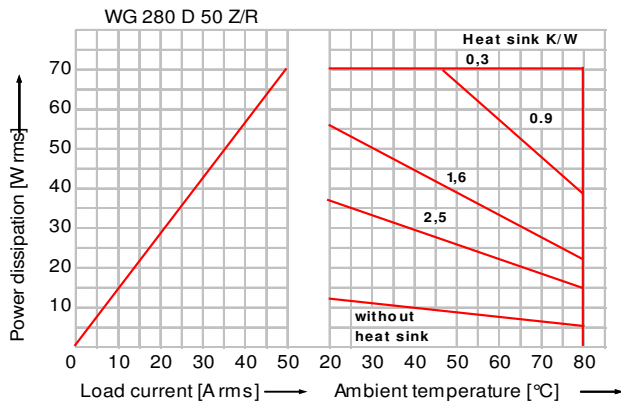

**Number of SSR per heatsink/
load current per SSR**

Heat sink	1 SSR	2 SSR	3 SSR
WG K1/100	13 A	8 A	
WG K2/100	20 A	12 A	
WG K3/160	50 A	31 A	20 A
WG K4/160L	50 A	50 A	50 A
WG K5/80	25A		

Values for 40°C enclosure-temperature and mounted with conduction paste between the SSR and the heat sink

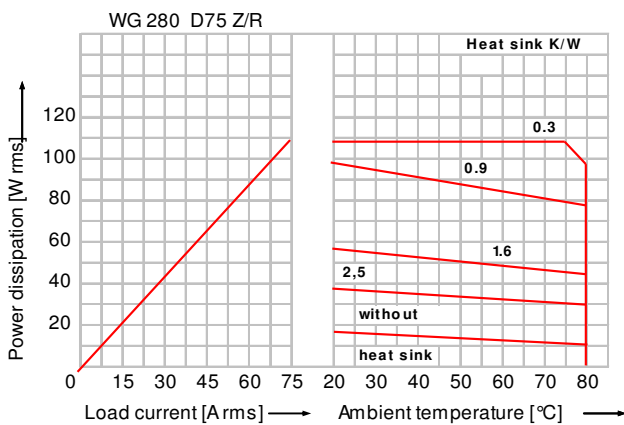

**Number of SSR per heatsink/
load current per SSR**

Heat sink	1 SSR	2 SSR	3 SSR
WG K1/100	13 A	8 A	
WG K2/100	20 A	12 A	
WG K3/160	55 A	32 A	20 A
WG K4/160L	75 A	75 A	57 A
WG K5/80	25 A		

Values for 40°C enclosure-temperature and mounted with conduction paste between the SSR and the heat sink

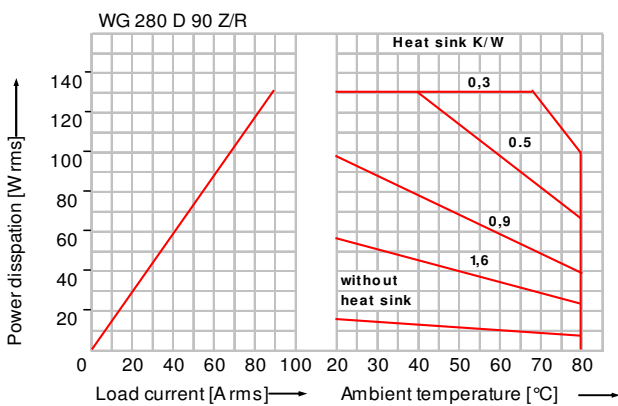

**Number of SSR per heatsink/
load current per SSR**

Heat sink	1 SSR	2 SSR	3 SSR
WG K1/100	13 A	8 A	
WG K2/100	20 A	12 A	
WG K3/160	55 A	32 A	20 A
WG K4/160L	90 A	90 A	57 A
WG K5/80	25 A		

Values for 40°C enclosure-temperature and mounted with conduction paste between the SSR and the heat sink

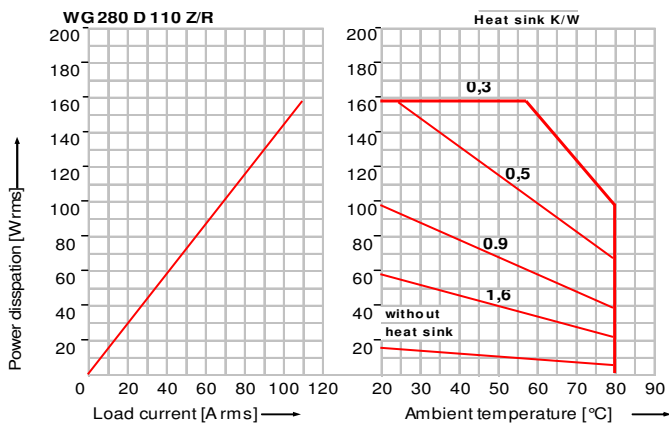

**Number of SSR per heatsink/
load current per SSR**

Heat sink	1 SSR	2 SSR
WG K1/100	13 A	8 A
WG K2/100	21 A	12 A
WG K3/160	58 A	33 A
WG K4/160L	110 A	85 A
WG K5/80	34 A	

Values for 40°C enclosure-temperature and mounted with conduction paste between the SSR and the heat sink

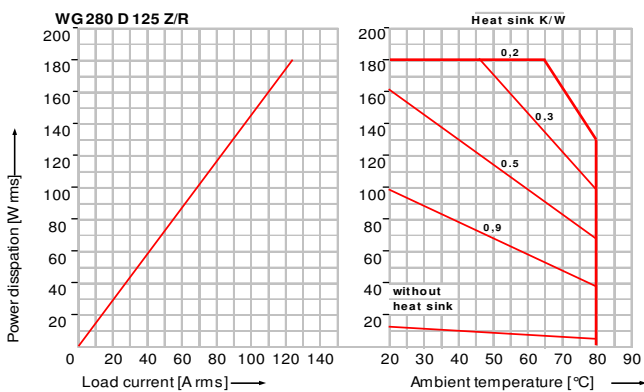

**Number of SSR per heatsink/
load current per SSR**

Heat sink	1 SSR	2 SSR
WG K1/100	13 A	8 A
WG K2/100	21 A	12 A
WG K3/160	58 A	33 A
WG K4/160L	125 A	85 A
WG K5/80	34 A	

Values for 40°C enclosure-temperature and mounted with conduction paste between the SSR and the heat sink

Ordering

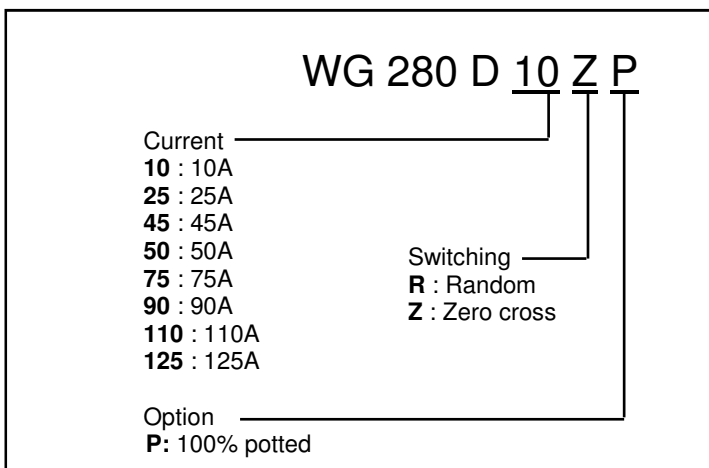

Description	Part Number
Protective case small	8440 5700 110
Thermal Conducting paste	8406 0180 020
Heat sink WG K1/100	5981 5701 100
Heat sink WG K2/100	5981 5701 110
Heat sink WG K3/160	5981 5701 370
Heat sink WG K4/160L	5981 5701 371
Heat sink WG K5/80	5981 5701 372
Mounting plate DIN rail	5981 5701 430

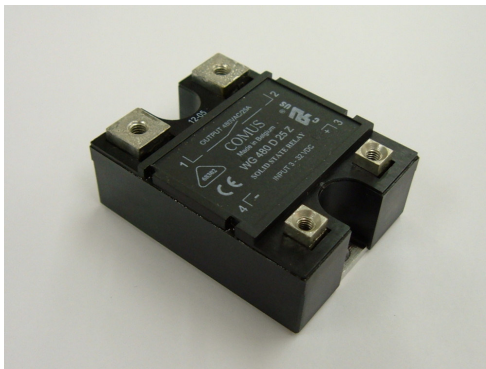

Features

- Switching** Zero cross
- Output** Back to back SCR with internal snubber
- Input** DC with constant current control
- Applications** Resistive and inductive loads with $\cos\phi > 0.85$

Technical data

WG 480 D...	10 Z	25 Z	40 Z	50 Z
Input circuit				
Control voltage range	3...32 VDC			
Control current max.	22 mA			
Turn-off voltage min.	1 VDC			
Input resistance	constant current			
Output circuit				
Load voltage range	24...530 VAC			
Peak-off state voltage	1200 V _{drm} (integrated overvoltage protection effective above 1000V)			
Off-state leakage current	10 mA eff.			
Load current range	0,1...10 A	0,2...25 A	0,4...40 A	0,4...50 A
Surge current 1 half wave	110 A _{peak}	230 A _{peak}	500 A _{peak}	570 A _{peak}
I ² t for fusing	60 A ² s	260 A ² s	1250 A ² s	1620 A ² s
On-state voltage	1,6 V _{peak}			
Off-state (static) dV/dt	500 V/μs			
Snubber	47 Ω / 22 nF			
General data				
Turn-on time max.	11 ms			
Turn-off time max.	11 ms			
Line frequency range	47...63 Hz			
Isolation volt. between input/output	4.000 V			
Isolation volt. between input-output/base	2.500 V			
Isolation resistance	50 MΩ			
Operation temperature	-20...+80 °C			
Recommended varistor	SIOV-S20 K420			
Approvals	UL, VDE			

Technical data				
WG 480 D...	75 Z	90 Z	110 Z	125 Z
Input circuit				
Control voltage range	3...32 VDC			
Control current max.	22 mA			
Turn-off voltage min.	1 VDC			
Input resistance	constant current			
Output circuit				
Load voltage range	24...530 VAC			
Peak-off state voltage	1200 V _{drm} (integrated overvoltage protection effective above 1000V)			
Off-state leakage current	10 mA eff.			
Load current range	0,4...75 A	0,4...90 A	0,4...110 A	0,4...125 A
Surge current 1 half wave	910 A _{peak}	1090 A _{peak}	1350 A _{peak}	1590 A _{peak}
I ² t for fusing	4150 A ² s	5980 A ² s	9100 A ² s	12650 A ² s
On-state voltage	1,6 V _{peak}			
Off-state (static) dV/dt	500 V/μs			
Snubber	47 Ω / 22 nF			
General data				
Turn-on time max.	11 ms			
Turn-off time max.	11 ms			
Line frequency range	47...63 Hz			
Isolation volt. between input/output	4.000 V			
Isolation volt. between input-output/base	2.500 V			
Isolation resistance	50 MΩ			
Operation temperature	-20...+80 °C			
Recommended varistor	SIOV-S20 K420			
Approvals	UL, VDE			



Features

- Switching** Zero cross
- Output** Back to back SCR with internal snubber
- Input** DC with constant current control
- Applications** Inductive loads

Technical data

WG 480 D...	10 R	25 R	40 R	50 R
Input circuit				
Control voltage range	3...32 VDC			
Control current max.	22 mA			
Turn-off voltage min.	1 VDC			
Input resistance	constant current			
Output circuit				
Load voltage range	48...530 VAC			
Peak-off state voltage	1200 V _{drm} (integrated overvoltage protection effective above 1000V)			
Off-state leakage current	10 mA eff.			
Load current range	0,1...10 A	0,2...25 A	0,4...40 A	0,4...50 A
Surge current 1 half wave	110 A _{peak}	230 A _{peak}	500 A _{peak}	570 A _{peak}
I ² t for fusing	60 A ² s	260 A ² s	1250 A ² s	1620 A ² s
On-state voltage	1,6 V _{peak}			
Off-state (static) dV/dt	500 V/μs			
Snubber	47 Ω / 22 nF			
General data				
Turn-on time max.	0,1 ms			
Turn-off time max.	11 ms			
Line frequency range	47...63 Hz			
Isolation volt. between input/output	4.000 V			
Isolation volt. between input-output/base	2.500 V			
Isolation resistance	50 MΩ			
Operation temperature	-20...+80 °C			
Recommended varistor	SIOV-S20 K420			
Approvals	UL, VDE			

Technical data				
WG 480 D...	75 R	90 R	110 R	125 R
Input circuit				
Control voltage range	3...32 VDC			
Control current max.	22 mA			
Turn-off voltage min.	1 VDC			
Input resistance	constant current			
Output circuit				
Load voltage range	48...530 VAC			
Peak-off state voltage	1200 V _{drm} (integrated overvoltage protection effective above 1000V)			
Off-state leakage current	10 mA eff.			
Load current range	0,4...75 A	0,4...90 A	0,4...110 A	0,4...125 A
Surge current 1 half wave	910 A _{peak}	1090 A _{peak}	1350 A _{peak}	1590 A _{peak}
I ² t for fusing	4150 A ² s	5980 A ² s	9100 A ² s	12650 A ² s
On-state voltage	1,6 V _{peak}			
Off-state (static) dV/dt	500 V/μs			
Snubber	47 Ω / 22 nF			
General data				
Turn-on time max.	0,1 ms			
Turn-off time max.	11 ms			
Line frequency range	47...63 Hz			
Isolation volt. between input/output	4.000 V			
Isolation volt. between input-output/base	2.500 V			
Isolation resistance	50 MΩ			
Operation temperature	-20...+80 °C			
Recommended varistor	SIOV-S20 K420			
Approvals	UL, VDE			

Dimensions in mm & circuit diagram

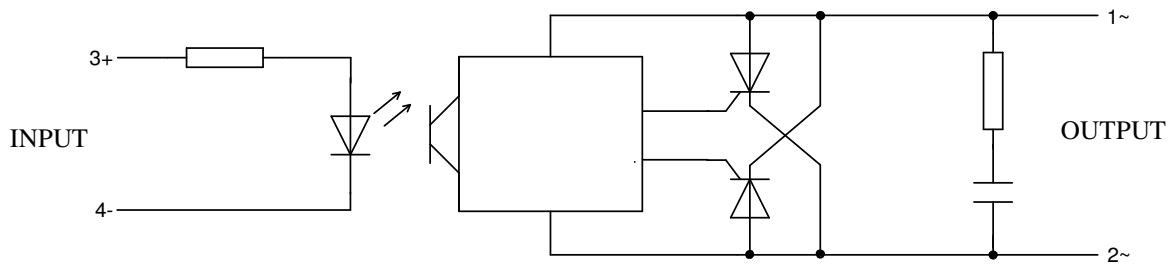
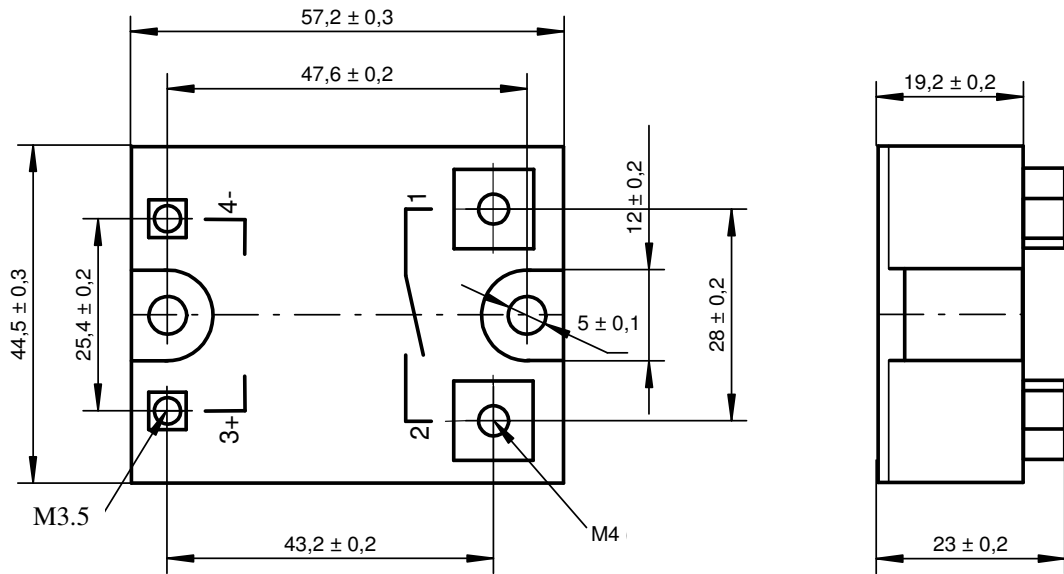

Housing specification

Weight	Approx. 80 gr unpotted , 100 gr potted (optional)
Housing material	Glass filled polyester
Potting compound (optional)	UL recognized Epoxy
Base plate	10 ... 45 A : Aluminium 50 ... 125A : Aluminium , nickel plated
Terminals	Input : M3,5-screws Output : M4-screws

Derating-diagrams

UL recognised components: suitable for a max. surrounding air temperature of 40°C.
 For use at other ambient temperatures, check the derating diagrams.

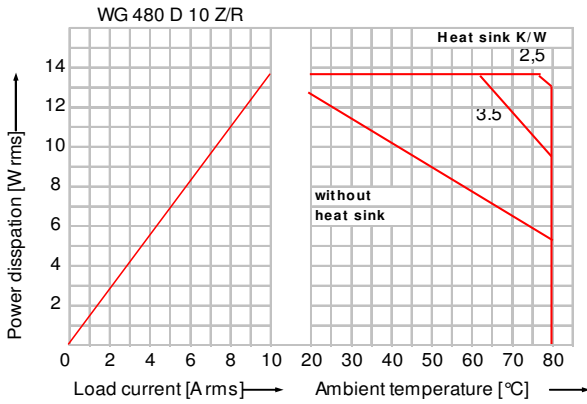

**Number of SSR per heatsink/
load current per SSR**

Heat sink	1 SSR	2 SSR	3 SSR
WG K1/100	10 A	8 A	
WG K2/100	10 A	10 A	
WG K3/160	10 A	10 A	10 A
WG K4/160L	10 A	10 A	10 A
WG K5/80	10 A		

Values for 40°C enclosure-temperature and mounted with conduction paste between the SSR and the heat sink

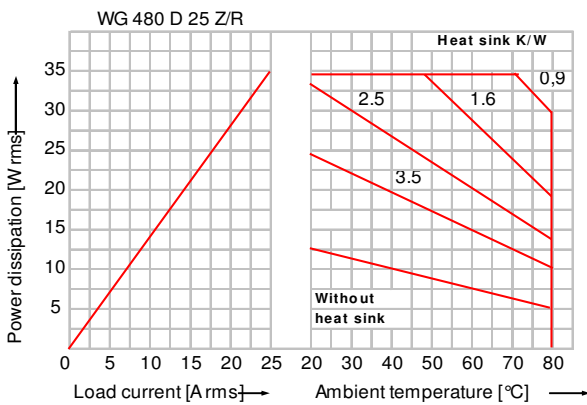

**Number of SSR per heatsink/
load current per SSR**

Heat sink	1 SSR	2 SSR	3 SSR
WG K1/100	13 A	8 A	
WG K2/100	19 A	12 A	
WG K3/160	25 A	25 A	19 A
WG K4/160L	25 A	25 A	25 A
WG K5/80	24 A		

Values for 40°C enclosure-temperature and mounted with conduction paste between the SSR and the heat sink

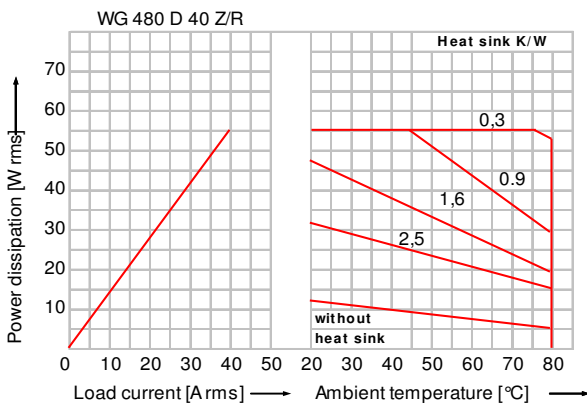

**Number of SSR per heatsink/
load current per SSR**

Heat sink	1 SSR	2 SSR	3 SSR
WG K1/100	13 A	8 A	
WG K2/100	19 A	12 A	
WG K3/160	42 A	26 A	19 A
WG K4/160L	45 A	45 A	40 A
WG K5/80	24 A		

Values for 40°C enclosure-temperature and mounted with conduction paste between the SSR and the heat sink

Derating-diagrams

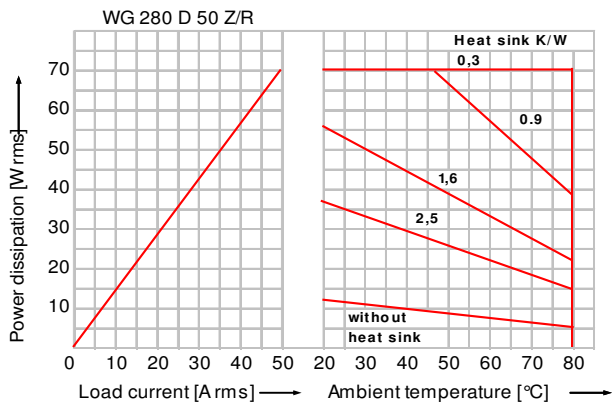

	Number of SSR per heatsink/ load current per SSR		
Heat sink	1 SSR	2 SSR	3 SSR
WG K1/100	13 A	8 A	
WG K2/100	20 A	12 A	
WG K3/160	50 A	31 A	20 A
WG K4/160L	50 A	50 A	50 A
WG K5/80	25 A		

Values for 40°C enclosure-temperature and mounted with conduction paste between the SSR and the heat sink

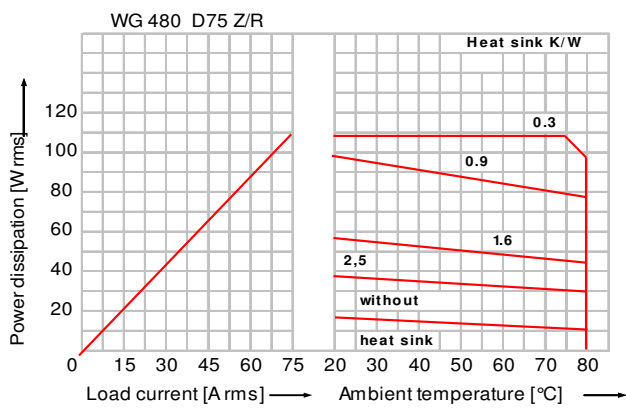

	Number of SSR per heatsink/ load current per SSR		
Heat sink	1 SSR	2 SSR	3 SSR
WG K1/100	13 A	8 A	
WG K2/100	20 A	12 A	
WG K3/160	55 A	32 A	20 A
WG K4/160L	75 A	75 A	57 A
WG K5/80	25 A		

Values for 40°C enclosure-temperature and mounted with conduction paste between the SSR and the heat sink

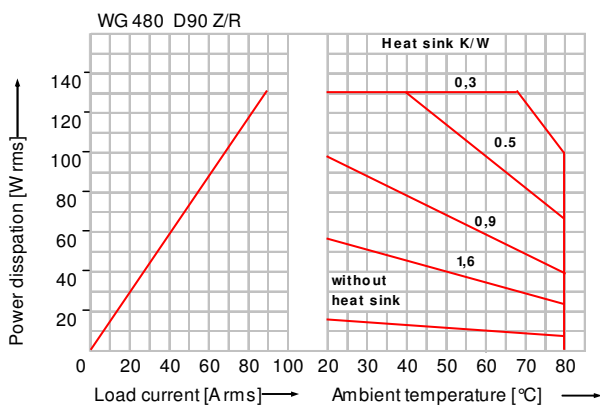

	Number of SSR per heatsink/ load current per SSR		
Heat sink	1 SSR	2 SSR	3 SSR
WG K1/100	13 A	8 A	
WG K2/100	20 A	12 A	
WG K3/160	55 A	32 A	20 A
WG K4/160L	90 A	90 A	57 A
WG K5/80	25 A		

Values for 40°C enclosure-temperature and mounted with conduction paste between the SSR and the heat sink

Derating-Diagrams

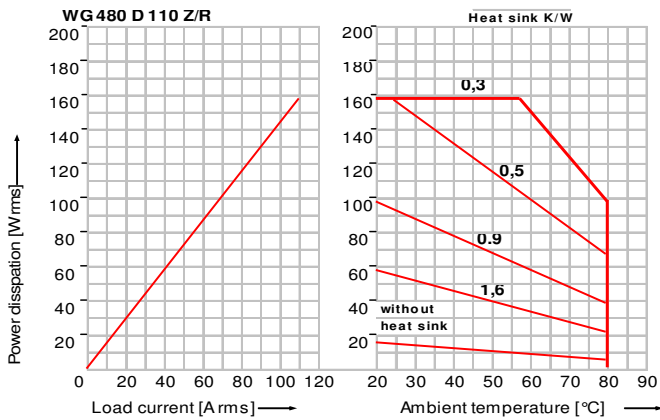

Number of SSR per heatsink/
load current per SSR

Heat sink	1 SSR	2 SSR
WG K1/100	13 A	8 A
WG K2/100	21 A	12 A
WG K3/160	58 A	30 A
WG K4/160L	110 A	85 A
WG K5/80	34 A	

Values for 40°C enclosure-temperature and mounted with conduction paste between the SSR and the heat sink

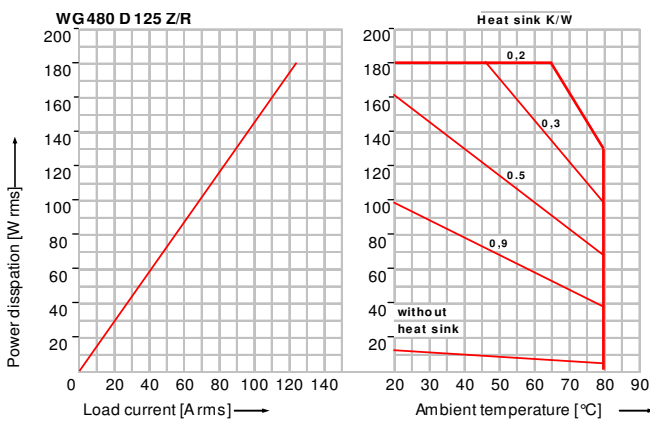

Number of SSR per heatsink/
load current per SSR

Heat sink	1 SSR	2 SSR
WG K1/100	13 A	8 A
WG K2/100	21 A	12 A
WG K3/160	58 A	33 A
WG K4/160L	125 A	85 A
WG K5/80	34 A	

Values for 40°C enclosure-temperature and mounted with conduction paste between the SSR and the heat sink

Ordering

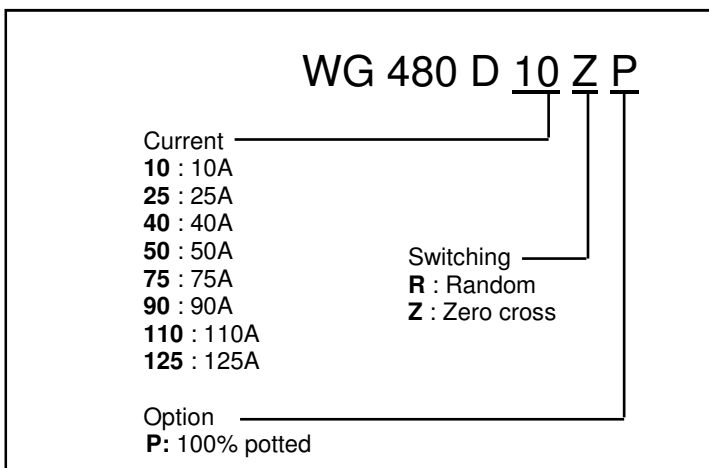

Description	Part Number
Protective case small	8440 5700 110
Thermal Conducting paste	8406 0180 020
Heat sink WG K1/100	5981 5701 100
Heat sink WG K2/100	5981 5701 110
Heat sink WG K3/160	5981 5701 370
Heat sink WG K4/160L	5981 5701 371
Heat sink WG K5/80	5981 5701 372
Mounting plate DIN rail	5981 5701 430

Solid State Relays

Datasheet WG 660 D...Z

Comus International Bvba
 Overhaamlaan 40
 3700 Tongeren, Belgium
 Phone: +32 12390400
 Fax: +32 12235754
 Email: info@comus.be
 www.comus.be



Features

- Switching** Zero cross
- Output** Back to back SCR with internal snubber
- Input** DC with constant current control
- Applications** Resistive and inductive loads with $\cos\phi > 0.85$

Technical data

WG 660 D...	10 Z	25 Z	40 Z	50 Z
Input circuit				
Control voltage range	3...32 VDC			
Control current max.	22 mA			
Turn-off voltage min.	1 VDC			
Input resistance	constant current			
Output circuit				
Load voltage range	24...660 VAC			
Peak-off state voltage	1600 V _{drm} (integrated overvoltage protection effective above 1200V)			
Off-state leakage current	10 mA eff.			
Load current range	0,1...10 A	0,2...25 A	0,4...40 A	0,4...50 A
Surge current 1 half wave	110 A _{peak}	230 A _{peak}	500 A _{peak}	570 A _{peak}
I ² t for fusing	60 A ² s	260 A ² s	1250 A ² s	1620 A ² s
On-state voltage	1,6 V _{peak}			
Off-state (static) dV/dt	500 V/μs			
Snubber	47 Ω / 5 nF			
General data				
Turn-on time max.	11 ms			
Turn-off time max.	11 ms			
Line frequency range	47...63 Hz			
Isolation volt. between input/output	4.000 V			
Isolation volt. between input-output/base	2.500 V			
Isolation resistance	50 MΩ			
Operation temperature	-20...+80 °C			
Recommended varistor	SIOV-S20 K625			
Approvals	UL, VDE			

Technical data				
WG 660 D...	75 Z	90 Z	110 Z	125 Z
Input circuit				
Control voltage range	3...32 VDC			
Control current max.	22 mA			
Turn-off voltage min.	1 VDC			
Input resistance	constant current			
Output circuit				
Load voltage range	24...660 VAC			
Peak-off state voltage	1600 V _{drm} (integrated overvoltage protection effective above 1200V)			
Off-state leakage current	10 mA eff.			
Load current range	0,4...75 A	0,4...90 A	0,4...110 A	0,4...125 A
Surge current 1 half wave	910 A _{peak}	1090 A _{peak}	1350 A _{peak}	1590 A _{peak}
I ² t for fusing	4150 A ² s	5980 A ² s	9100 A ² s	12650 A ² s
On-state voltage	1,6 V _{peak}			
Off-state (static) dV/dt	500 V/μs			
Snubber	47 Ω / 5 nF			
General data				
Turn-on time max.	11 ms			
Turn-off time max.	11 ms			
Line frequency range	47...63 Hz			
Isolation volt. between input/output	4.000 V			
Isolation volt. between input-output/base	2.500 V			
Isolation resistance	50 MΩ			
Operation temperature	-20...+80 °C			
Recommended varistor	SIOV-S20 K625			
Approvals	UL, VDE			



Features

- Switching** Zero cross
- Output** Back to back SCR with internal snubber
- Input** DC with constant current control
- Applications** Inductive loads

Technical data

WG 660 D...	10 R	25 R	40 R	50 R
Input circuit				
Control voltage range	3...32 VDC			
Control current max.	22 mA			
Turn-off voltage min.	1 VDC			
Input resistance	constant current			
Output circuit				
Load voltage range	48...660 VAC			
Peak-off state voltage	1600 V _{drm} (integrated overvoltage protection effective above 1200V)			
Off-state leakage current	10 mA eff.			
Load current range	0,1...10 A	0,2...25 A	0,4...40 A	0,4...50 A
Surge current 1 half wave	110 A _{peak}	230 A _{peak}	500 A _{peak}	570 A _{peak}
I ² t for fusing	60 A ² s	260 A ² s	1250 A ² s	1620 A ² s
On-state voltage	1,6 V _{peak}			
Off-state (static) dV/dt	500 V/μs			
Snubber	47 Ω / 5 nF			
General data				
Turn-on time max.	0,1 ms			
Turn-off time max.	11 ms			
Line frequency range	47...63 Hz			
Isolation volt. between input/output	4.000 V			
Isolation volt. between input-output/base	2.500 V			
Isolation resistance	50 MΩ			
Operation temperature	-20...+80 °C			
Recommended varistor	SIOV-S20 K625			
Approvals	UL, VDE			

Technical data				
WG 660 D...	75 R	90 R	110 R	125 R
Input circuit				
Control voltage range	3...32 VDC			
Control current max.	22 mA			
Turn-off voltage min.	1 VDC			
Input resistance	constant current			
Output circuit				
Load voltage range	48...660 VAC			
Peak-off state voltage	1600 V _{drm} (integrated overvoltage protection effective above 1200V)			
Off-state leakage current	10 mA eff.			
Load current range	0,4...75 A	0,4...90 A	0,4...110 A	0,4...125 A
Surge current 1 half wave	910 A _{peak}	1090 A _{peak}	1350 A _{peak}	1590 A _{peak}
I ² t for fusing	4150 A ² s	5980 A ² s	9100 A ² s	12650 A ² s
On-state voltage	1,6 V _{peak}			
Off-state (static) dV/dt	500 V/μs			
Snubber	47 Ω / 5 nF			
General data				
Turn-on time max.	0,1 ms			
Turn-off time max.	11 ms			
Line frequency range	47...63 Hz			
Isolation volt. between input/output	4.000 V			
Isolation volt. between input-output/base	2.500 V			
Isolation resistance	50 MΩ			
Operation temperature	-20...+80 °C			
Recommended varistor	SIOV-S20 K625			
Approvals	UL, VDE			

Dimensions in mm & circuit diagram

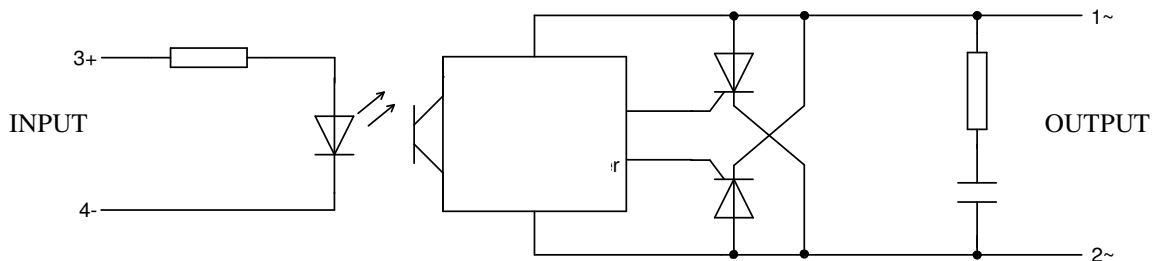
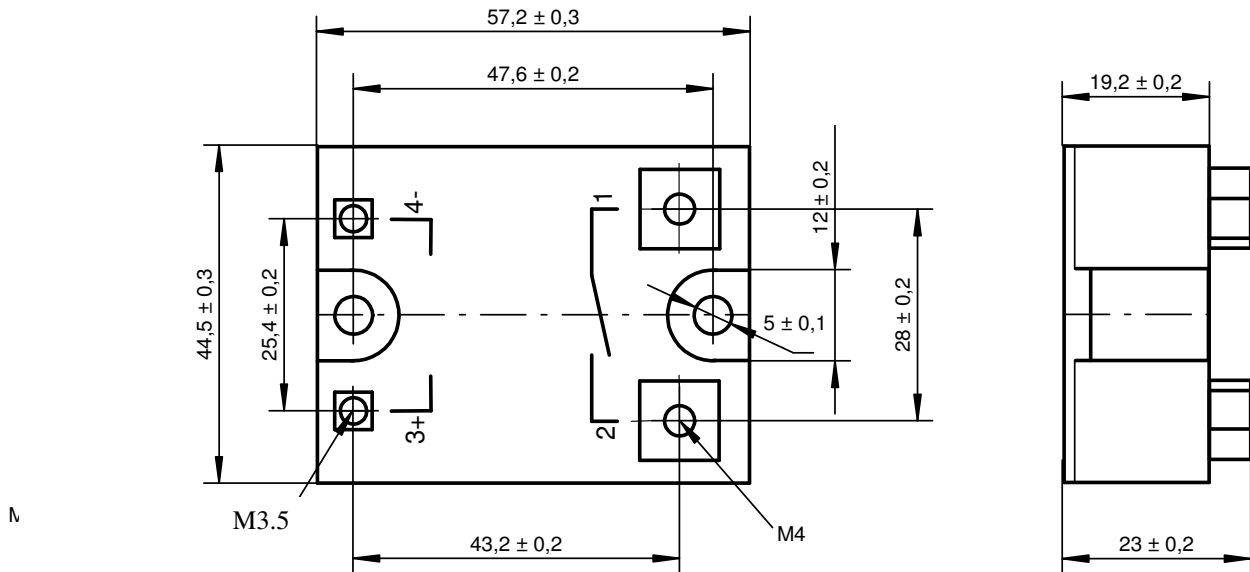

Housing specification

Weight	Approx. 80 gr unpotted , 100 gr potted (optional)
Housing material	Glass filled polyester
Potting compound (optional)	UL recognized Epoxy
Base plate	10 ... 45 A : Aluminium 50 ... 125A : Aluminium , nickel plated
Terminals	Input : M3,5-screws Output : M4-screws

Derating-diagrams

UL recognised components: suitable for a max. surrounding air temperature of 40°C.
 For use at other ambient temperatures, check the derating diagrams.

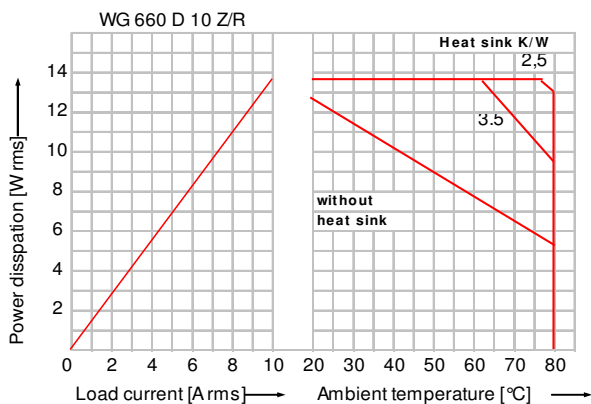

**Number of SSR per heatsink/
load current per SSR**

Heat sink	1 SSR	2 SSR	3 SSR
WG K1/100	10 A	8 A	
WG K2/100	10 A	10 A	
WG K3/160	10 A	10 A	10 A
WG K4/160L	10 A	10 A	10 A
WG K5/80	10 A		

Values for 40°C enclosure-temperature and mounted with conduction paste between the SSR and the heat sink

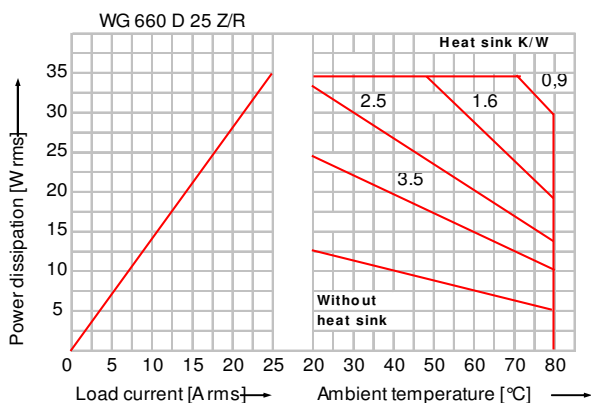

**Number of SSR per heatsink/
load current per SSR**

Heat sink	1 SSR	2 SSR	3 SSR
WG K1/100	13 A	8 A	
WG K2/100	19 A	12 A	
WG K3/160	25 A	25 A	19 A
WG K4/160L	25 A	25 A	25 A
WG K5/80	24 A		

Values for 40°C enclosure-temperature and mounted with conduction paste between the SSR and the heat sink

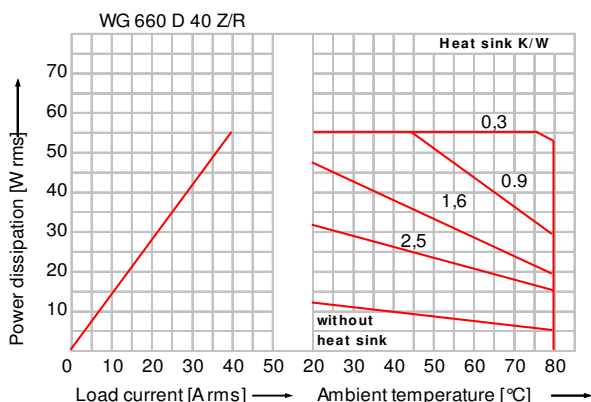

**Number of SSR per heatsink/
load current per SSR**

Heat sink	1 SSR	2 SSR	3 SSR
WG K1/100	13 A	8 A	
WG K2/100	19 A	12 A	
WG K3/160	42 A	26 A	19 A
WG K4/160L	45 A	45 A	40 A
WG K5/80	24 A		

Values for 40°C enclosure-temperature and mounted with conduction paste between the SSR and the heat sink

Derating-diagrams

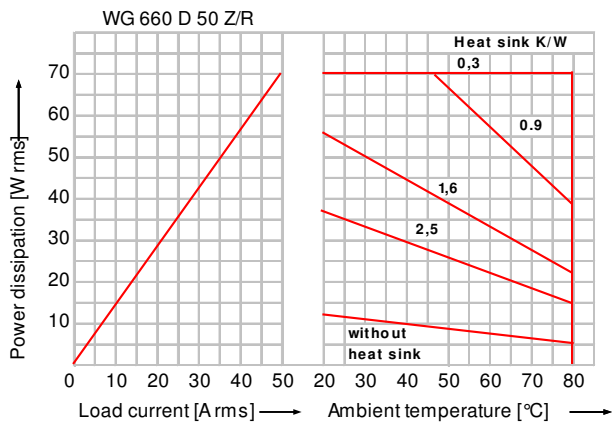

**Number of SSR per heatsink/
load current per SSR**

Heat sink	1 SSR	2 SSR	3 SSR
WG K1/100	13 A	8 A	
WG K2/100	20 A	12 A	
WG K3/160	50 A	31 A	20 A
WG K4/160L	50 A	50 A	50 A
WG K5/80	25 A		

Values for 40°C enclosure-temperature and mounted with conduction paste between the SSR and the heat sink

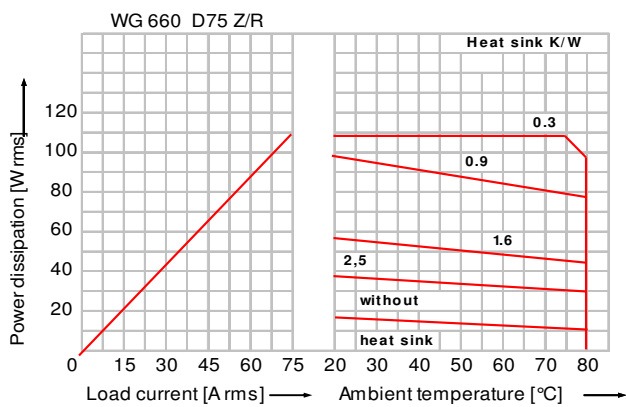

**Number of SSR per heatsink/
load current per SSR**

Heat sink	1 SSR	2 SSR	3 SSR
WG K1/100	13 A	8 A	
WG K2/100	20 A	12 A	
WG K3/160	55 A	32 A	20 A
WG K4/160L	75 A	75 A	57 A
WG K5/80	25 A		

Values for 40°C enclosure-temperature and mounted with conduction paste between the SSR and the heat sink

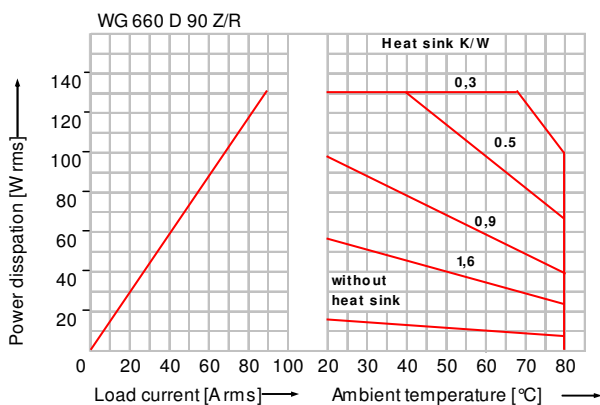

**Number of SSR per heatsink/
load current per SSR**

Heat sink	1 SSR	2 SSR	3 SSR
WG K1/100	13 A	8 A	
WG K2/100	20 A	12 A	
WG K3/160	55 A	32 A	20 A
WG K4/160L	90 A	90 A	57 A
WG K5/80	25 A		

Values for 40°C enclosure-temperature and mounted with conduction paste between the SSR and the heat sink

Derating-diagrams

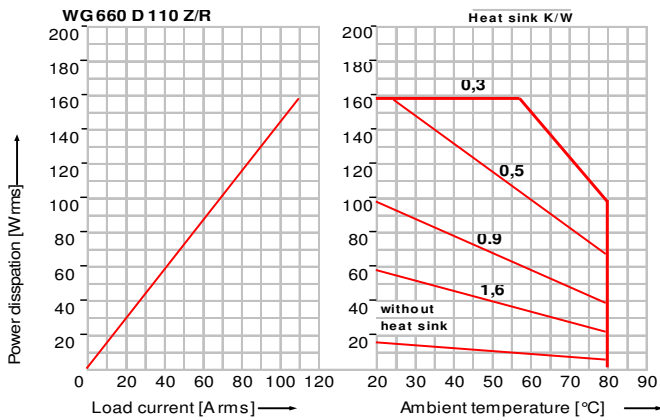

Number of SSR per heatsink/
load current per SSR

Heat sink	1 SSR	2 SSR
WG K1/100	13 A	8 A
WG K2/100	21 A	12 A
WG K3/160	58 A	33 A
WG K4/160L	110 A	85 A
WG K5/80	34 A	

Values for 40°C enclosure-temperature and mounted with Conduction paste between the SSR and the heat sink

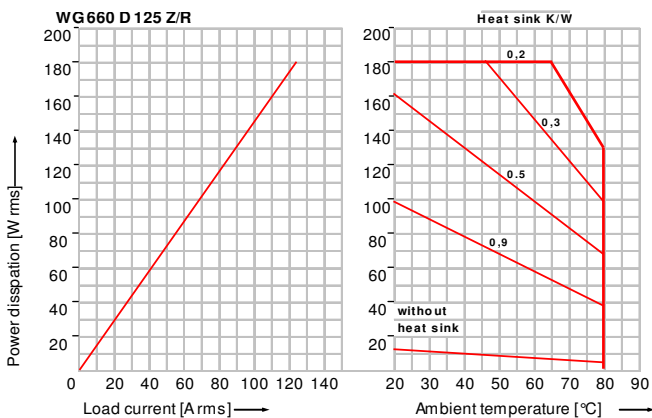

Number of SSR per heatsink/
load current per SSR

Heat sink	1 SSR	2 SSR
WG K1/100	13 A	8 A
WG K2/100	21 A	12 A
WG K3/160	58 A	33 A
WG K4/160L	125 A	85 A
WG K5/80	34 A	

Values for 40°C enclosure-temperature and mounted with Conduction paste between the SSR and the heat sink

Ordering

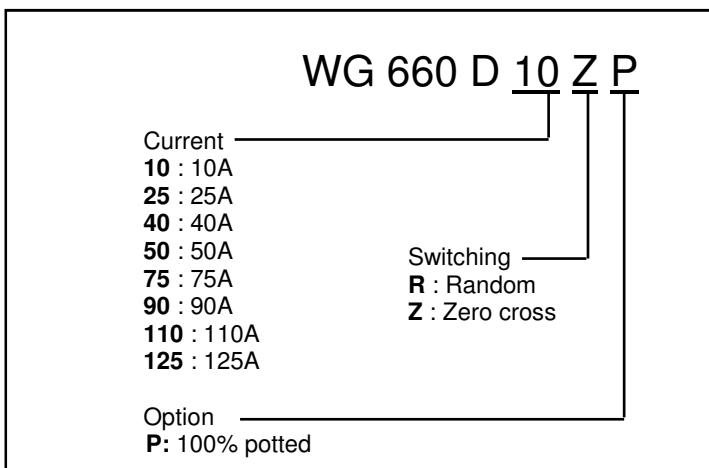

Description	Part Number
Protective case small	8440 5700 110
Thermal conducting paste	8406 0180 020
Heat sink WG K1/100	5981 5701 100
Heat sink WG K2/100	5981 5701 110
Heat sink WG K3/160	5981 5701 370
Heat sink WG K4/160L	5981 5701 371
Heat sink WG K5/80	5981 5701 372
Mounting plate DIN rail	5981 5701 430