

SR1 Series Single-Phase, Detachable Heatsink Type SSR

Single-Phase, Detachable Heatsink Type SSR

■ Features

- Dielectric strength: 4000 VAC (also 2,500VAC model)
- Compact, universal design for flexible installation
- High heat dissipation efficiency with ceramic PCB
- Zero cross turn-on, random turn-on models available
- Zero cross turn-on, random turn-on models available
- Input Indicator (green LED)



! Please read "Safety considerations" in operation manual before using.



■ Ordering Information

SR	1	-	1	2	25		-	N
Item	Control phase		Rated input voltage	Rated load voltage	Rated load current (resistive load)	Function	Version	
							N	New
							No Mark	Zero cross turn-on
							R	Random turn-on
							15	15A
							25	25A
							40	40A
							50	50A
							75	75A
							2	24-240VAC
							4	48-480VAC
							1	4-30VDC
							4	90-240VAC
							1	Single-phase
							SR	Solid State Relay (detachable heatsink type)

Model	Rated input voltage	Rated load voltage	Rated input current	Function
SR1-1215-N	4-30VDC	15A	24-240VAC	Zero cross turn-on
SR1-4215-N	90-240VAC			
SR1-1225-N	4-30VDC	25A		
SR1-4225-N	90-240VAC			
SR1-1240-N	4-30VDC	40A		
SR1-4240-N	90-240VAC			
SR1-1250	4-30VDC	50A		
SR1-4250	90-240VAC			
SR1-1275	4-30VDC	75A		
SR1-4275	90-240VAC			
SR1-1415	4-30VDC	15A	48-480VAC	Zero cross turn-on
SR1-1415R	4-30VDC			Random turn-on
SR1-4415	90-240VAC	Zero cross turn-on		
SR1-1425	4-30VDC	25A		Zero cross turn-on
SR1-1425R	4-30VDC			Random turn-on
SR1-4425	90-240VAC	Zero cross turn-on		
SR1-1440	4-30VDC	40A		Zero cross turn-on
SR1-1440R	4-30VDC			Random turn-on
SR1-4440	90-240VAC	Zero cross turn-on		
SR1-1450	4-30VDC	50A		Zero cross turn-on
SR1-1450R	4-30VDC		Random turn-on	
SR1-4450	90-240VAC	Zero cross turn-on		
SR1-1475	4-30VDC	75A	Zero cross turn-on	
SR1-1475R	4-30VDC		Random turn-on	
SR1-4475	90-240VAC	Zero cross turn-on		

- (A) Photoelectric Sensors
- (B) Fiber Optic Sensors
- (C) Door/Area Sensors
- (D) Proximity Sensors
- (E) Pressure Sensors
- (F) Rotary Encoders
- (G) Connectors/ Connector Cables/ Sensor Distribution Boxes/Sockets
- (H) Temperature Controllers
- (I) SSRs / Power Controllers
- (J) Counters
- (K) Timers
- (L) Panel Meters
- (M) Tacho / Speed / Pulse Meters
- (N) Display Units
- (O) Sensor Controllers
- (P) Switching Mode Power Supplies
- (Q) Stepper Motors & Drivers & Controllers
- (R) Graphic/ Logic Panels
- (S) Field Network Devices
- (T) Software

SR1 Series

■ Specifications

◎ Input

● SR1-□□□□-N

Rated input voltage range	4-30VDC [※]	90-240VACrms~ (50/60Hz)
Allowable input voltage range	4-32VDC [※]	85-264VACrms~ (50/60Hz)
Max. input current	18mA	18mArms (240VACrms~)
Pick-up voltage	Min. 4VDC [※]	Min. 85VACrms~
Drop-out voltage	Max. 1VDC [※]	Max. 10VACrms~
Turn-on time	Zero cross turn-on	Max. 0.5 cycle of load source + 1ms
		Max. 2 cycle of load source + 1ms
Turn-off time		Max. 0.5 cycle of load source + 1ms
		Max. 2 cycle of load source + 1ms

● SR1-□□□□

Rated input voltage range	4-30VDC [※]	90-240VACrms~ (50/60Hz)
Allowable input voltage range	4-32VDC [※]	85-264VACrms~ (50/60Hz)
Max. input current	9mA (Zero cross turn-on), 13mA (Random turn-on)	7mArms (240VACrms~)
Pick-up voltage	Min. 4VDC [※]	Min. 85VACrms~
Drop-out voltage	Max. 1VDC [※]	Max. 10VACrms~
Turn-on time	Zero cross turn-on	Max. 0.5 cycle of load source + 1ms
	Random turn-on	Max. 1ms
Turn-off time		Max. 0.5 cycle of load source + 1ms
		Max. 1.5 cycle of load source + 1ms

◎ Output

Rated load voltage range	24-240VACrms~ (50/60Hz)					48-480VACrms~ (50/60Hz)					
Allowable load voltage range	24-264VACrms~ (50/60Hz)					48-528VACrms~ (50/60Hz)					
Rated load current	Resistive load (AC-51) ^{※1}	15Arms	25Arms	40Arms	50Arms	75Arms	15Arms	25Arms	40Arms	50Arms	75Arms
Min. load current		0.15Arms	0.2Arms	0.5Arms	0.5Arms	0.5Arms	0.5Arms	0.5Arms	0.5Arms	0.5Arms	0.5Arms
Max. 1 cycle surge current (60Hz)		160A	250A	400A	1000A	1000A	300A	500A	500A	1000A	1000A
Max. non-repetitive surge current (I ² t, t=8.3ms)		130A ² s	300A ² s	910A ² s	4000A ² s	4000A ² s	350A ² s	1000A ² s	1000A ² s	4000A ² s	4000A ² s
Peak voltage (Non-repetitive)		600V					1200V (Zero cross turn-on), 1000V (Random turn-on)				
Leakage current (Ta=25°C)		Max. 10mArms (240VAC~/60Hz)					Max. 10mArms (480VAC~/60Hz)				
Output on voltage drop[Vpk] (Max. load current)		Max. 1.6V					Max. 1.6V				
Static off state dv/dt		500V/μs					500V/μs				

※1: AC-51 is utilization category at IEC60947-4-3.

◎ General Specifications

Dielectric strength (Vrms)	<ul style="list-style-type: none"> SR1-□□□□-N: 2500VAC~ 50/60Hz 1 min (Input-Output, Input/Output-Case) SR1-□□□□: 4000VAC~ 50/60Hz 1 min (Input-Output, Input/Output-Case) 	
Insulation resistance	Over 100MΩ (at 500VDC megger) (Input-Output, Input/Output-Case)	
Indicator	Input indicator: Green LED	
Vibration	Mechanical	0.75mm amplitude at frequency of 10 to 55Hz (for 1 min) in each X, Y, Z direction for 1 hour
	Malfuction	0.5mm amplitude at frequency of 10 to 55Hz (for 1 min) in each X, Y, Z direction for 10 min
Shock	Mechanical	300m/s ² (approx. 30G) in each X, Y, Z direction for 3 times
	Malfuction	100m/s ² (approx. 30G) in each X, Y, Z direction for 3 times
Environment	Ambient temp.	-30 to 80°C (in case of the rated input voltage 90-240VAC~: -20 to 70°C), storage: -30 to 100°C (The rated load current capacity is different depending on ambient temperature. Refer to 1■ SSR Derating Curve'.)
	Ambient humi.	45 to 85%RH, storage: 45 to 85%RH
Input terminal connection	Min. 1×0.5mm ² (1×AWG20), Max. 1×1.5mm ² (1×AWG16) or 2×1.5mm ² (2×AWG16)	
Output terminal connection	Min. 1×1.5mm ² (1×AWG16), Max. 1×16mm ² (1×AWG6) or 2×6mm ² (2×AWG10)	
Input terminal fixed torque	0.75 to 0.95N·m	
Output terminal fixed torque	1.6 to 2.2N·m	
Approval	CE c  us (except SR1-□□□□-N)	
Weight ^{※1}	Approx. 111g (approx. 73g)	

※1: The weight includes packaging. The weight in parenthesis is for unit only.

※Environment resistance is rated at no freezing or condensation.

※For wiring the terminal, an O-ring terminal must be used.

Single-Phase, Detachable Heatsink Type SSR

■ SSR Derating Curve

※ Be sure that the ambient temperature and the derating curve is different by the rated input voltage.

- : Rated input voltage 4-30VDC (SR1-1□□□□)
- : Rated input voltage 90-240VAC (SR1-4□□□□)

◎ SR1-1215-N SR1-4215-N

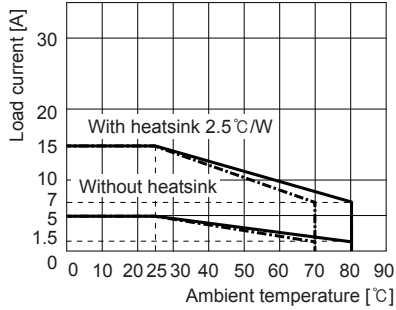

◎ SR1-1415/1415R SR1-4415

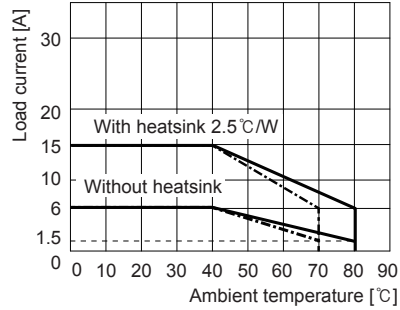

◎ SR1-1225-N SR1-4225-N

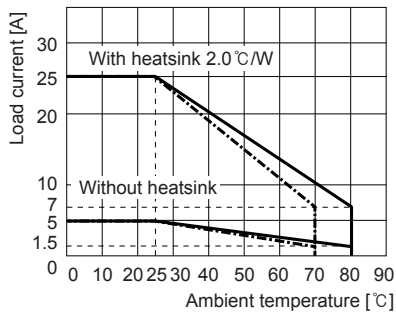

◎ SR1-1425/1425R SR1-4425

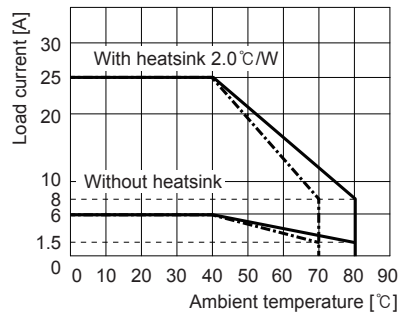

◎ SR1-1240-N SR1-4240-N

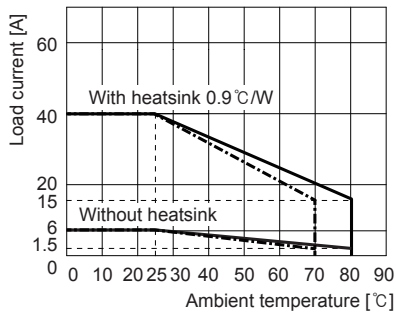

◎ SR1-1440/1440R SR1-4440

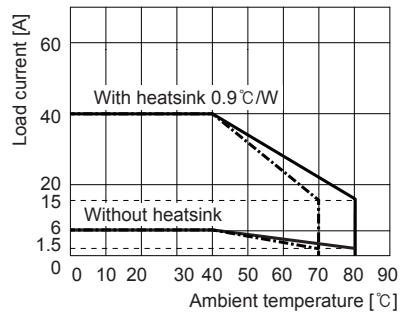

◎ SR1-1250/1450/1450R SR1-4250/4450

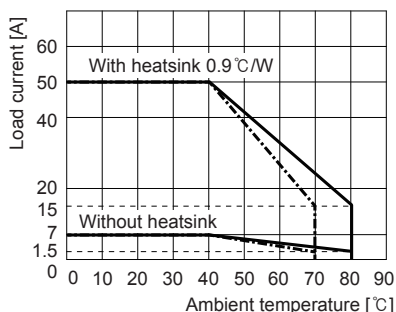

◎ SR1-1275/1475/1475R SR1-4275/4475

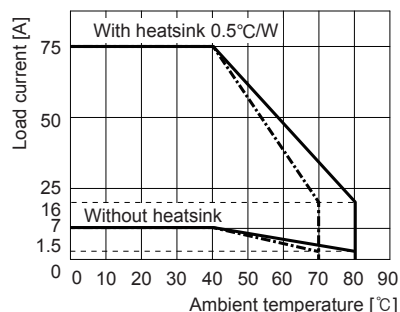

⚠ Please supply less than 50% of the rated load current when installing several SSRs closely due to decreasing effectiveness of protection against heat.

(A)	Photoelectric Sensors
(B)	Fiber Optic Sensors
(C)	Door/Area Sensors
(D)	Proximity Sensors
(E)	Pressure Sensors
(F)	Rotary Encoders
(G)	Connectors/ Connector Cables/ Sensor Distribution Boxes/Sockets
(H)	Temperature Controllers
(I)	SSRs / Power Controllers
(J)	Counters
(K)	Timers
(L)	Panel Meters
(M)	Tacho / Speed / Pulse Meters
(N)	Display Units
(O)	Sensor Controllers
(P)	Switching Mode Power Supplies
(Q)	Stepper Motors & Drivers & Controllers
(R)	Graphic/ Logic Panels
(S)	Field Network Devices
(T)	Software

SR1 Series

■ Dimensions

(unit: mm)

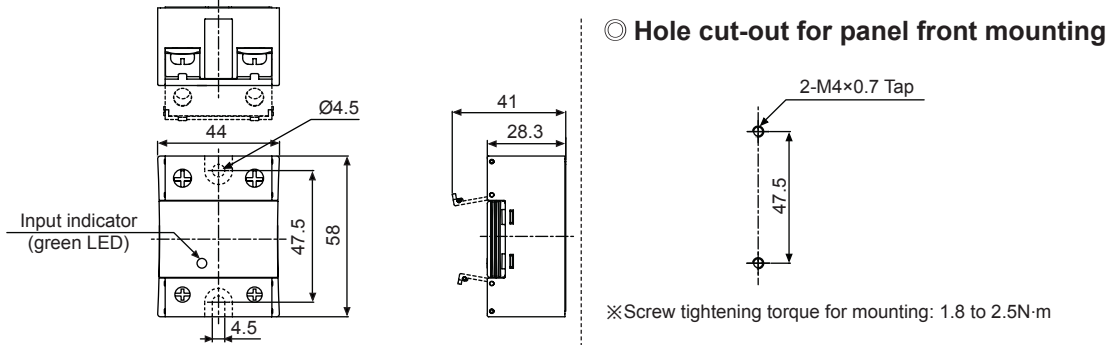

■ Connections

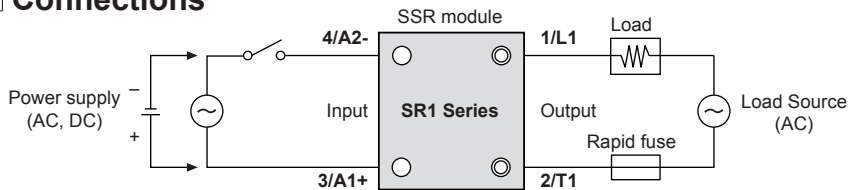

■ Proper Usage



High temperature caution

Make sure do not touch the heat sink or the unit body while power is supplied or right after load power is turned off. If not, it may cause a burn.



Cautions during use

1. Attach a heatsink and ventilate for smooth convection current. If not, congested heat transfer may cause product failure or malfunction.
2. For mounting multiple SSR, please keep certain installation intervals for heat prevention. For horizontal installation (when the heights of input part and output part are equal), it is recommended to apply less than 50% of the rated load current.
3. Make sure do not touch the heatsink or the unit body while power is supplied or right after load power is turned OFF. If not, it may cause a burn.
4. Connect the proper cable for the rated load current with output terminal.
5. Use rapid fuse of which I^2t is under 1/2 of SSR I^2t in order to protect the unit from load's short-circuit current. In case of a short-circuit please replace the fuse which has same specification.
6. In case that load's current is lower than SSR min. load current, connect dummy resistance to the load in parallel so as to make load's current higher than SSR min. load current.
7. When selecting phase control with random turn-on model, install the noise filter between load and load's source.
8. Make sure that the screw on output terminal is tightly fastened. Using the unit with loose bolt may cause product failure or malfunction.
9. Do not touch the load's terminal even if output is OFF. It may cause electric shock.
10. In case of 4-30VDC model, the signal input should be insulated and limited voltage/current or Class 2, SELV power supply device.
11. To attach the heatsink, use Thermal Grease as below or that of equal specification.
 ※Thermal Grease: GE TOSHIBA (YG6111), KANTO-KASEI (FLOIL G-600), SHINETSU (G746)
12. Avoid following environments to install this unit.
 - ① Where temperature/humidity is beyond the specification
 - ② Where dew condensation occurs due to temperature change
 - ③ Where inflammable or corrosive gas exists
 - ④ Where direct rays of light exist
 - ⑤ Where severe shock, vibration or dust exists
 - ⑥ Where near facilities generating strong magnetic forces or electric noise
13. This product may be used in the following environments.
 - ① Indoors
 - ② Max. altitude: 2,000m
 - ③ Pollution degree 2
 - ④ Installation category III