

77 Series - Modular Solid State Relay 5 A
Features
5 A modular SSR, 1 NO output

- 17.5 mm housing
- 60 to 240 V AC output (with back to back SCR)
- 5 kV (1.2/50 μ s) insulation between Input and Output
- Zero-crossing and random switch-on versions available
- High switching speed
- High endurance
- Silent switching
- Spark and bounce-free switching
- Low control power
- 35 mm rail (EN 60715) mount

77.01

Screw terminal



* See L77-3 diagram page 10

** See L77-1 and L77-2 diagrams page 9

For outline drawing see page 12

Output specification

Output configuration	1 NO (SPST-NO)		1 NO (SPST-NO)		
Rated current I_N /Max. peak current* (10 ms)	A	5/300*	5/300*	5/300*	
Rated voltage	V AC (50/60 Hz)	230	230	230	
Rated voltage range	V AC (50/60 Hz)	60...240	60...240	60...240	
Switching voltage range	V AC (50/60 Hz)	48...265	48...265	48...265	
Repetitive peak off-state voltage	V_{pk}	800	800	800	
Rated load AC7a (cos $\varphi = 0.8$)	A	5	5	5	
Rated load AC15	A	5	3	3	
Single phase motor rating (230 V AC)	kW	—	—	0.37	
Nominal lamp rating:					
230 V incandescent/halogen W		1000		800	
fluorescent tubes with electronic ballast W		1000		800	
fluorescent tubes with electromechanical ballast W		1000		800	
CFL W		800		400	
230 V LED W		800		400	
LV halogen or LED with electronic ballast W		800		400	
LV halogen or LED with electromechanical ballast W		1000		800	
Minimum switching current @ 230 V	mA	100		100	
Typical "OFF-state" leakage current @ 230 V	mA	1		1	
Max "ON-state" voltage drop @ 25 °C and 5 A/100 mA	V	0.85/1.5		0.85/1.5	
Power loss @ 5 A	W	4		4	
Input specification					
Nominal voltage (U_N)	V AC (50/60 Hz)	24	230	24	230
	V DC	12...24	—	12...24	—
Rated power	VA (50 Hz)/W	0.6/0.5	3.6/0.3	0.6/0.5	3.6/0.3
Operating range	V AC (50/60 Hz)	16...32	90...265	16...32	90...265
	V DC	9.8...32	—	9.8...32	—
Must drop-out voltage	V AC (50/60 Hz)/DC	2.4	24	2.4	24
Technical data					
Electrical life	cycles	$10 \cdot 10^6$		$10 \cdot 10^6$	
Operate/release time	ms	20/12		9/8	
Insulation between input and output (1.2/50 μ s)	kV	5		5	
Ambient temperature	°C	-20...+70**		-20...+70**	
Protection category		IP 20		IP 20	

Approvals (according to type)

77.01.x.xxx.8050

Zero-crossing switch-on Suggested applications:

- Lamp inrush current reduction (CFL - Compact Fluorescent energy-saving Lamps and similar)
- Heater control
- Solenoid, contactor driver

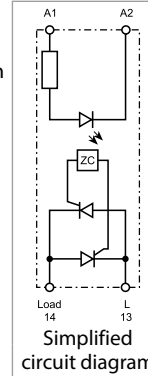
77.01.x.xxx.8051

Random switch-on Suggested applications:

- Finer control requiring short operate time (specially motor control)
- AC Input phase different from AC Output phase
- 3-phase general purpose

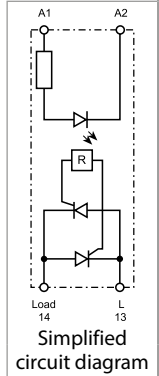

Features

15 A modular SSR, 1 NO output

- 22.5 mm housing, heat-sink + plastic cover
- 24 to 277 V AC output (with triac)
- 6 kV (1.2/50 µs) insulation between Input and Output
- Zero-crossing and random switch-on versions available
- High switching speed
- High endurance
- Silent switching
- Spark and bounce-free switching
- Low control power
- "Relay-style" terminal arrangement (input and output terminals on opposite sides)
- 35 mm rail (EN 60715) mount

77.11
Screw terminal



* See L77-7 diagram page 10
** See L77-6 diagrams page 9

For outline drawing see page 12

Output specification

Output configuration	1 NO (SPST-NO)		1 NO (SPST-NO)	
Rated current I _N /Max. peak current* (10 ms) A	5/400*		15/400*	
Rated voltage V AC (50/60 Hz)	230		230	
Rated voltage range V AC (50/60 Hz)	24...277		24...277	
Switching voltage range V AC (50/60 Hz)	48...265		19...305	
Repetitive peak off-state voltage V _{pk}	800		800	
Rated load AC7a (cos φ = 0.8, @ 25 °C) A	20		20	
Rated load AC15 A	15		15	
Single phase motor rating (230 V AC) kW	—		1.2	
Nominal lamp rating:				
230 V incandescent/halogen W	4000		2500	
fluorescent tubes with electronic ballast W	4000		2500	
fluorescent tubes with electromechanical ballast W	2000		1000	
CFL W	3000		1500	
230 V LED W	3000		1500	
LV halogen or LED with electronic ballast W	3000		1500	
LV halogen or LED with electromechanical ballast W	3000		1500	
Minimum switching current @ 250 V mA	100		100	
Typical "OFF-state" leakage current @ 250 V mA	1		1	
Max "ON-state" voltage drop @ 25 °C and 15 A V	1.55		1.55	
Power loss @ 15 A W	14		14	

Input specification

Nominal voltage (U _N)	V AC (50/60 Hz)	—	230	—	230
	V DC	24	—	24	—
Rated power	VA (50 Hz)/W	0.4	7.5/0.9	0.4	7.5/0.9
Operating range	V AC (50/60 Hz)	—	40...305	—	40...305
	V DC	4...32	—	4...32	—
Must drop-out voltage	V AC (50/60 Hz)/DC	—/2	6/—	—/2	6/—

Technical data

Electrical life	cycles	10 · 10 ⁶		10 · 10 ⁶	
Operate/release time	ms	< 10/< 10	< 10/< 30	< 1/< 10	< 2/< 25
Insulation between input and output (1.2/50 µs)	kV	6		6	
Ambient temperature	°C	-20...+80**		-20...+80**	
Protection category		IP 20		IP 20	

Approvals (according to type)



77.11.x.xxx.8250



Zero-crossing switch-on

Suggested applications:

- Lamp inrush current reduction (CFL - Compact Fluorescent energy-saving Lamps and similar)
- Heater control
- Solenoid, contactor driver

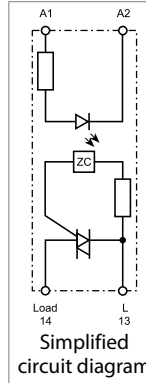

77.11.x.xxx.8251



Random switch-on

Suggested applications:

- Fine controls involving shorter time (specially motor control)

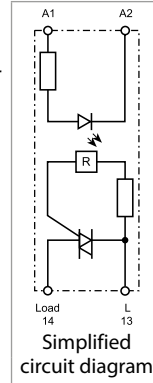

Features

30 A modular SSR, 1 NO output

- 22.5 mm housing, heat-sink + plastic cover
- 60 to 440 V AC output (with back to back SCR)
- 6 kV (1.2/50 µs) insulation between Input and Output
- Zero-crossing and random switch-on versions available
- High switching speed
- High endurance
- Silent switching
- Spark and bounce-free switching
- Low control power
- "Relay-style" terminal arrangement (input and output terminals on opposite sides)
- 35 mm rail (EN 60715) mount

77.31
Screw terminal



* See L77-5 diagram page 10
** See L77-4 diagrams page 9

For outline drawing see page 12

Output specification

Output configuration	1 NO (SPST-NO)		1 NO (SPST-NO)	
Rated current I _N /Max. peak current* (10 ms) A	30/520*		30/520*	
Rated voltage V AC (50/60 Hz)	400		400	
Rated voltage range V AC (50/60 Hz)	60...440		60...440	
Switching voltage range V AC (50/60 Hz)	48...480		48...480	
Repetitive peak off-state voltage V _{pk}	1100		1100	
Rated load AC7a (cos φ = 0.8) A	30		30	
Rated load AC15 A	20		20	
Single phase motor rating (230 V AC) kW	—		2.5	
Nominal lamp rating:				
230 V incandescent/halogen W	6000		4500	
fluorescent tubes with electronic ballast W	6000		4000	
fluorescent tubes with electromechanical ballast W	3000		1800	
CFL W	4000		2500	
230 V LED W	4000		2500	
LV halogen or LED with electronic ballast W	4000		2500	
LV halogen or LED with electromechanical ballast W	4000		2500	
Minimum switching current @ 400 V mA	300		300	
Typical "OFF-state" leakage current @ 400 V mA	1		1	
Max "ON-state" voltage drop @ 25 °C and 30 A V	0.85		0.85	
Power loss @ 30 A W	16		16	

Input specification

Nominal voltage (U _N)	V AC (50/60 Hz)	—	230	—	230
	V DC	24	—	24	—
Rated power @ U _{MAX}	VA (50 Hz)/W	0.4	7.5/0.9	0.4	7.5/0.9
Operating range	V AC (50/60 Hz)	—	40...280	—	40...280
	V DC	4...32	—	4...32	—
Must drop-out voltage	V AC (50/60 Hz)/DC	—/2	6/—	—/2	6/—

Technical data

Electrical life	cycles	10 · 10 ⁶		10 · 10 ⁶	
Operate/release time	ms	< 10/< 10	< 10/< 30	< 1/< 10	< 2/< 25
Insulation between input and output (1.2/50 µs)	kV	6		6	
Ambient temperature	°C	-20...+80**		-20...+80**	
Protection category		IP 20		IP 20	

Approvals (according to type)



77.31.x.xxx.8050



Zero-crossing switch-on Suggested applications:

- Lamp inrush current reduction (CFL - Compact Fluorescent energy-saving Lamps and similar)
- Heater control
- Solenoid, contactor driver

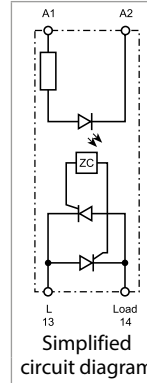

77.31.x.xxx.8051



Random switch-on Suggested applications:

- Finer control requiring short operate time (specially motor control)

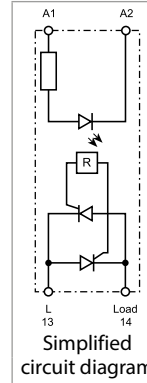

77 Series - Modular Solid State Relay 30 A

Features

30 A modular SSR, 1 NO output

- 22.5 mm housing, heat-sink + plastic cover
- 60 to 440V AC output (with back to back SCR)
- 6 kV (1.2/50 μs) insulation between Input and Output
- Zero-crossing and random switch-on versions available
- High switching speed
- High endurance
- Silent switching
- Spark and bounce-free switching
- Low control power
- "Contactor-style" terminal arrangement (input and output terminals on adjacent sides)
- 35 mm rail (EN 60715) mount

77.31
Screw terminal



* See L77-5 diagram page 10

** See L77-4 diagrams page 9

For outline drawing see page 12

Output specification

Output configuration	1 NO (SPST-NO)		1 NO (SPST-NO)	
Rated current I_N /Max. peak current* (10 ms) A	30/520*		30/520*	
Rated voltage V AC (50/60 Hz)	400		400	
Rated voltage range V AC (50/60 Hz)	60...440		60...440	
Switching voltage range V AC (50/60 Hz)	48...480		48...480	
Repetitive peak off-state voltage V_{pk}	1100		1100	
Rated load AC7a (cos φ = 0.8) A	30		30	
Rated load AC15 A	20		20	
Single phase motor rating (230 V AC) kW	—		2.5	
Nominal lamp rating:				
230 V incandescent/halogen W	6000		4500	
fluorescent tubes with electronic ballast W	6000		4000	
fluorescent tubes with electromechanical ballast W	3000		1800	
CFL W	4000		2500	
230 V LED W	4000		2500	
LV halogen or LED with electronic ballast W	4000		2500	
LV halogen or LED with electromechanical ballast W	4000		2500	
Minimum switching current @ 400 V mA	300		300	
Typical "OFF-state" leakage current @ 400 V mA	1		1	
Max "ON-state" voltage drop @ 25 °C and 30 A V	0.85		0.85	
Power loss @ 30 A W	16		16	

Input specification

Nominal voltage (U_N)	V AC (50/60 Hz)	—	230	—	230
	V DC	24	—	24	—
Rated power	VA (50 Hz)/W	0.4	7.5/0.9	0.4	7.5/0.9
Operating range	V AC (50/60 Hz)	—	40...280	—	40...280
	V DC	4...32	—	4...32	—
Must drop-out voltage	V AC (50/60 Hz)/DC	—/2	6/—	—/2	6/—

Technical data

Electrical life	cycles	10 · 10 ⁶		10 · 10 ⁶	
Operate/release time	ms	< 10/< 10	< 10/< 30	< 1/< 10	< 2/< 25
Insulation between input and output (1.2/50 μs)	kV	6		6	
Ambient temperature	°C	-20...+80**		-20...+80**	
Protection category		IP 20		IP 20	

Approvals (according to type)



77.31.x.xxx.8070



Zero-crossing switch-on

Suggested applications:

- Lamp inrush current reduction (CFL - Compact Fluorescent energy-saving Lamps and similar)
- Heater control
- Solenoid, contactor driver

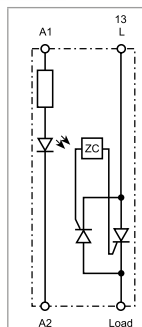

Simplified circuit diagram

77.31.x.xxx.8071



Random switch-on

Suggested applications:

- Fine controls involving shorter time (specially motor control)

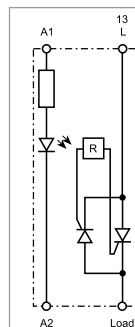

Simplified circuit diagram

77 Series - Hockey puck Solid State Relay, 25 - 40 - 50 A

Features

25, 40 And 50 A panel SSR, "hockey puck" style

- "hockey puck" housing with cover
- 24 to 240 V AC output
- Zero-crossing version
- High switching speed
- High endurance
- Silent switching
- Spark and bounce-free switching
- Low control power
- "Relay-style" terminal arrangement (input and output terminals on opposite sides)
- Mounting on heatsink with screws

77.x5
Screw terminal (plate clamp)



* See L77-11 diagrams page 10
** See L77-8, L77-9 and L77-10 diagrams page 9

For outline drawing see page 12

Output specification

Output configuration	1 NO (SPST-NO)		1 NO (SPST-NO)		1 NO (SPST-NO)	
Rated current I_N /Max. peak current* (10 ms) A	25/300*		40/500*		50/520*	
Rated voltage V AC (50/60 Hz)	230		230		230	
Rated voltage range V AC (50/60 Hz)	24...240		24...240		24...240	
Switching voltage range V AC (50/60 Hz)	21.6...280		21.6...280		21.6...280	
Repetitive peak off-state voltage V_{pk}	600		600		600	
Nominal lamp rating:						
230 V incandescent/halogen W	2000		4000		6000	
fluorescent tubes with electronic ballast W	2000		4000		6000	
fluorescent tubes with electromechanical ballast W	1000		2000		3000	
CFL W	800		3000		4000	
230 V LED W	800		3000		4000	
LV halogen or LED with electronic ballast W	800		3000		4000	
LV halogen or LED with electromechanical ballast W	1000		3000		4000	
Minimum switching current @ 250 V mA	120		250		250	
Typical "OFF-state" leakage current @ 250 V mA	10		10		10	
Max "ON-state" voltage drop @ 25 °C and I_N V	1.6		1.6		1.6	
Power loss @ I_N W	40		64		80	

Input specification

Nominal voltage (U_N)	V AC (50/60 Hz)	—	230	—	230	—	230
	V DC	24	—	24	—	24	—
Rated power @ U_{MAX}	VA (50 Hz)/W	—/0.6	2.4/—	—/0.6	2.4/—	—/0.6	2.4/—
Operating range	V AC (50/60 Hz)	—	90...280	—	90...280	—	90...280
	V DC	3...32	—	3...32	—	3...32	—
Must drop-out voltage	V AC (50/60 Hz)/DC	—/1	10/—	—/1	10/—	—/1	10/—

Technical data

Electrical life	cycles	10 · 10 ⁶		10 · 10 ⁶		10 · 10 ⁶	
Operate/release time	ms	10/10	40/80	10/10	40/80	10/10	40/80
Insulation between input and output (1.2/50 μs)	kV	5.6		5.6		5.6	
Ambient temperature	°C	-30...+80**		-30...+80**		-30...+80**	
Protection category		IP 20		IP 20		IP 20	

Approvals (according to type)



NEW 77.25.x.xxx.8250



Zero-crossing switch-on

- Output: 25 A/230 V AC
- Suggested applications: heater control

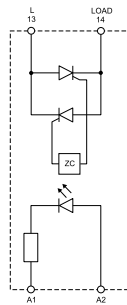

Simplified circuit diagram

NEW 77.45.x.xxx.8250



Zero-crossing switch-on

- Output: 40 A/230 V AC
- Suggested applications: heater control

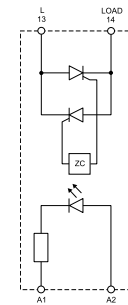

Simplified circuit diagram

NEW 77.55.x.xxx.8250



Zero-crossing switch-on

- Output: 25 A/230 V AC
- Suggested applications: heater control

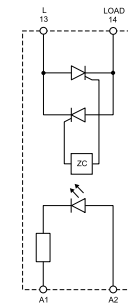

Simplified circuit diagram

77 Series - Hockey puck Solid State Relay, 25 - 40 - 50 A

Features

25, 40 And 50 A panel SSR, "hockey puck" style

- "hockey puck" housing with cover
- 48 to 600 V AC output
- Zero-crossing version
- High switching speed
- High endurance
- Silent switching
- Spark and bounce-free switching
- Low control power
- "Relay-style" terminal arrangement (input and output terminals on opposite sides)
- Mounting on heatsink with screws

77.x5
Screw terminal (plate clamp)



* See L77-11 diagrams page 10
** See L77-8, L77-9 and L77-10 diagrams page 9

For outline drawing see page 12

Output specification

Output configuration	1 NO (SPST-NO)	1 NO (SPST-NO)	1 NO (SPST-NO)
Rated current I_N /Max. peak current* (10 ms) A	25/300*	40/500*	50/520*
Rated voltage V AC (50/60 Hz)	600	600	600
Rated voltage range V AC (50/60 Hz)	48...600	48...600	48...600
Switching voltage range V AC (50/60 Hz)	43.2...660	43.2...660	43.2...660
Repetitive peak off-state voltage V_{pk}	1200	1200	1200
Nominal lamp rating:			
230 V incandescent/halogen W	2000	4000	6000
fluorescent tubes with electronic ballast W	2000	4000	6000
fluorescent tubes with electromechanical ballast W	1000	2000	3000
CFL W	800	3000	4000
230 V LED W	800	3000	4000
LV halogen or LED with electronic ballast W	800	3000	4000
LV halogen or LED with electromechanical ballast W	1000	3000	4000
Minimum switching current @ 250 V mA	120	250	250
Typical "OFF-state" leakage current @ 250 V mA	10	10	10
Max "ON-state" voltage drop @ 25 °C and I_N V	1.6	1.6	1.6
Power loss @ I_N W	40	64	80

Input specification

Nominal voltage (U_N)	V AC (50/60 Hz)	—	230	—	230	—	230
	V DC	24	—	24	—	24	—
Rated power @ U_{MAX}	VA (50 Hz)/W	—/0.6	2.4/—	—/0.6	2.4/—	—/0.6	2.4/—
Operating range	V AC (50/60 Hz)	—	90...280	—	90...280	—	90...280
	V DC	4...32	—	4...32	—	4...32	—
Must drop-out voltage	V AC (50/60 Hz)/DC	—/1	10/—	—/1	10/—	—/1	10/—

Technical data

Electrical life	cycles	10 · 10 ⁶		10 · 10 ⁶		10 · 10 ⁶	
Operate/release time	ms	10/10	40/80	10/10	40/80	10/10	40/80
Insulation between input and output (1.2/50 μs)	kV	5.6		5.6		5.6	
Ambient temperature	°C	-30...+80**		-30...+80**		-30...+80**	
Protection category		IP 20		IP 20		IP 20	

Approvals (according to type)



NEW 77.25.x.xxx.8650



Zero-crossing switch-on
• Output: 25 A/600 V AC
• Suggested applications: heater control

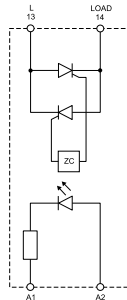

NEW 77.45.x.xxx.8650



Zero-crossing switch-on
• Output: 40 A/600 V AC
• Suggested applications: heater control

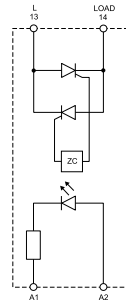

NEW 77.55.x.xxx.8650



Zero-crossing switch-on
• Output: 25 A/600 V AC
• Suggested applications: heater control

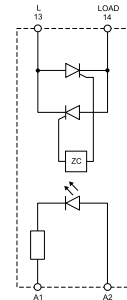

Input specification

77.01

Nominal voltage	Input code	Operating range				Must drop-out voltage (AC/DC)	Input current I_N at U_N
		AC		DC			
		U_{min}	U_{max}	U_{min}	U_{max}		
U_N		V	V	V	V	V	mA
24	0.024	16	32	9.8	32	2.4	25
230	8.230	90	265	—	—	24	15

77.11

Nominal voltage	Input code	Operating range				Must drop-out voltage (AC/DC)	Input current I_N at U_N
		AC		DC			
		U_{min}	U_{max}	U_{min}	U_{max}		
U_N		V	V	V	V	V	mA
4	9.024	—	—	4	32	2	11
230	8.230	40	305	—	—	6	25

77.31

Nominal voltage	Input code	Operating range				Must drop-out voltage (AC/DC)	Input current I_N at U_N
		AC		DC			
		U_{min}	U_{max}	U_{min}	U_{max}		
U_N		V	V	V	V	V	mA
24	9.024	—	—	4	32	2	11
230	8.230	40	280	—	—	6	25

77.x5.x.xxx.8250

Nominal voltage	Input code	Operating range				Must drop-out voltage (AC/DC)	Input current I_N at U_N
		AC		DC			
		U_{min}	U_{max}	U_{min}	U_{max}		
U_N		V	V	V	V	V	mA
24	9.024	—	—	3	32	1	22
230	8.230	90	280	—	—	10	20

77.x5.x.xxx.8650

Nominal voltage	Input code	Operating range				Must drop-out voltage (AC/DC)	Input current I_N at U_N
		AC		DC			
		U_{min}	U_{max}	U_{min}	U_{max}		
U_N		V	V	V	V	V	mA
24	9.024	—	—	4	32	1	25
230	8.230	90	280	—	—	10	10

Led indication

LED	Supply voltage
	OFF
	ON

D

Output specification

L77-1 Output RMS current v ambient temperature
77.01.0.024.805x @ 32 V DC

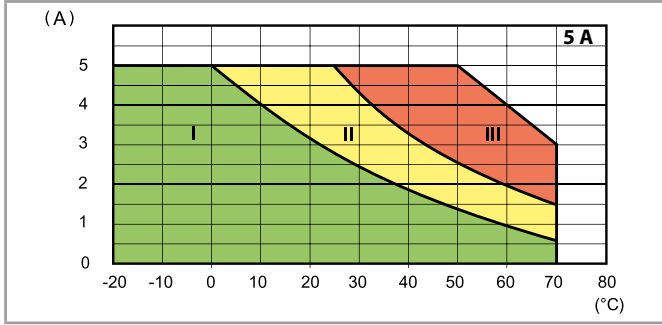

- I - Modular SSR installed as a group (without gap)
- II - Modular SSR installed as a group (9 mm gap between each SSR)
- III - Modular SSR installed individually in free air (without a significant influence from nearby components)

L77-2 Output RMS current v ambient temperature
77.01.8.230.805x @ 265 V AC

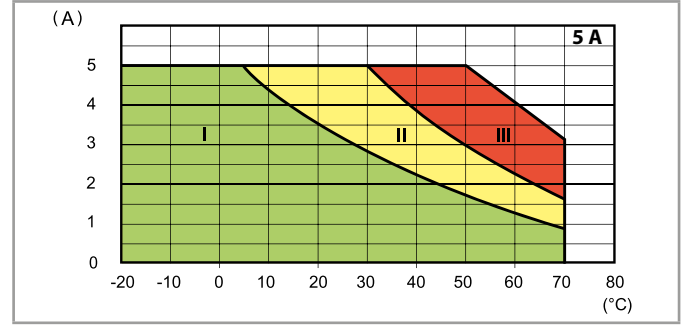

L77-6 Output RMS current v ambient temperature
77.11.x.xxx.82xx

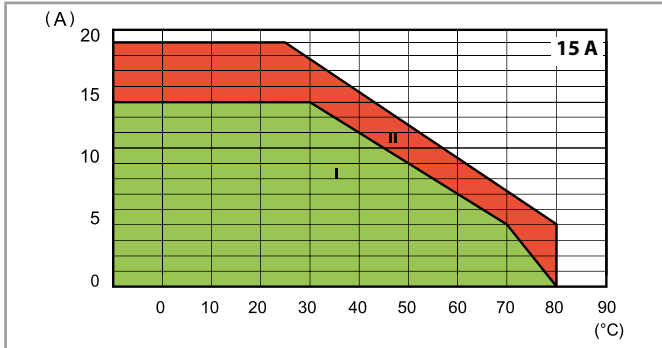

- I - Modular SSR installed as a group (without gap)
- II - Modular SSR installed individually in free air , or with a gap ≥ 20 mm, which implies a not significant influence from nearby components

L77-4 Output RMS current v ambient temperature
77.31.x.xxx.80xx

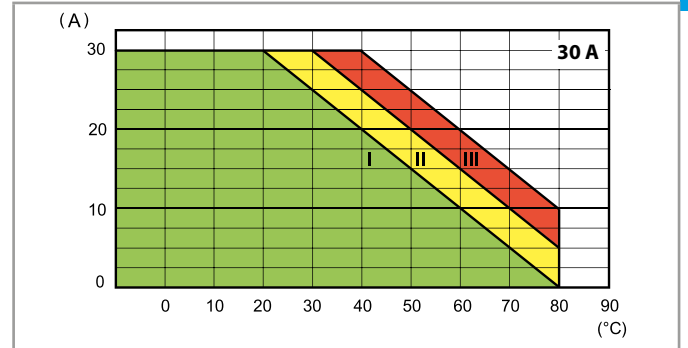

- I - Modular SSR installed as a group (without gap)
- II - Modular SSR installed as a group (20 mm gap between each SSR)
- III - Modular SSR installed individually in free air , or with a gap ≥ 40 mm, which implies a not significant influence from nearby components)

L77-10 Output RMS current v ambient temperature
77.25.x.xxx.8x50

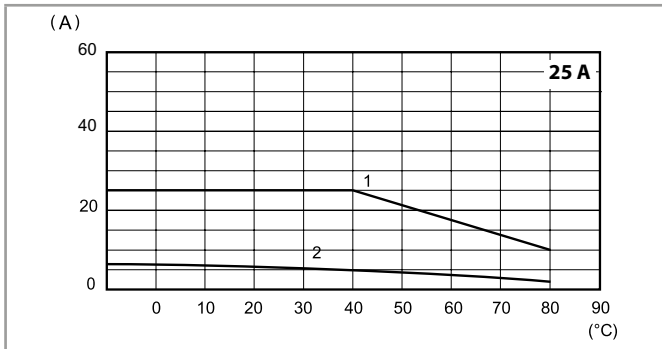

- 1 - Installation on 0.77.25 heat-sink (2 K/W)
- 2 - Installation individually in free-air

L77-9 Output RMS current v ambient temperature
77.45.x.xxx.8x50

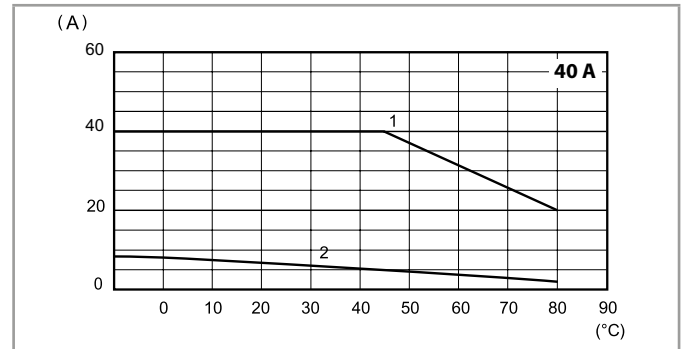

- 1 - Installation on 0.77.55 heat-sink (0.9 K/W)
- 2 - Installation individually in free-air

L77-8 Output RMS current v ambient temperature
77.55.x.xxx.8x50

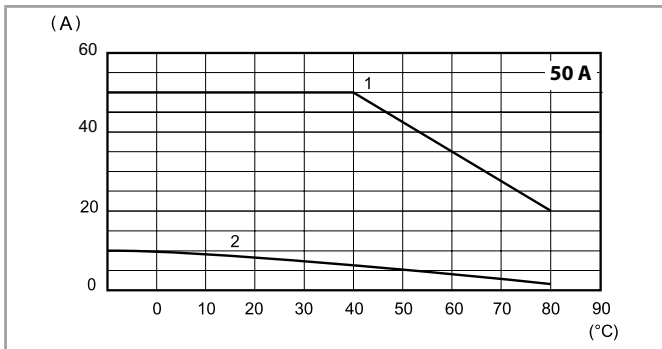

- 1 - Installation on 0.77.55 heat-sink (0.9 K/W)
- 2 - Installation individually in free-air

Output specification

L77-3 Inrush peak current (AC) v inrush time
77.01.x.xxx.80xx

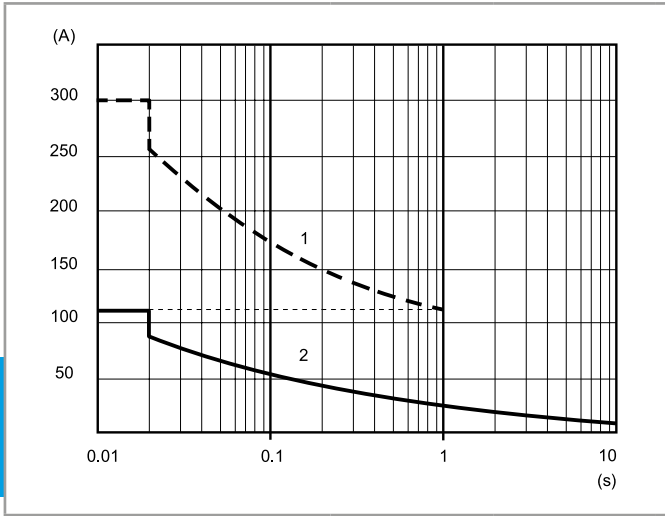

L77-7 Inrush peak current (AC) v inrush time
77.11.x.xxx.82xx

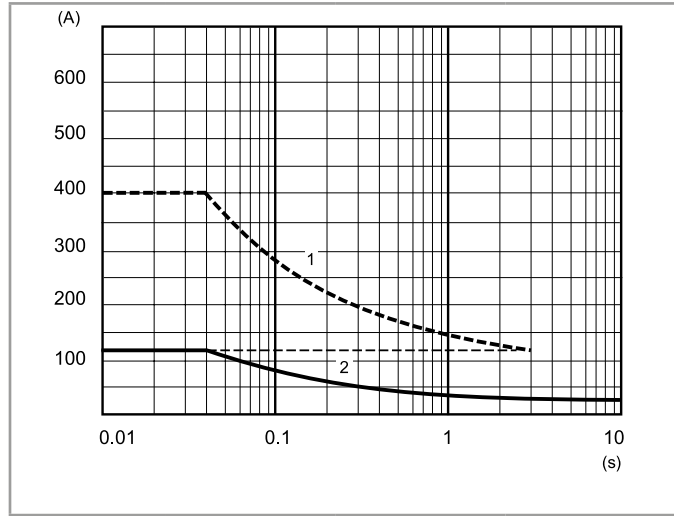

L77-5 Inrush peak current (AC) v inrush time
77.31.x.xxx.80xx

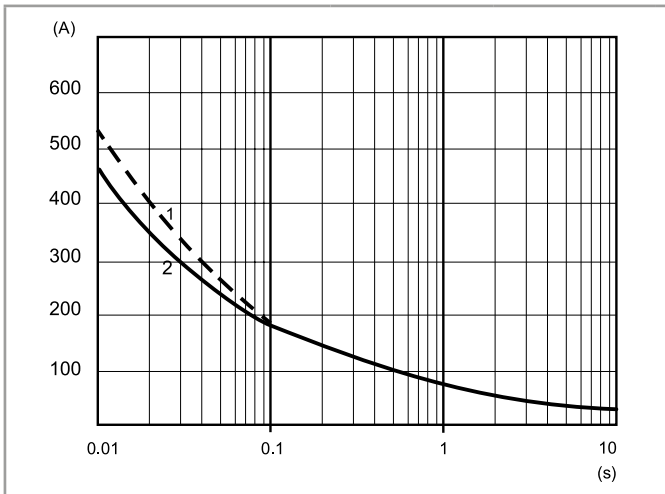

L77-11 Inrush peak current (AC) v inrush time
77x5.x.xxx.8x50

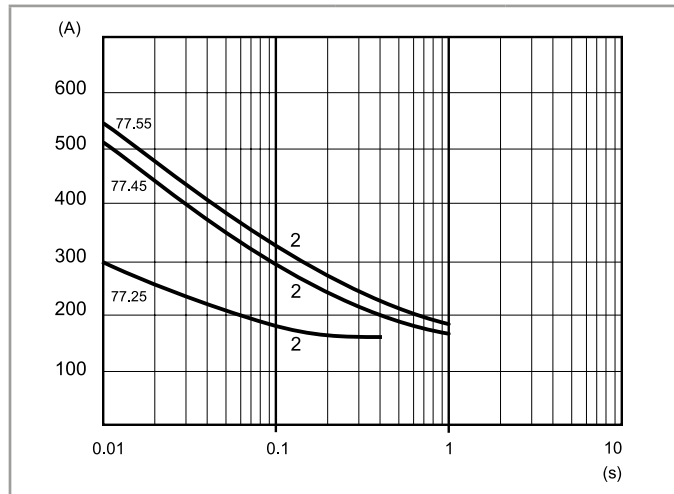

1 - "Cold" conditions (ambient temperature = 23 °C, no output current during the last 15 minutes)
2 - "Hot" conditions (ambient temperature = 50 °C, rated output current)

Max recommended switching frequency (Cycles/Hour, with 50% Duty-cycle)

Load	77.01	77.11	77.31	77.25	77.45	77.55
5 A 230 V (AC1)	5000	—	—	—	—	—
1 A (AC15)	10000	—	—	—	—	—
0.5 A (AC15)	20000	—	—	—	—	—
15 A 305 V cos φ = 0.8	—	1800	—	—	—	—
15 A 305 V cos φ = 0.5	—	1200	—	—	—	—
30 A 480 V cos φ = 0.8	—	—	1800	—	—	—
30 A 480 V cos φ = 0.5	—	—	1200	—	—	—
25 A 230 V cos φ = 0.7	—	—	—	1800	—	—
40 A 230 V cos φ = 0.7	—	—	—	—	1800	—
50 A 230 V cos φ = 0.7	—	—	—	—	—	1800

Other data

	77.01	77.11	77.31	77.25	77.45	77.55
Critical rising voltage dv/dt without input control (gate open) @ T _j = 125 °C	> 1000 V/μs	> 500 V/μs > 10 V/μs (with di/dt = 20 A/ms)	> 1000 V/μs	300 V/μs (.8250) 500 V/μs (.8650)	500 V/μs (.8250) 1000 V/μs (.8650)	1000 V/μs (.8250) 1000 V/μs (.8650)
Critical rising current di/dt @ T _j = 125 °C	> 50 A/μs	> 50 A/μs	> 150 A/μs	—	—	—
I²t for fusing @ t _p = 10 ms	450 A ² s	1000 A ² s*	1350 A ² s**	450 A ² s	1250 A ² s	1350 A ² s

Suggested fuse (depending on application) for short-circuit protection (Ultra-Fast acting types for semiconductors):

* 20 A, 660 V AC, 10 x 38 mm, 200 kA, 360 A²s.

** 30 A, 660 V AC, 10 x 38 mm, 200 kA, 1000 A²s.

D

Wiring diagrams

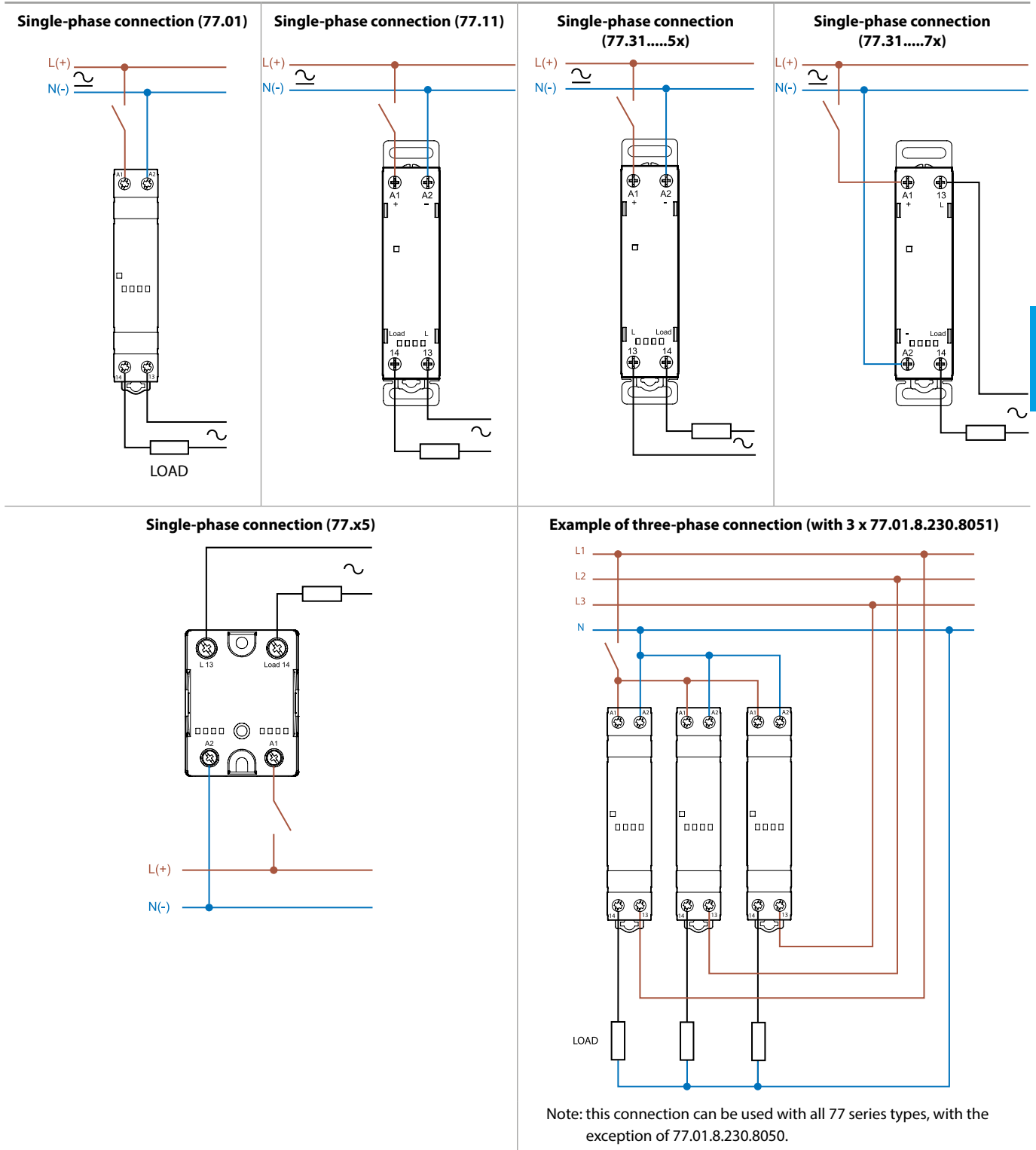

Outline drawings

77.01
Screw terminal

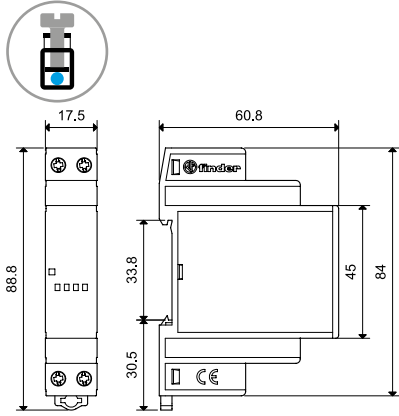

77.11/31
Screw terminal

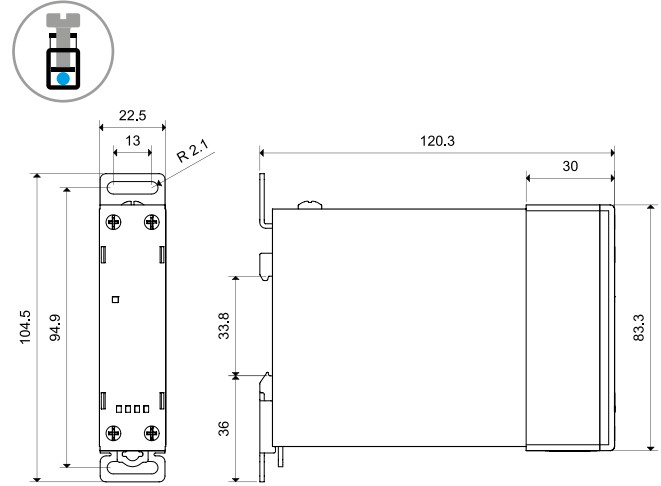

77.x5
Screw terminal (plate clamp)

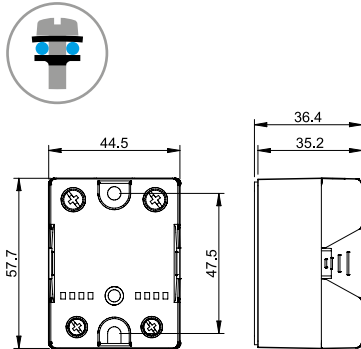

Accessories



Adaptor for panel mounting, plastic, 17.5 mm wide for 77.01 only

020.01

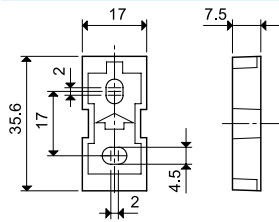

022.09

Separator for rail mounting, plastic, 9 mm wide

022.09

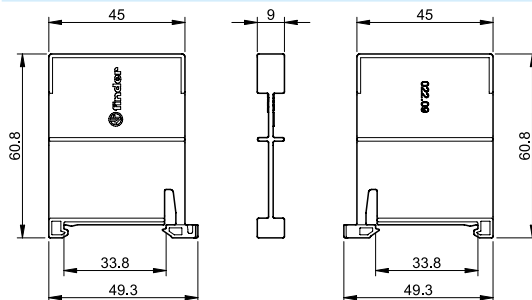

060.72

Sheet of marker tags, plastic, 72 tags, 6 x 12 mm

060.72

77 Series - Solid State Relay

Accessories



077.25

Heat-sink, anodized aluminium, 2 K/W, 65 x 100 mm, for 77.25 only | 077.25

- Both the SSR and 35 mm rail clip mount to the heat-sink using M4 screws (supplied with heat-sink)
- Before assembling to the heat-sink, it is necessary to apply a thin and even layer of thermal conductive paste (not supplied) to the lower metal surface of the SSR

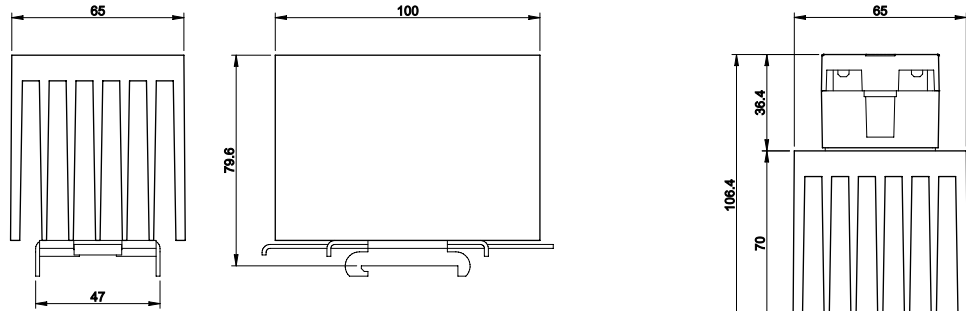

077.25 with 77.25

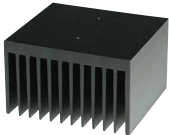

077.55

Heat-sink, anodized aluminium, 0.9 K/W, 111 x 100 mm, for 77.45 and 77.55 | 077.55

- Both the SSR and 35 mm rail clip mount to the heat-sink using M4 screws (supplied with heat-sink)
- Before assembling to the heat-sink, it is necessary to apply a thin and even layer of thermal conductive paste (not supplied) to the lower metal surface of the SSR

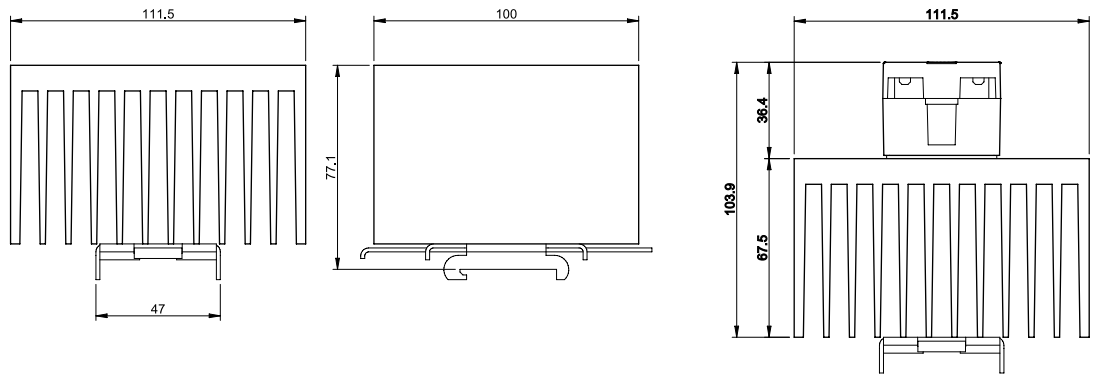

077.55 with 77.45/55

