

# PIR4 with socket GZM4 interface relays



R4 + GZM4

- Interface relay **PIR4 with socket GZM4** consists of: electromagnetic relay **R4**, grey plug-in socket **GZM4**, signalling / protecting module: version **LD** - M41G or M42G or M43G (L - LED green, D - diode, polarization N: +A1/-A2); version **LV** - M91G or M92G or M93G (L - LED green, V - varistor), retainer / retractor clip **GZT4-0040** (plastic), white description plate **GZT4-0035**
- 35 mm rail mount acc. to PN-EN 60715 or on panel mounting with two M3 screws
- May be linked with interconnection strip type **ZGGZ4** • Recognitions, certifications, directives: recognitions R4, RoHS, AUCOTEAM GmbH Berlin - railway standards,

## Contact data

Number and type of contacts		4 CO	
Contact material		<b>AgNi</b>	
Rated / max. switching voltage	AC	250 V / 250 V	
Min. switching voltage		5 V	
Rated load (capacity)	AC1	6 A / 250 V AC	
	AC15	1,5 A / 120 V	0,75 A / 240 V (C300)
	AC3	125 W (single-phase motor)	
	DC1	6 A / 24 V DC (see Fig. 3)	
	DC13	0,22 A / 120 V 0,1 A / 250 V (R300)	
Min. switching current		5 mA	
Max. inrush current		12 A	
Rated current		6 A	
Max. breaking capacity	AC1	1 500 VA	
Min. breaking capacity		0,3 W	
Contact resistance		≤ 100 mΩ	
Max. operating frequency		1 200 cycles/hour	
• at rated load	AC1	18 000 cycles/hour	
• no load			
<b>Coil data</b>			
Rated voltage	50/60 Hz AC	12 ... 230 V	
	DC	12 ... 110 V	
Must release voltage		AC: ≥ 0,2 U <sub>n</sub>	DC: ≥ 0,1 U <sub>n</sub>
Operating range of supply voltage		see Tables 1,2	
Rated power consumption	AC	50 Hz: 1,6 VA	60 Hz: 1,3 VA
	DC	0,9 W	
<b>Insulation according to PN-EN 60664-1</b>			
Insulation rated voltage		250 V AC	
Rated surge voltage		2 500 V 1,2 / 50 μs	
Overvoltage category		II	
Insulation pollution degree		2	
Dielectric strength			
• between coil and contacts		2 500 V AC	type of insulation: basic
• contact clearance		1 500 V AC	type of clearance: micro-disconnection
• pole - pole		2 000 V AC	type of insulation: basic
Contact - coil distance			
• clearance		≥ 1,6 mm	
• creepage		≥ 3,2 mm	
<b>General data</b>			
Operating / release time (typical values)		AC: 10 ms / 8 ms	DC: 13 ms / 3 ms
Electrical life			
• resistive AC1		> 10 <sup>5</sup>	6 A, 250 V AC
• cos φ		see Fig. 2	
Mechanical life (cycles)		> 2 x 10 <sup>7</sup>	
Dimensions (L x W x H)		75 x 27 x 82 mm	
Weight		108 g	
Ambient temperature	• storage	-40...+85 °C	
	• operating	AC: -40...+55 °C	DC: -40...+70 °C
Cover protection category		IP 20	PN-EN 60529
Environmental protection		R4: RTI GZM4: RT0	PN-EN 116000-3
Shock resistance	(NO/NC)	10 g / 5 g	
Vibration resistance		5 g 10...150 Hz	

The data in bold type pertain to the standard versions of the relays.

# PIR4 with socket GZM4 interface relays

**Coil data - DC voltage version**

**Table 1**

Coil code	Rated voltage V DC	Coil resistance at 20 °C Ω	Acceptable resistance	Coil operating range V DC	
				min. (at 20 °C)	max. (at 55 °C)
012DC	12	160	± 10%	9,6	13,2
<b>024DC</b>	<b>24</b>	<b>640</b>	<b>± 10%</b>	<b>19,2</b>	<b>26,4</b>
048DC	48	2 600	± 10%	38,4	52,8
110DC	110	13 600	± 10%	88,0	121,0

The data in bold type pertain to the standard versions of the relays.

**Coil data - AC 50/60 Hz voltage version**

**Table 2**

Coil code	Rated voltage V AC	Coil resistance at 20 °C Ω	Acceptable resistance	Coil operating range V AC	
				min. (at 20 °C)	max. (at 55 °C)
012AC	12	39,5	± 10%	9,6	13,2
<b>024AC</b>	<b>24</b>	<b>158,0</b>	<b>± 10%</b>	<b>19,2</b>	<b>26,4</b>
048AC	48	640,0	± 10%	38,4	52,8
120AC	120	3 770,0	± 10%	96,0	132,0
<b>230AC</b>	<b>230</b>	<b>16 100,0</b>	<b>± 10%</b>	<b>184,0</b>	<b>253,0</b>

The data in bold type pertain to the standard versions of the relays.

## Dimensions

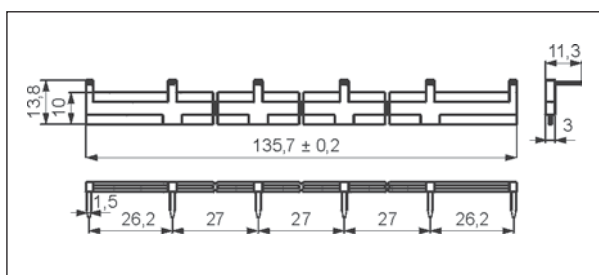
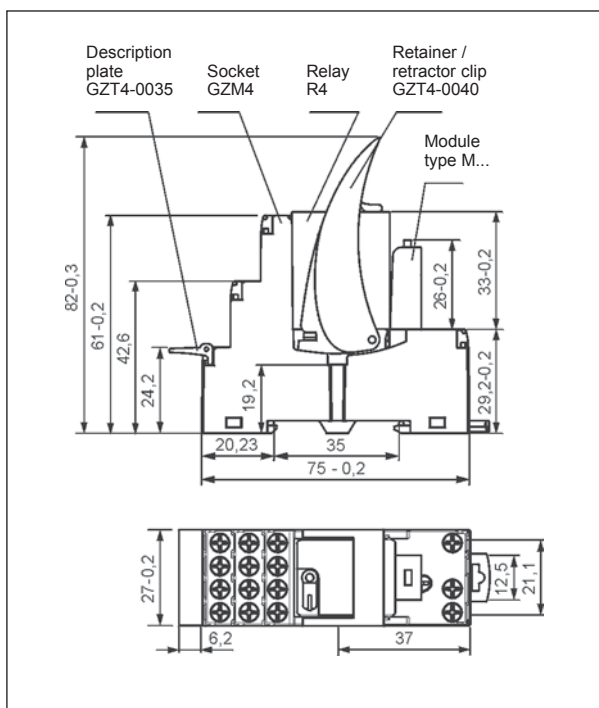

Interconnection strip type **ZGGZ4**

## Connection diagrams

(screw terminals side view)

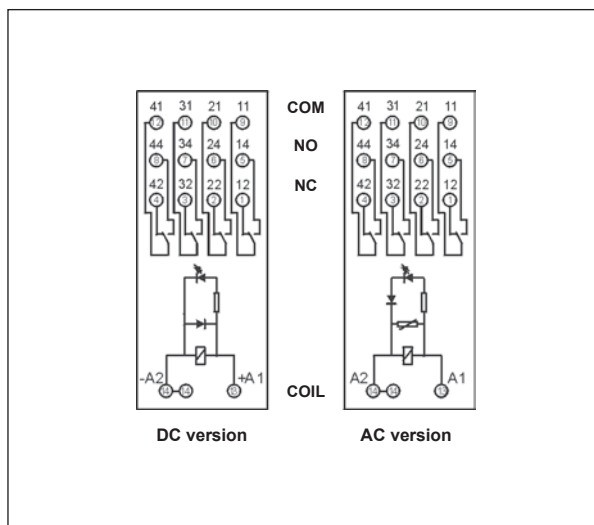

Electrical life at AC resistive load.  
Switching frequency: 1 200 cycles/hour

Fig. 1

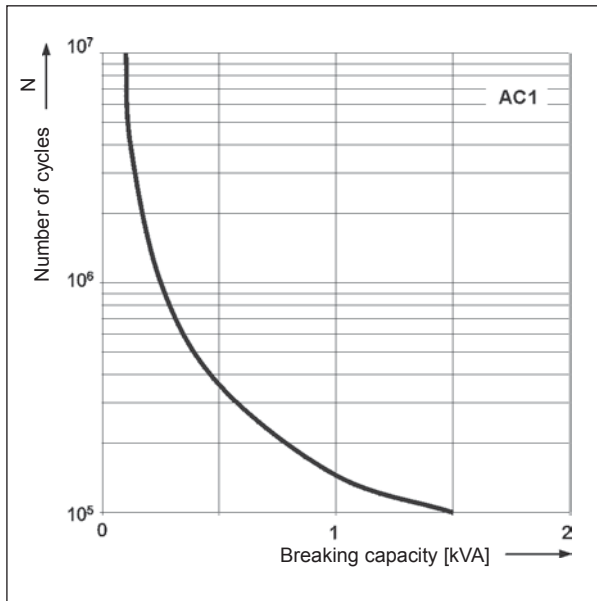

Electrical life reduction factor  
at AC inductive load

Fig. 2

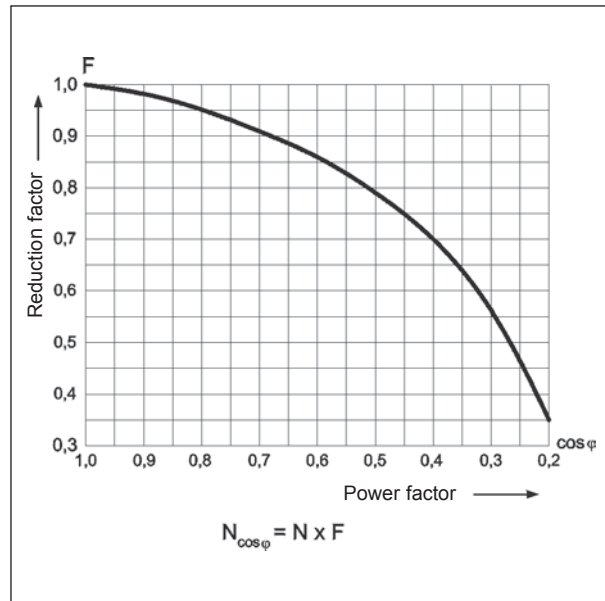

Max. DC breaking capacity  
A - resistive load DC1  
B - inductive load L/R = 40 ms

Fig. 3

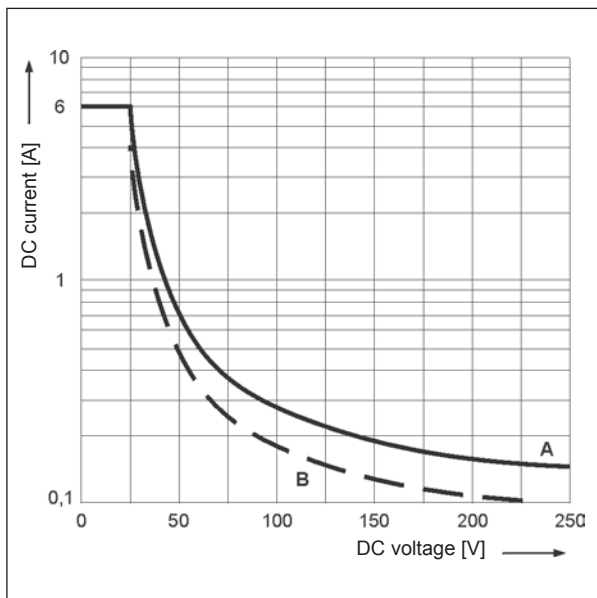



## Interconnection strips ZGGZ4



PIR4-...-00L.

ZGGZ4

### ZGGZ4 for:

Plug-in sockets	Relays for plug-in sockets	Interface relays ②
GZT2	R2...WT	PIR2-...-00L. (GZM2 + R2...WT)
GZM2		PIR3-...-00L. (GZM3 + R3...WT)
GZT3	R3...WT	PIR4-...-00L. (GZM4 + R4...WT)
GZM3		
GZT4	R4...WT	
GZM4		

② Interface relay PIR2 (PIR3, PIR4) is offered as a set: plug-in socket GZM2 (GZM3, GZM4) + miniature industrial relay R2 (R3, R4) + signalling / protecting module type M... + retainer / retractor clip GZT4-0040 + description plate GZT4-0035.

### Interconnection strip ZGGZ4

- designed for the co-operation with plug-in sockets of miniature industrial relays and with interface relays PIR2, PIR3 and PIR4, which are equipped with screw terminals; sockets and relays are mounted on 35 mm rail mount acc. to PN-EN 60715,
- bridges common input signals (coil terminals A1 or A2) or output signals - see photo at the top,
- maximum permissible current is 10 A / 250 V AC,
- possibility of connection of 6 sockets or relays,
- colours of strips: **ZGGZ4-1** grey, **ZGGZ4-2** black.

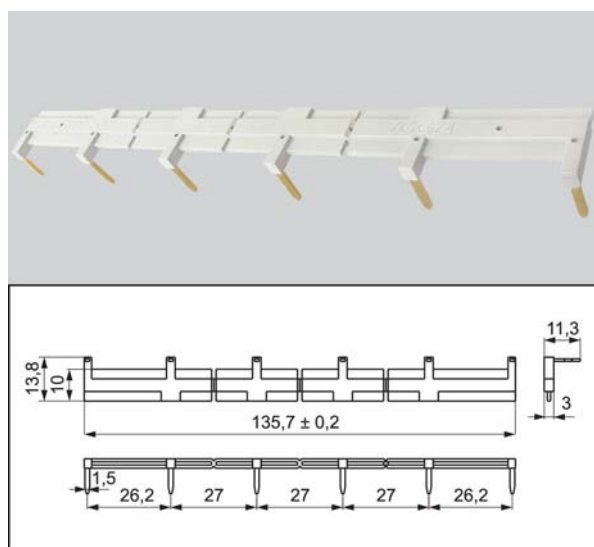

21.04.2012