

**Special Load PCB Relay RP3SL**

- 1 pole 16A, 1 form A (NO) contact
- For high inrush currents up to 120A
- Mono- or bistable
- 4kV/8mm coil-contact

Typical applications  
Lighting control, timers, motor control, building automation.



**Approvals**  
VDE Cert. No. 40025448 (DC versions only), UL E214024  
Technical data of approved types on request.

Contact Data	
Contact arrangement	1 form A (NO)
Rated voltage	250VAC
Max. switching voltage	400VAC
Rated current	
flux proof version	16A
wash tight version	12A
Limiting making current	
max. 4 s, duty factor 10 %	25A
max. 20 ms (incandescent lamp)	120A
Breaking capacity max.	
flux proof version	4000VA
wash tight version	3000VA
Contact material	AgSnO
Frequency of operation, with/without load	960/72000h <sup>-1</sup>
Operate/release time max., monostable	14/12ms
Set/reset time max., bistable	30/25ms
Bounce time max.	
monostable	5/7ms
bistable	5/15ms

Contact ratings			
Type	Contact	Load	Cycles
<b>IEC61810</b>			
RP3SL	A (NO)	16A, 250VAC resistive, 70°C	50x10 <sup>3</sup>
RP7SL	A (NO)	12A, 250VAC resistive, 70°C	100x10 <sup>3</sup>

Mechanical endurance		
monostable		>20x10 <sup>6</sup> operations
bistable		>1x10 <sup>6</sup> operations

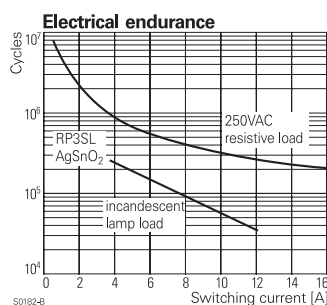
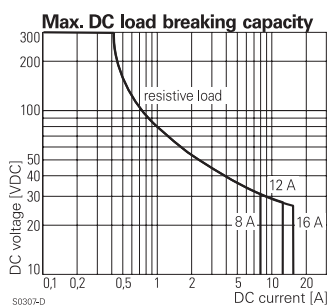

**Coil Data**

Coil data, monostable coil	
Coil voltage range	5 to 110VDC
Operative range, IEC 61810	
flux proof version	2
wash tight version	1

Coil versions, DC coil					
Coil code	Rated voltage VDC	Operate voltage VDC	Release voltage VDC	Coil resistance Ω±10% <sup>1)</sup>	Rated coil power mW
005	5	3.8	0.5	54	500
006	6	4.5	0.6	68	500
012	12	9.0	1.2	270	500
024	24	18.0	2.4	1100 <sup>1)</sup>	500
048	48	36.0	4.8	4400 <sup>1)</sup>	500
060	60	45.0	6.0	6540 <sup>1)</sup>	500

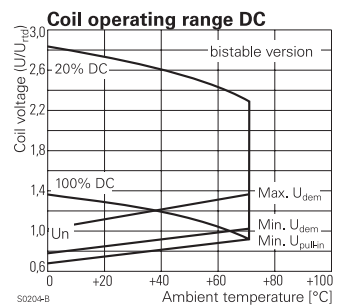
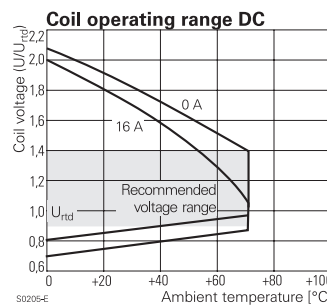

Coil Data, bistable coil		1 coil	2 coils
Coil voltage range		5 to 24VDC	
Operative range, IEC 61810		1	
Reset voltage min/max, % of Urtd		70/110%	75/120%
Min./Max. energization duration		20ms/1min at < 50%DF	

Coil versions, bistable						
Coil code	Rated voltage VDC	Set voltage VDC	Reset voltage VDC	Reset R1 Ω/W	Coil resistance Ω±10% <sup>1)</sup>	Rated coil power mW
<b>Coil versions, bistable 1 coil</b>						
A05	5	3.7	3.6	39/0.5	21	1250
A12	12	9.0	8.7	220/0.5	115	1250
A24	24	18.0	16.7	820/0.5	460	1250
<b>Coil versions, bistable 2 coils</b>						
F12	12		9.0		105 <sup>1)</sup>	1250
F24	24		18.0		460 <sup>1)</sup>	1250

1) Coil resistance ±15% .  
All figures are given for coil without pre-energization, at ambient temperature +23°C, duty factor 20%. Other coil voltages on request.

**Special Load PCB Relay RP3SL (Continued)**

**Insulation Data**

Initial dielectric strength	
between open contacts	2000V <sub>rms</sub>
between contact and coil	4000V <sub>rms</sub>
Clearance/creepage	
between contact and coil	≥8/8mm
Material group of insulation parts	
Tracking index of relay base	PTI250V

**Other Data**

Material compliance: EU RoHS/ELV, China RoHS, REACH, Halogen content refer to the Product Compliance Support Center at [www.te.com/customersupport/rohssupportcenter](http://www.te.com/customersupport/rohssupportcenter)

Ambient temperature	
flux proof version	-40 to +70°C
wash tight version	-40 to +35°C
Category of environmental protection	
IEC 61810	RTII - flux proof, RTIII - wash tight
Vibration resistance (functional), form A contact	20g
Shock resistance (destructive)	100g
Terminal type	PCB-THT
Mounting distance, 12A/16A	0mm/≥3mm
Weight	18g
Resistance to soldering heat THT, IEC 60068-2-20	
flux proof version	270°C/10s
wash tight version	260°C/5s
Packaging/unit	
monostable and bistable 1 coil version	tube/20 pcs., box/500 pcs.
bistable 2coil version	tray/25 pcs., box/100 pcs.

**Circuit scheme for bistable 1 coil**

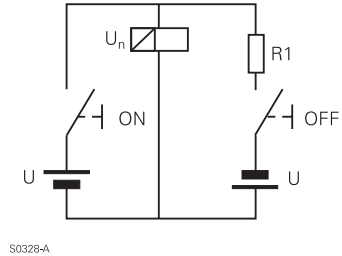

**PCB layout / terminal assignment**

Bottom view on solder pins

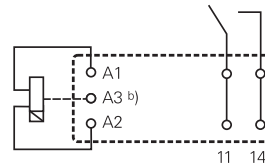
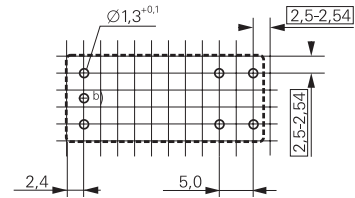

Bistable versions:  
Indicated contact position during or after coil energization with reset voltage.

2-coil versions:  
Operate A2, A3  
Reset A1, A3

b) for 2 coil version only

**Dimensions**

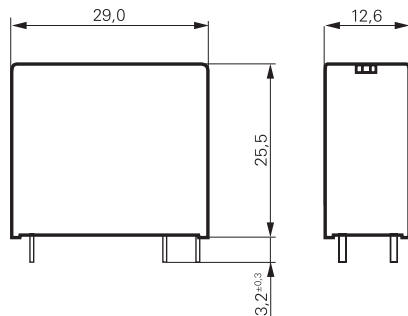

**Special Load PCB Relay RP3SL** (Continued)

<b>Product code structure</b>	Typical product code	<b>RP</b>	<b>3</b>	<b>SL</b>	<b>012</b>
<b>Type</b>	RP Special Load PCB Relay RP 3 SL				
<b>Version</b>	<b>3</b> Flux proof	<b>7</b> Wash tight			
<b>Contact configuration / contact material</b>	SL 1 form A contact (1 NO), AgSnO <sub>2</sub>				
<b>Coil</b>	Coil code: please refer to coil versions table				

Product code	Version	Contact material	Coil version	Coil	Part number
RP3SL005	1 form A (NO) contact	AgSnO	DC coil	5VDC	1393230-7
RP3SL012	16A			12VDC	1393230-9
RP3SL018	flux proof			18VDC	1-1393230-0
RP3SL024				24VDC	1-1393230-1
RP3SL048				48VDC	1-1393230-2
RP3SL060				60VDC	1-1393230-3
RP3SLA06			Bistable 1 coil	6VDC	1393230-2
RP3SLA24				24VDC	1393230-4
RP3SLF12			Bistable 2 coils	12VDC	1393230-5

This list represents the most common types and does not show all variants covered by this datasheet.  
Other types on request.