

# HFV4

# AUTOMOTIVE RELAY

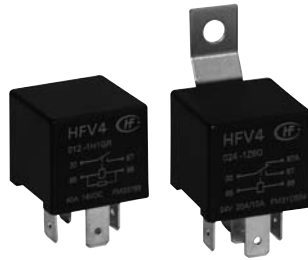

### Typical Applications

Fog lamp & headlight control, Rear window defogger, Air-conditioning, Fuel pump control, Cooling fan control, Battery disconnection device

### Features

- 40A switching capability
- Various mounting terminations available
- 1 Form A & 1 Form C contact arrangement
- Plastic sealed and dust protected types available
- RoHS & ELV compliant

## CHARACTERISTICS

Contact arrangement	1A, 1C
Voltage drop (initial)	NO: Typ.20mV, 250mV max. (at 10A) NC: Typ.30mV, 250mV max. (at 10A)
Max. continuous current <sup>1) 10)</sup>	NO: 60A (at 23°C) NC: 40A (at 23°C)
Max. switching current <sup>10)</sup>	Make (NO): 150A <sup>2)</sup> Break (NO): 40A (Resistive, 13.5VDC)
Max. switching voltage	See "Load limit curve"
Min. contact load	1A 6VDC
Electrical endurance	See "CONTACT DATA"
Mechanical endurance	1 x 10 <sup>6</sup> OPS (300 OPS/min)
Initial insulation resistance	100MΩ (at 500VDC)
Dielectric strength <sup>3)</sup>	between contacts: 500VAC between coil & contacts: 500VAC
Operate time <sup>10)</sup>	Max.: 7ms (at nomi. vol.)
Release time <sup>10)</sup>	Max.: 5ms <sup>4)</sup>
Ambient temperature	-40°C to 125°C
Vibration resistance <sup>5) 10)</sup>	5Hz to 22.3Hz 10mm DA 22.3Hz to 500Hz 98m/s <sup>2</sup>

Shock resistance <sup>5) 10)</sup>	294m/s <sup>2</sup>
Flammability <sup>6)</sup>	UL94-HB or better (meets FMVSS 302)
Termination	QC <sup>7)</sup>
Construction	Plastic sealed, Dust protected
Unit weight	Weather-proof cover: Approx. 55g Others: Approx. 35g
Mechanical data <sup>8)</sup>	cover retention (pull & push): 200N min. terminal retention (pull & push): 100N min. terminal resistance to bending (front & side): 10N min. <sup>9)</sup>

- 1) For NO contacts, measured when applying 100% rated voltage on coil. For NC contacts, measured when applying zero voltage on coil.
- 2) Inrush peak current under lamp load, at 13.5VDC.
- 3) 1min, leakage current less than 1mA.
- 4) The value is measured when voltage drops suddenly from nominal voltage to 0 VDC and coil is not paralleled with suppression circuit.
- 5) When energized, opening time of NO contacts shall not exceed 1ms, when non-energized, opening time of NC contacts shall not exceed 1ms, meantime, NO contacts shall not be closed.
- 6) FMVSS: Federal Motor Vehicle Safety Standard.
- 7) Do NOT knock on relays with hard objects such as rubber rod and rubber hammer during mounting, which might lead to relay damage.
- 8) Only valid for QC version.
- 9) Test point is at 2mm away from terminal end, and after removing testing force, the terminal transfiguration shall not exceed 0.5mm.
- 10) Only for the 12VDC coil voltage type.

## CONTACT DATA <sup>5)</sup>

Load voltage	Load type		Load current A			On/Off ratio		Electrical endurance <sup>3)</sup> OPS	Contact material	Load wiring diagram <sup>4)</sup>	Ambient temp.
			1C		1A	On s	Off s				
			NO	NC	NO						
13.5VDC	Resistive	Make	40	30	40	1.5	1.5	1×10 <sup>5</sup>	AgSnO <sub>2</sub>	See diagram 1	See Ambient Temp. Curve
		Break	40	30	40						
	Lamp <sup>1)</sup>	Make	150 <sup>2)</sup>	---	150 <sup>2)</sup>	2	2	1×10 <sup>5</sup>	AgSnO <sub>2</sub>	See diagram 2	
		Break	30	---	30						
	Inductive	Make	80	---	80	2	2	1×10 <sup>5</sup>	AgSnO <sub>2</sub>	See diagram 3	
		Break	33	---	33						
27VDC	Resistive	Make	20	10	20	2	2	1×10 <sup>5</sup>	AgSnO <sub>2</sub>	See diagram 1	at 23°C
		Break	20	10	20						



HONGFA RELAY

ISO9001, ISO/TS16949, ISO14001, OHSAS18001, IECQ QC 080000 CERTIFIED

2017 Rev. 1.00

- 1) The load in the table excludes flasher. When applied in flasher, a special silver alloy (AgSnO<sub>2</sub>) contact material should be used and the customer special code should be (170) as a suffix. Please heed the anode and cathode's request when wired, terminal 30 should connect with anode.
- 2) Corresponds to the peak inrush current on initial actuation (cold filament).
- 3) A low resistive or diode suppression device in parallel to the relay coil increases the release time and reduces the life time caused by increased erosion and / or higher risk of contact welding.
- 4) The load wiring diagrams are listed below (Ratings of NO, NC are tested based on different samples separately) :

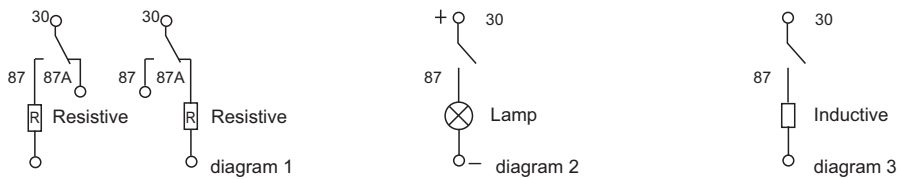

- 5) Loads mentioned in this chart is for relays with no parallel diode or Zener Diode. For those with parallel diode, Zener Diode or other components, please contact Hongfa for more technical supports.  
Please also contact Hongfa if the actual application load is different from what mentioned above.

COIL DATA								at 23°C	
	Nominal voltage VDC	Pick-up voltage VDC max.	Drop-out voltage VDC min.	Coil resistance x(1±10%)Ω	Parallel resistance <sup>2)</sup> x(1±5%)Ω	Equivalent resistance Ω	Power consumption W	Max. allowable overdrive voltage <sup>1)</sup> VDC	
								at 23°C	at 85°C
Weather-proof cover	6	3.6	0.6	22	---	---	1.6	10.1	7.9
	6	3.6	0.6	22	180	19.6	1.8	10.1	7.9
	12	7.2	1.2	90	---	---	1.6	20.2	15.7
	12	7.2	1.2	90	680	79.5	1.8	20.2	15.7
	24	14.4	2.4	350	---	---	1.6	40.5	31.5
	24	14.4	2.4	350	2700	309.8	1.9	40.5	31.5
Others	6	3.9	0.6	22	---	---	1.6	10.1	7.9
	6	3.9	0.6	22	180	19.6	1.8	10.1	7.9
	12	7.8	1.2	85	---	---	1.7	20.2	15.7
	12	7.8	1.2	85	680	75.6	1.9	20.2	15.7
	24	15.6	2.4	350	---	---	1.6	40.5	31.5
	24	15.6	2.4	350	2700	309.8	1.9	40.5	31.5

- 1) Max. allowable overdrive voltage is stated with no load applied, illustrated with dust cover version.
- 2) Illustrated with the type with parallel resistor (680Ω, 12V), (2700Ω, 24V).

## ORDERING INFORMATION

Type	HFV4 / 012 -1H 1 S G R (XXX)
Coil voltage	006: 6VDC 012: 12VDC 024: 24VDC
Contact arrangement	1H: 1 Form A 1Z: 1 Form C
Version	1: QC Terminal 4: Plastic Bracket 3: Weatherproof Cover (Without metal bracket) 5: Weatherproof Cover (With metal bracket) 6: Metal Bracket
Construction <sup>1)</sup>	S: Plastic sealed Nil: Dust protected
Contact Material	G: AgSnO <sub>2</sub>
Parallel coil components <sup>2)</sup>	R: Parallel transient suppression resistors(680Ω, 12V) (2700Ω, 24V) R1: Parallel transient suppression resistors(560Ω, 12V) (1200Ω, 24V) R2: Parallel transient suppression resistors(470Ω, 12V) (1000Ω, 24V) D1: Parallel transient suppression diode, with anode connected to terminal#86 D2: Parallel transient suppression diode, with anode connected to terminal#85 Nil: Without parallel components
Special code <sup>3)</sup>	XXX: Customer special requirement Nil: Standard

- Notes: 1) Dust protected version is recommended.  
2) If the switch-off peak voltage of coil is required to be smaller than 100V, R1 or R2 shall be used (measured voltage of 12V is 13.5V, that of 24V is 27V); If parallel diode, Zener Diode or other components are required, please contact Hongfa for more technical supports.  
3) The customer special requirement express as special code after evaluating by Hongfa. e.g. (170) stands for flasher load.

# OUTLINE DIMENSIONS AND WIRING DIAGRAM

Unit: mm

## Outline Dimensions

HFV4/□□□-1□1□□□(XXX)

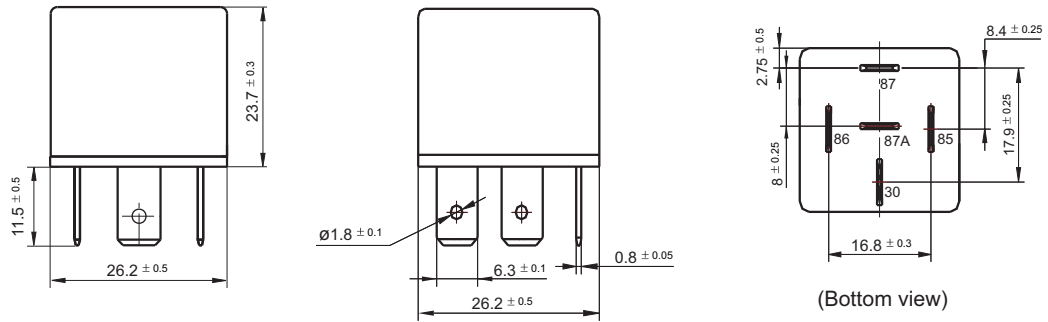

HFV4/□□□-1□3□□□(XXX)

HFV4/□□□-1□5□□□(XXX)

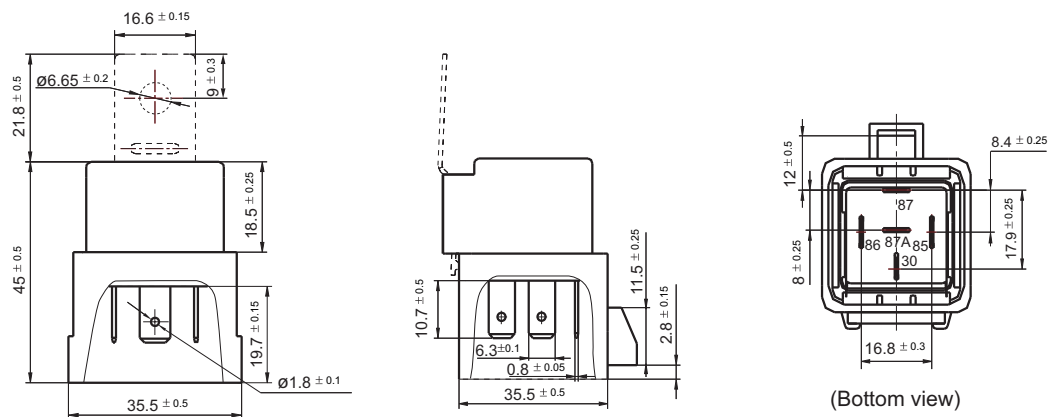

Outline Dimensions

HFV4/□□□-1□4□□□(XXX)

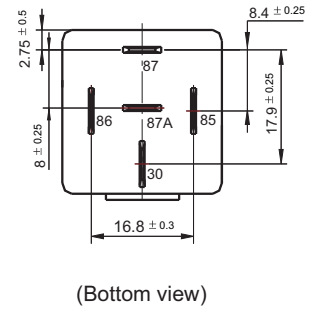
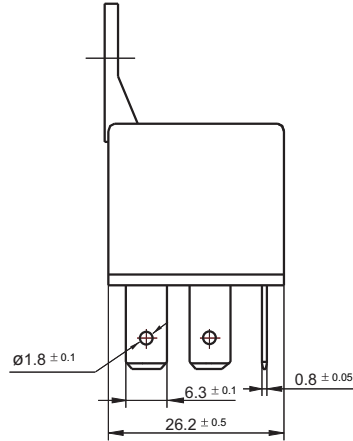
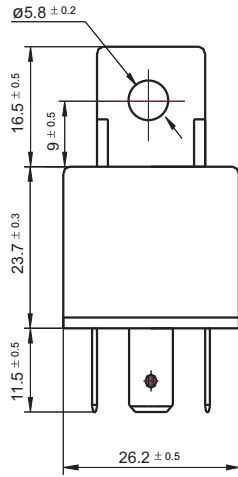

HFV4/□□□-1□6□□□(XXX)

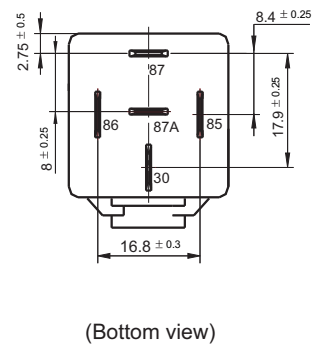
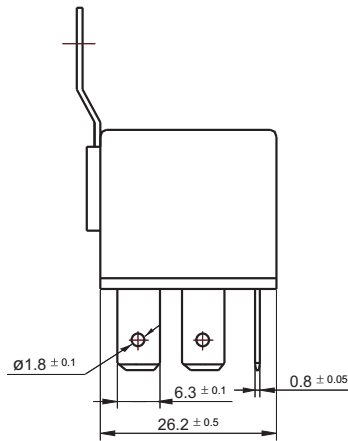
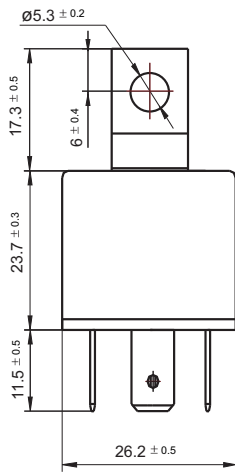

Remark: Terminal vertical deviation tolerance is 0.3mm.

Wiring Diagram

HFV4/□□□-1H□□□(XXX)

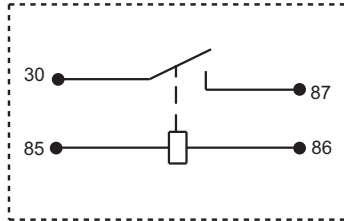

HFV4/□□□-1Z□□□(XXX)

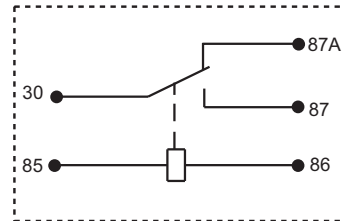

HFV4/□□□-1H□□□R(XXX)

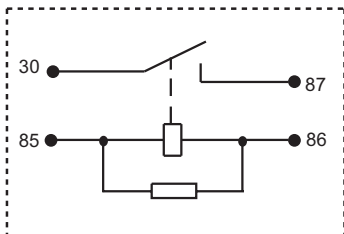

HFV4/□□□-1Z□□□R(XXX)

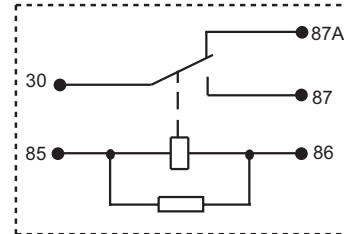

HFV4/□□□-1H□□□D1(XXX)

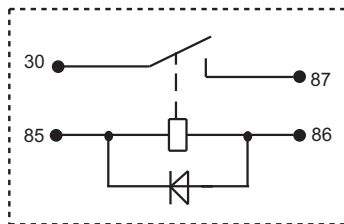

HFV4/□□□-1Z□□□D1(XXX)

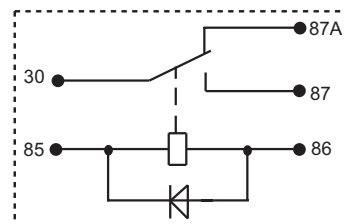

HFV4/□□□-1H□□□D2(XXX)

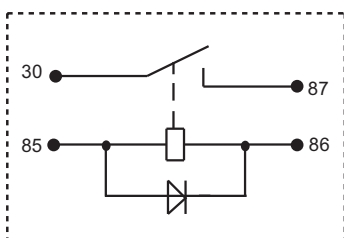

HFV4/□□□-1Z□□□D2(XXX)

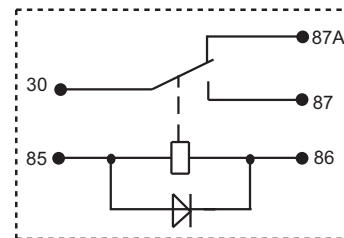

## CHARACTERISTIC CURVES

### 1. Coil operating voltage range

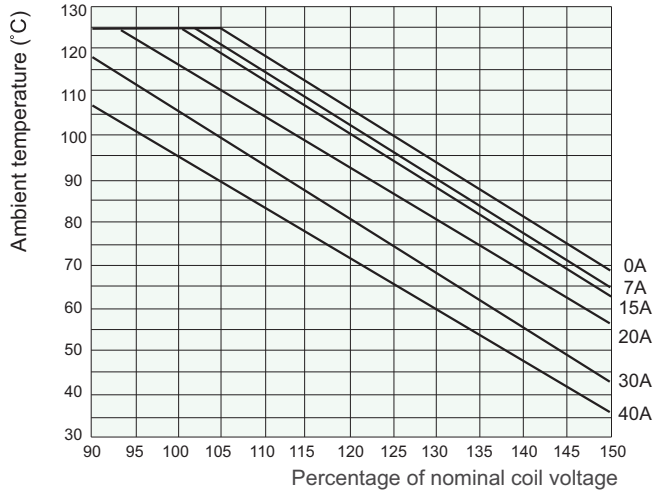

- 1) There should be no contact load applied when maximum continuous operation voltage is applied on coil.
- 2) This chart takes dust protected, 12VDC coil voltage version as example.
- 3) The maximum allowable coil temperature is 180°C. Considering the coil temperature rise which is measured by resistance is average value, we recommend the coil temperature should be below 170°C under the different application ambient, different coil voltage and different load etc.
- 4) If the actual operating coil voltage is out of the specified range, please contact Hongfa for further details.

### 2. Load limit curve (at 23°C)

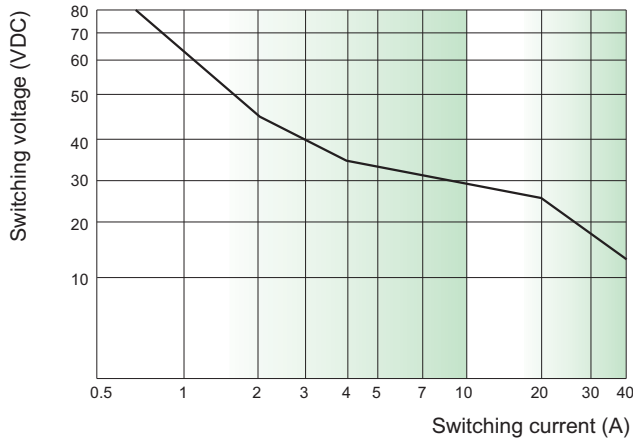

- 1) This chart takes NO contact, resistive load as example.
- 2) The load and electrical endurance tests are made according to "CONTACT DATA" parameters' table. If actual load voltage, current, or operate frequency is different from "CONTACT DATA" table, please arrange corresponding tests for confirmation.

### 3. Ambient temperature curve of the electrical endurance test

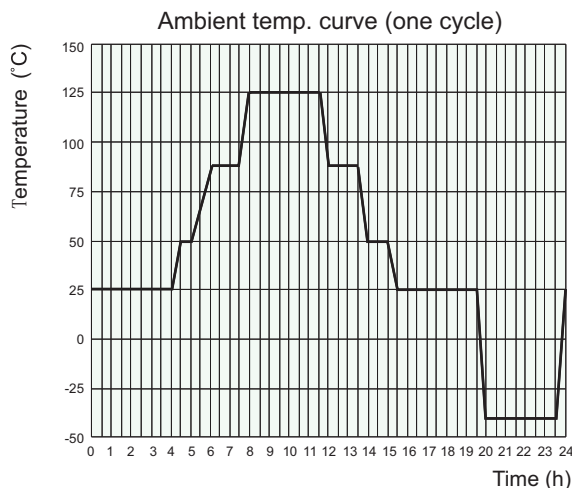

- 1) The minimum temperature is -40°C.
- 2) The maximum temperature is 125°C.

#### Disclaimer

The specification is for reference only. See to "Terminology and Guidelines" for more information. Specifications subject to change without notice. In case there is specific criterion (such as mission profile, technical specification, PPAP etc.) checked and agreed by and between customer and Hongfa, this specific criterion should be taken as standard regarding any requirement on Hongfa product.

We could not evaluate all the performance and all the parameters for every possible application. Thus the user should be in a right position to choose the suitable product for their own application. If there is any query, please contact Hongfa for the technical service. However, it is the user's responsibility to determine which product should be used only.

© Xiamen Hongfa Electroacoustic Co., Ltd. All rights of Hongfa are reserved.