

K41 Series Make & Break Load Switching — 5.0 kV Relays

K41A, K41B Product Facts

- High current carry rating
- Vacuum dielectric for power switching low current loads
- Glazed ceramics for low current leakage
- Compact, space-saving design
- Meets requirements of MIL-R-83725
- QPL versions available, M83725/21 & M83725/22

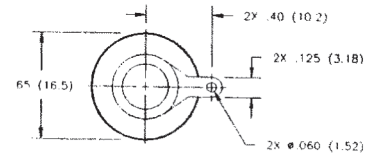
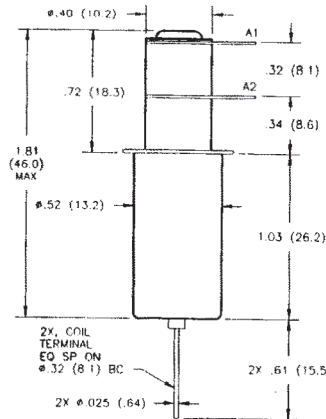
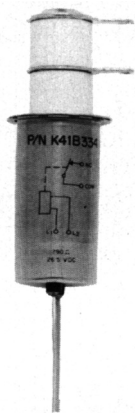

K41C Product Facts

- Single pole, double throw version
- Vacuum dielectric for power switching low current loads
- RF ratings to 32 MHz
- Long life: 2 million cycles
- Meets requirements of MIL-R-83725
- QPL version available, M83725/23

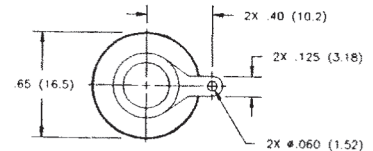
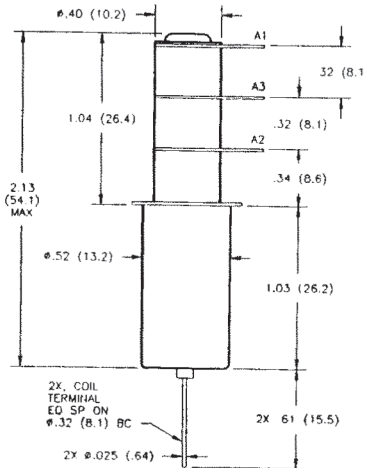
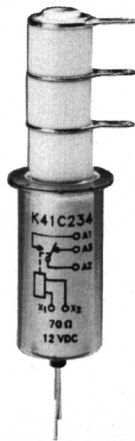

Product Specifications for K41A, K41B and K41C

Contact Arrangement —

K41A — SPST-NO
K41B — SPST-NC
K41C — SPDT

Contact Form —

K41A — A
K41B — B
K41C — C

Test Voltage, DC or 60 Hz (Peak) —
6 kV

Rated Operating Voltage (Peak) —

DC or 60 Hz — 5 kV
2.5 MHz — 4.5 kV
16 MHz — 3.5 kV
32 MHz — 2.8 kV

Continuous Carry Current, Max. —

DC or 60 Hz — 30 A
2.5 MHz — 24 A
16 MHz — 16 A
32 MHz — 12 A
Coil Hi-Pot (Vrms, 60 Hz) — 500 A

Contact Capacitance —

Between Open Contacts — 1.2 pF
Open Contacts to Ground — 1.2 pF

Contact Resistance, Max. —

0.02 ohm

Operate Time, Max. —

10 ms

Release Time, Max. —

10 ms

Shock, 11ms, 1/2 Sine (Peak) —

50 g

Vibration —

Peak — 10 g (55 to 2000 Hz)

Operating Ambient Temperature Range —

-55°C to +125°C

Mechanical Life —

2 million cycles

Weight, Nominal —

28.35 g (1.0 oz.)

Coil Data

Nominal Volts DC	12 Vdc	26.5 Vdc	115 Vdc
Pickup, Max.	8 Vdc	16 Vdc	80 Vdc
Dropout	.5-5 Vdc	1-10 Vdc	5-50 Vdc
Coil Resistance (±10%)	70 Ω	290 Ω	4700 Ω

Ratings listed are for 25°C, sea level conditions

Ordering Information

Sample Part Number ▶

K41 A 3 3 4

Series: _____

Contact Form: _____

A = SPST-NO B = SPST-NC C = SPDT

Coil Voltage: _____

2 = 12 Vdc, Bus Wire 3 = 26.5 Vdc, Bus Wire
5 = 115 Vdc, Bus Wire 7 = 12 Vdc, Turret Terminal*
8 = 26.5 Vdc, Turret Terminal*
9 = 115 Vdc, Turret Terminal*

High Voltage Connections: _____

3 = Solder Connection

Mounting: _____

2 = Flanged

4 = Standard

For factory-direct application assistance, dial 800-253-4560, ext. 2055, or 805-220-2055.

***See page 7-87 for turret terminal dimensions and mounting methods.**

K41 Series Make & Break Load Switching — 5.0 kV Relays

K41P

Product Facts

- Fast, 6 millisecond operate time
- Vacuum dielectric for power switching low current loads
- Latching actuator for low power consumption
- Ideal for frequency agile communication systems
- Meets requirements of MIL-R-83725
- QPL version available, M83725/24

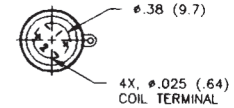
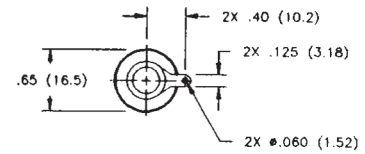
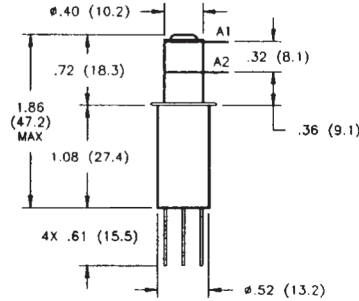
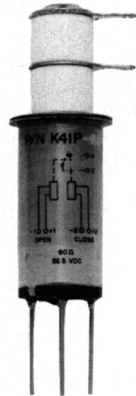

K41R

Product Facts

- Latching actuator for low power consumption
- Vacuum dielectric for power switching low current loads
- Meets requirements of MIL-R-83725
- Latching version of K41C

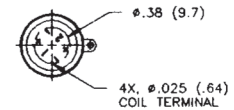
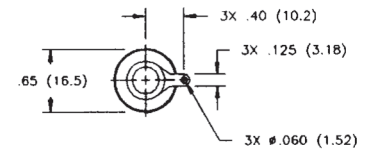
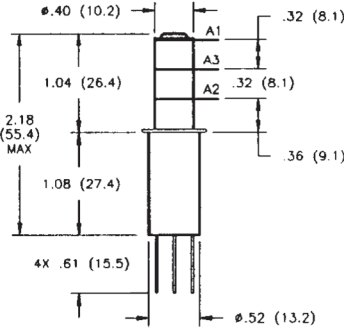
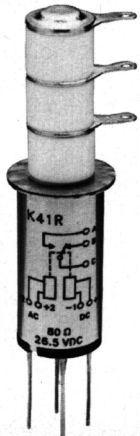

Product Specifications for K41P and K41R

Contact Arrangement —
 K41P — SPST-Latching
 K41R — SPDT-Latching

Contact Form —
 K41P — P
 K41R — R

Test Voltage, DC or 60 Hz (Peak) —
 6 kV

Rated Operating Voltage (Peak) —
 DC or 60 Hz — 5 kV
 2.5 MHz — K41P — 4.5 kV
 K41R — 4.0 kV
 16 MHz — K41P — 3.5 kV
 K41R — 3.2 kV
 32 MHz — K41P — 2.8 kV
 K41R — 2.5 kV

Continuous Carry Current, Max. —
 DC or 60 Hz — 30 A
 2.5 MHz — K41P — 20 A
 K41R — 16 A
 16 MHz — K41P — 13 A
 K41R — 10 A
 32 MHz — K41P — 10 A
 K41R — 6 A
 Coil Hi-Pot (Vrms, 60 Hz) — 500 A

Contact Capacitance —
 Between Open Contacts —
 K41P — 1.2 pF
 K41R — 1.6 pF
 Open Contacts to Ground —
 K41P — 1.2 pF
 K41R — 1.6 pF

Contact Resistance, Max. —
 0.02 ohm

Operate Time, Max. — 6 ms

Release Time, Max. — N/A

Shock, 11ms, 1/2 Sine (Peak) —
 K41P — 50 g
 K41R — 30 g

Vibration —
 Peak — 10 g (55 to 2000 Hz)

Operating Ambient Temperature Range — -55°C to +125°C

Insulation Resistance —
 Initial — 10 gigaohms

Mechanical Life — 1 million cycles

Weight, Nominal —
 28.35 g (1.0 oz.)

Coil Data

Volts, Nominal	26.5 Vdc
Reset & Latch, Max.	16 Vdc
Dropout	N/A
Coil Resistance (±10%)	80 Ω

Ratings listed are for 25°C, sea level conditions.

Ordering Information

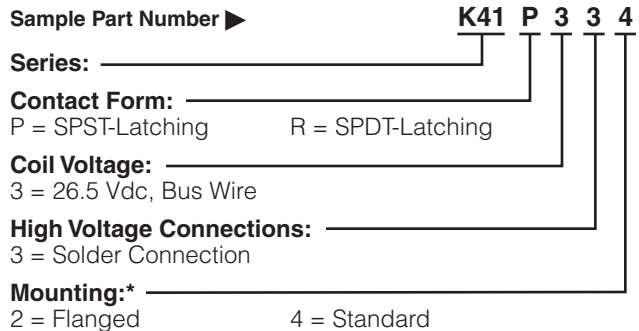

*See page 7-87 for mounting methods.

For factory-direct application assistance, dial 800-253-4560, ext. 2055, or 805-220-2055.