

Protection Equipment



	Price groups PG 14O, 41B, 41E, 41F, 41G, 41H, 41J, 42F, 42J		Overload relays
7/2	Introduction	7/71	General data <u>SIRIUS 3RU2 thermal overload relays</u>
	Motor starter protectors/ circuit breakers <u>SIRIUS 3RV2 motor starter protectors/ circuit breakers</u>	7/78	<u>3RU2 for standard applications</u> NEW
7/7	General data	7/88	<u>Accessories</u> NEW <u>SIRIUS 3RB3 electronic overload relays</u>
7/26	For motor protection NEW	7/90	<u>3RB30, 3RB31 for standard applications</u> NEW
7/30	For motor protection with overload relay function NEW	7/100	<u>Accessories</u> NEW <u>SIRIUS 3RB2 electronic overload relays</u>
7/32	For starter combinations NEW	7/102	3RB20, 3RB21 for standard applications
7/34	For transformer protection	7/112	Accessories for 3RB20, 3RB21
7/35	For system protection according to UL 489/CSA C22.2 No.5 NEW	7/114	3RB22, 3RB23 for high-feature applications
7/36	For transformer protection according to UL 489/CSA C22.2 No.5	7/122	3RB24 for IO-Link for high-feature applications
	Accessories	7/129	Current measuring modules for 3RB22, 3RB23, 3RB24
7/37	- Mountable accessories	7/133	Accessories for 3RB22, 3RB23, 3RB24
7/40	- <u>Busbar accessories</u> NEW		
7/43	- Rotary operating mechanisms		<u>Note:</u>
7/45	- <u>Mounting accessories</u> NEW		The 3RV1, 3RU1 and 3RB2 devices (sizes S00/S0 to S12) can be found
7/52	- Enclosures and front plates		- in the Catalog Add-On IC 10 AO · 2016 at the Information and Download Center
7/55	3RV29 infeed system <u>SIRIUS 3RV1 motor starter protectors/ circuit breakers</u>		- in the interactive Catalog CA 01 - in the Industry Mall
7/60	For fuse monitoring		Conversion tool, e.g. from
7/61	For distance protection <u>SIRIUS 3RV1 molded case motor starter protectors up to 800 A</u>		- 3RV1 to 3RV2 - 3RU11 to 3RU21 - 3RB20/3RB21 to 3RB30/3RB31
7/62	General data		see www.siemens.com/sirius/conversion-tool
7/67	For motor protection		
7/68	For starter combinations Accessories		
7/69	- Mountable accessories		
7/70	- Rotary operating mechanisms, mounting accessories		

Protection Equipment

Introduction

Overview



Type	3RV20		3RV21		3RV23		3RV24		3RV27		3RV28										
SIRIUS 3RV2 motor starter protectors/circuit breakers																					
Applications																					
• System protection	✓ ¹⁾		✓ ¹⁾		--		--		✓		✓										
• Motor protection	✓		--		--		--		--		--										
• Motor protection with overload relay function	--		✓		--		--		--		--										
• Starter combinations	--		--		✓		--		--		--										
• Transformer protection	--		--		--		✓		✓		✓										
Size	S00, S0, S2, S3		S00, S0, S2, S3		S00, S0, S2, S3		S00, S0, S2		S00, S0, S3		S00, S0										
Rated current I_n																					
• Size S00	A	Up to 16	Up to 16		Up to 16		Up to 16		Up to 15		Up to 15										
• Size S0	A	Up to 40	Up to 32		Up to 40		Up to 25		Up to 22		Up to 22										
• Size S2	A	Up to 80	Up to 80		Up to 80		Up to 65		--		--										
• Size S3	A	Up to 100	Up to 100		Up to 100		--		Up to 70		--										
Rated operational voltage U_e acc. to IEC	V	690 AC ²⁾		690 AC ²⁾		690 AC ²⁾		690 AC ²⁾		690 AC		690 AC									
Rated frequency	Hz	50/60		50/60		50/60		50/60		50/60		50/60									
Trip class		CLASS 10 (S00 ... S3), CLASS 20 (S2, S3)		CLASS 10		--		CLASS 10		--		--									
Thermal overload releases	A	0.11 ... 0.16 to 80 ... 100		0.11 ... 0.16 to 80 ... 100		None ³⁾		0.11 ... 0.16 to 54 ... 65		0.16 ... 70 Non-adjustable		0.16 ... 22 Non-adjustable									
Electronic releases	A	13 times		13 times		13 times		20 times		13 times		20 times									
Short-circuit breaking capacity I_{cu} at 400 V AC	kA	20/55/65/100		55/65/100		20/55/65/100		55/65/100		4)		4)									
Pages		7/26 ... 7/28		7/30		7/32, 7/33		7/34		7/35		7/36									
Accessories																					
For sizes		S00	S0	S2	S3	S00	S0	S2	S3	S00	S0	S2	S3	S00	S0	S2	S00	S0	S3	S00	S0
Auxiliary switches	✓	✓	✓	✓	✓	✓	✓	✓	✓	✓	✓	✓	✓	✓	✓	✓	✓	✓	✓	✓	✓
Signaling switches	✓	✓	✓	✓	✓	✓	✓	✓	✓	✓	✓	✓	✓	✓	✓	✓	--	--	--	--	--
Undervoltage releases	✓	✓	✓	✓	--	--	--	--	✓	✓	✓	✓	✓	✓	✓	✓	✓	✓	✓	✓	✓
Shunt releases	✓	✓	✓	✓	--	--	--	--	✓	✓	✓	✓	✓	✓	✓	✓	✓	✓	✓	✓	✓
Isolator modules	✓	✓	✓	--	✓	✓	✓	--	✓	✓	✓	✓	--	✓	✓	✓	--	--	--	--	--
Insulated three-phase busbar system	✓	✓	✓	--	--	--	--	--	✓	✓	✓	✓	--	✓	✓	✓	--	--	--	--	--
Busbar adapters	✓	✓	✓	✓	✓	✓	✓	✓	✓	✓	✓	✓	✓	✓	✓	✓	✓	✓	✓	--	--
Door-coupling rotary operating mechanisms	✓	✓	✓	✓	✓	✓	✓	✓	✓	✓	✓	✓	✓	✓	✓	✓	✓	✓	✓	✓	✓
Link modules	✓	✓	✓	✓	✓	✓	✓	✓	✓	✓	✓	✓	✓	✓	✓	✓	--	--	--	--	--
Enclosures for surface mounting	✓	✓	✓	--	✓	✓	✓	--	✓	✓	✓	✓	--	✓	✓	✓	--	--	--	--	--
Enclosures for flush mounting	✓	✓	--	--	✓	✓	--	--	✓	✓	--	--	✓	✓	--	--	--	--	--	--	--
Front plates	✓	✓	✓	✓	✓	✓	✓	✓	✓	✓	✓	✓	✓	✓	✓	✓	--	--	--	--	--
Infeed system	✓	✓	--	--	--	--	--	--	✓	✓	--	--	✓	✓	--	--	--	--	--	--	--
Sealable scale covers for setting knobs	✓	✓	✓	✓	✓	✓	✓	✓	✓	--	--	--	✓	✓	✓	✓	--	--	--	--	--
Remote motorized operating mechanisms	--	--	--	✓	--	--	--	✓	--	--	--	✓	--	--	--	--	--	--	--	--	--
Pages		7/37 ... 7/59																			

✓ Has this function or can use this accessory
 -- Does not have this function or cannot use this accessory

- 1) For symmetrical loading of the three phases.
- 2) With molded-plastic enclosure 500 V AC. For DC applications, see "Technical Specifications" → "DC Short-Circuit Breaking Capacity", page 7/17.
- 3) For overload protection of the motors, appropriate overload relays must be used.
- 4) According to UL 489 at 480 Y/277 V AC: 65 kA or 50 kA.

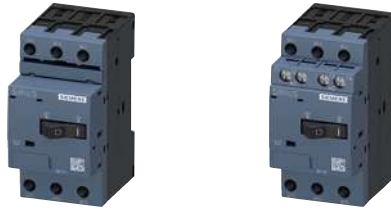

Type	3RV1611-0BD10	3RV1611-1.G14
SIRIUS 3RV1 motor starter protectors/circuit breakers		
Applications		
• System protection	--	--
• Motor protection	--	--
• Motor protection with overload relay function	--	--
• Starter combinations	--	--
• Transformer protection	--	--
• Fuse monitoring	✓	--
• Voltage transformer circuit breakers for distance protection	--	✓
Size	S00	S00
Rated current I_n		
• Size S00	0.2	Up to 3
Rated operational voltage U_e acc. to IEC	690 AC ¹⁾	400 AC
Rated frequency	50/60	16 ² /3 ... 60
Trip class	--	--
Thermal overload releases	0.2	1.4 ... 3
Electronic releases A multiple of the rated current	6 times	4 ... 7 times
Short-circuit breaking capacity I_{cu} at 400 V AC	100	50
Pages	7/60	7/61
Accessories		
For sizes	S00	S00
Pages	7/60, 7/61	

- ✓ Has this function or can use this accessory
 -- Does not have this function or cannot use this accessory

¹⁾ With molded-plastic enclosure 500 V AC. For DC applications, see "Technical Specifications" → "DC Short-Circuit Breaking Capacity", page 7/18.

Protection Equipment

Introduction



Type	3RV10				3RV13					
SIRIUS 3RV1 molded case motor starter protectors										
Applications										
• Motor protection	✓				--					
• Starter combinations	--				✓					
Switching capacity	Standard switching capacity				Standard switching capacity					Increased switching capacity
Type	3RV1063	3RV1073	3RV1083	3RV1353	3RV1363	3RV1373	3RV1383	3RV1364	3RV1374	
Rated current I_n	A 100 ... 200	400	630	1 ... 32	100 ... 250	400, 630	630, 800	100 ... 250	400	
Rated operational voltage U_e acc. to IEC	V 690 AC				690 AC					
Rated frequency	Hz 50/60				50/60					
Trip class	CLASS 10A, 10, 20, 30				-- ¹⁾					
Thermal overload releases	A 40 ... 100 to A 252 ... 630				Without ¹⁾					
Electronic releases A multiple of the rated current	Adjustable, 6 ... 13 times				Non-adjustable 1 ... 12.5 A: 13 times; Adjustable 20 A, 32 A: 6 ... 12 times		1 ... 10 times			
Short-circuit breaking capacity I_{cu} at 400 V AC	kA 120	120	100	85	120	120	100	200	200	
Trip unit (release)	TU 4				TU 1: 1 ... 12.5 A; TU 2: 20 A, 32 A		TU 3			
Pages	7/67				7/68					
Accessories										
For molded case motor starter protectors	3RV1063	3RV1073	3RV1083	3RV1353	3RV1363	3RV1373	3RV1383	3RV1364	3RV1374	
Auxiliary switches	✓	✓	✓	✓	✓	✓	✓	✓	✓	
Undervoltage releases	✓	✓	✓	✓	✓	✓	✓	✓	✓	
Shunt releases	✓	✓	✓	✓	✓	✓	✓	✓	✓	
Rotary operating mechanisms	✓	✓	✓	✓	✓	✓	✓	✓	✓	
Connection methods										
• Extended terminals on the front	✓	✓	--	✓	✓	✓	--	✓	✓	
• Cable terminals on the front	✓	✓	✓	✓	✓	✓	✓	✓	✓	
• Rear terminals	✓	✓	✓	✓	✓	✓	✓	✓	✓	
Pages	7/69, 7/70									

✓ Has this function or can use this accessory

-- Does not have this function or cannot use this accessory

¹⁾ For overload protection of the motors, appropriate overload relays must be used.

**Thermal overload relays
for standard applications**
**Electronic overload relays
for standard applications**

3RU21

3RB30

3RB31

Type

SIRIUS overload relays**Applications**

• System protection	✓ ¹⁾	✓ ¹⁾	✓ ¹⁾
• Motor protection	✓	✓	✓
• Alternating current, three-phase	✓	✓	✓
• Alternating current, single-phase	✓	--	--
• Direct current	✓	--	--

Size contactor	S00, S0, S2, S3	S00, S0, S2, S3	S00, S0, S2, S3
-----------------------	-----------------	-----------------	-----------------

Rated operational current I_e

• Size S00	A	Up to 16	Up to 16	Up to 16
• Size S0	A	Up to 40	Up to 40	Up to 40
• Size S2	A	Up to 80	Up to 80	Up to 80
• Size S3	A	Up to 100	Up to 115	Up to 115

Rated operational voltage U_e	V	690 AC	690 AC	690 AC
---	---	--------	--------	--------

Rated frequency	Hz	50/60	50/60	50/60
------------------------	----	-------	-------	-------

Trip class		CLASS 10, 10A	CLASS 10E, 20E	CLASS 5E, 10E, 20E, 30E (adjustable)
-------------------	--	---------------	----------------	--------------------------------------

Thermal overload releases	A	0.11 ... 0.16 to	--	--
	A	80 ... 100		

Electronic overload releases	A	--	0.1 ... 0.4 to	0.1 ... 0.4 to
	A	--	32 ... 115	32 ... 115

Pages	7/84 ... 7/87	7/97, 7/98	7/99
--------------	---------------	------------	------

Accessories

For sizes	S00	S0	S2	S3	S00	S0	S2	S3	S00	S0	S2	S3
Terminal supports for stand-alone installation	✓	✓	✓	✓	✓	✓	✓	✓	✓	✓	✓	✓
Mechanical RESET	✓	✓	✓	✓	✓	✓	✓	✓	✓	✓	✓	✓
Cable releases for RESET	✓	✓	✓	✓	✓	✓	✓	✓	✓	✓	✓	✓
Electrical remote RESET	✓	✓	✓	✓	--	--	--	--	Integrated in the unit			
Terminal covers												
• For box terminals	--	--	✓	✓	--	--	✓	✓	--	--	✓	✓
Sealable covers for setting knobs	✓	✓	✓	✓	✓	✓	✓	✓	✓	✓	✓	✓
Pages	7/88, 7/89				7/100, 7/101				7/100, 7/101			

✓ Has this function or can use this accessory

-- Does not have this function or cannot use this accessory

¹⁾ The units are responsible in the main circuit for overload protection of the assigned electrical loads (e.g. motors), feeder cable, and other switching and protection devices in the respective load feeder.

Protection Equipment

Introduction



Type	Electronic overload relays									
	For standard applications		For high-feature applications							
	3RB20	3RB21	3RB22, 3RB23	3RB24						
SIRIUS overload relays										
Applications										
• System protection	✓ ¹⁾	✓ ¹⁾	✓ ¹⁾							
• Motor protection	✓	✓	✓							
• Alternating current, three-phase	✓	✓	✓							
• Alternating current, single-phase	--	--	✓							
• Direct current	--	--	--							
Size contactor	S3 ... S12	S3 ... S12	S00 ... S12							
Rated operational current I_e										
• Sizes S00 and S0	--	--	Up to 25 and 45 mm width with current measuring modules 3RB2906-2BG1/3RB2906-2DG1							
• Size S2	--	--	Up to 100 and 55 mm width with current measuring module 3RB2906-2JG1							
• Size S3	--	--	Up to 200 and 120 mm width with current measuring modules 3RB2956-2TH2/3RB2956-2TG2							
• Size S6	Up to 200	Up to 200	Up to 630 and 145 mm width with current measuring module 3RB2966-2WH2							
• Size S10/S12	Up to 630	Up to 630	Up to 820 with current measuring module 3RB2906-2BG1 and transformer 3UF1868-3GA00							
• Size 14 (3TF68/3TF69)	Up to 630	Up to 630								
Rated operational voltage U_e	690/1 000 AC	690/1 000 AC	690/1 000 AC ²⁾							
Rated frequency	50/60	50/60	50/60							
Trip class	CLASS 10, 20	CLASS 5, 10, 20, 30 adjustable	CLASS 5, 10, 20, 30 adjustable							
Thermal overload releases	--	--	--							
Electronic overload releases	50 ... 200 to 160 ... 630	50 ... 200 to 160 ... 630	0.3 ... 3 to 63 ... 630							
Pages	7/109, 7/110	7/111	7/120, 7/121, 7/132	7/128, 7/132						
Accessories										
For sizes	S6	S10/S12	S6	S10/S12	S00	S0	S2	S3	S6	S10/S12
Terminal supports for stand-alone installation	3)	3)	3)	3)	3)	3)	3)	3)	3)	3)
Mechanical RESET	✓	✓	✓	✓	--	--	--	--	--	--
Cable releases for RESET	✓	✓	✓	✓	--	--	--	--	--	--
Electrical remote RESET	--	--	Integrated in the unit		Integrated in the unit					
Terminal covers	✓	✓	✓	✓	--	--	--	✓	✓	✓
Sealable covers for setting knobs	✓	✓	✓	✓	✓	✓	✓	✓	✓	✓
Operator panel for 3RB24 evaluation module	--	--	--	--	✓	✓	✓	✓	✓	✓
Pages	7/112, 7/113		7/112, 7/113		7/132 ... 7/134					

✓ Has this function or can use this accessory
 -- Does not have this function or cannot use this accessory

¹⁾ The units are responsible in the main circuit for overload protection of the assigned electrical loads (e.g. motors), feeder cable, and other switching and protection devices in the respective load feeder.

²⁾ With reference to the 3RB29.6 current measuring modules.

³⁾ Stand-alone installation without accessories is possible.

Motor Starter Protectors/Circuit Breakers

SIRIUS 3RV2 Motor Starter Protectors/Circuit Breakers

General data

Overview

More information

Home page, see www.siemens.com/sirius-circuit-breaker
 Industry Mall, see www.siemens.com/product?3RV2
 Conversion tool, e.g. from 3RV1 to 3RV2, see www.siemens.com/sirius/conversion-tool

Application Manual "SIRIUS Controls with IE3/IE4 Motors", see <https://support.industry.siemens.com/cs/ww/en/view/94770820>
 System Manual "SIRIUS – System Overview", see <https://support.industry.siemens.com/cs/ww/en/view/60311318>
 Manual "SIRIUS – SIRIUS 3RV2 Motor Starter Protectors", see <https://support.industry.siemens.com/cs/ww/en/view/60279172>
 Certificates, see <https://support.industry.siemens.com/cs/ww/en/ps/16245/cert>

The following illustration shows 3RV2 motor starter protectors/circuit breakers with the accessories which can be mounted for the sizes S00 to S3, see also "Introduction" → "Overview", page 7/2.

Accessories, see page 7/37 onwards.

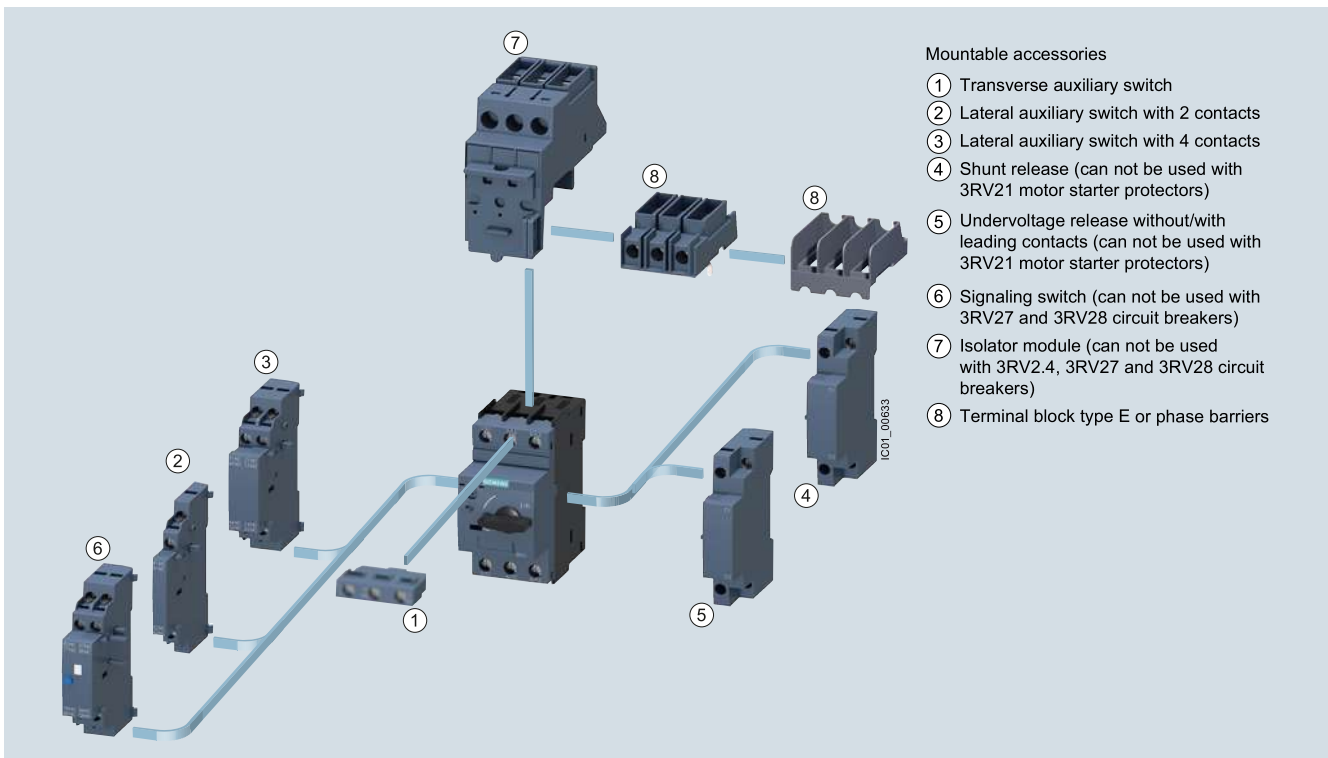

Mountable accessories for SIRIUS 3RV2 motor starter protectors/circuit breakers



SIRIUS motor starter protector with spring-type terminals, size S0 (left) and SIRIUS motor starter protector with screw terminals, size S00 (right)

The SIRIUS 3RV2 motor starter protectors/circuit breakers are compact, current limiting motor starter protectors/circuit breakers which are optimized for load feeders. The motor starter protectors/circuit breakers are used for switching and protecting three-phase motors of up to 55/45 kW at 400 V AC and for other loads with rated currents of up to 100 A.

The new 3RV2 motor starter protectors/circuit breakers are usually approved according to IEC and UL/CSA. According to UL 508/UL 60947-4-1, the 3RV2 motor starter protectors/circuit breakers in sizes S00 to S3 are approved as:

- "Manual Motor Controllers"
- "Manual Motor Controllers" for "Group Installations"
- "Manual Motor Controllers Suitable for Tab Conductor Protection in Group Installations"
- "Self-Protected Combination Motor Controllers (Type E)"
Please note that for this approval the 3RV20 motor starter protectors must be equipped with additional infeed terminals or phase barriers. For more information, see "Accessories" on page 7/45.

Corresponding short-circuit values, see pages 7/10 to 7/16.

The 3RV27 and 3RV28 are approved as circuit breakers according to UL 489; they are a special version of the 3RV2 motor starter protectors.

Motor Starter Protectors/Circuit Breakers

SIRIUS 3RV2 Motor Starter Protectors/Circuit Breakers

General data

Type of construction

The 3RV2 motor starter protectors are available in four sizes:

- Size S00 – width 45 mm, max. rated current 16 A, at 400 V AC suitable for three-phase motors up to 7.5 kW
- Size S0 – width 45 mm, max. rated current 40 A, at 400 V AC suitable for three-phase motors up to 18.5 kW
- Size S2 – width 55 mm, max. rated current 80 A, at 400 V AC suitable for three-phase motors up to 37 kW
- Size S3 – width 70 mm, max. rated current 100 A, at 400 V AC suitable for three-phase motors up to 45/55 kW

Circuit breakers acc. to UL 489

The 3RV27 and 3RV28 circuit breakers are available in two or three sizes:

- Size S00 – width 45 mm, max. rated current 15 A, at 480 Y/277 V AC
- Size S0 – width 45 mm, max. rated current 22 A, at 480 Y/277 V AC
- Size S3 – width 70 mm, max. rated current 70 A, at 480 Y/277 V AC

Connection methods

The 3RV2 motor starter protectors/circuit breakers can be supplied with screw terminals and spring-type terminals.



Screw terminals



Spring-type terminals

The terminals are indicated in the corresponding tables by the symbols shown on orange backgrounds.

Use in hazardous areas

The 3RV20 motor starter protectors for motor protection in sizes S00 and S0 have certification in accordance with both the European explosion protection directive ATEX and the international explosion protection standard (IECEx). Size S3 available on request.

In accordance with the European directive (ATEX), the 3RV20 are able to switch and protect explosion-proof motors of type of protection "Increased Safety EEx e".

In accordance with the international guideline (IECEx), the 3RV20 are able to switch and protect motors of the types "Increased Safety Ex e" or "Flameproof enclosure Ex d"

Article No. scheme

Product versions	Article number
Motor starter protectors/circuit breakers	3RV2 □ □ □ - □ □ □ □ □ - □ □ □ □
Type of motor starter protector/circuit breaker	e. g. 0 = for motor protection/system protection □
Size	e. g. 1 = 16 A (7.5 kW) for size S00 □
Breaking capacity	e. g. 1 = standard switching capacity □
Setting range for overload release	e. g. 1A = 1.1 ... 1.6 A □ □
Trip class (CLASS)	e. g. A = a (adjustable CLASS 10) / n (13 or 20 x I _n) □
Connection methods	e. g. 1 = screw terminals □
With or without auxiliary switch	e. g. 0 = without □
Special versions	□ □ □ □
Example	3RV2 0 1 1 - 1 A A 1 0

Note:

The Article No. scheme shows an overview of product versions for better understanding of the logic behind the article numbers.

For your orders please use the article numbers quoted in the selection and ordering data.

Motor Starter Protectors/Circuit Breakers

SIRIUS 3RV2 Motor Starter Protectors/Circuit Breakers

General data

Benefits

Advantages through energy efficiency

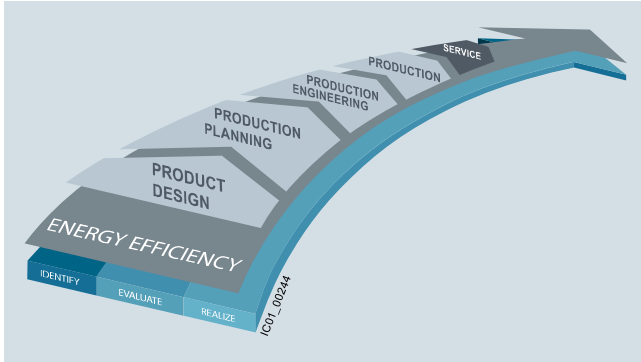

Overview of the energy management process

We offer you a unique portfolio for industrial energy management, using an energy management system that helps to optimally define your energy needs. We split up our industrial energy management into three phases – identify, evaluate, and realize – and we support you with the appropriate hardware and software solutions in every process phase.

The innovative products of the SIRIUS industrial controls portfolio can also make a substantial contribution to a plant's energy efficiency (see www.siemens.com/sirius/energysaving).

3RV2 motor starter protectors/circuit breaker contribute to energy efficiency throughout the plant as follows:

- Minimization of energy losses through optimization of the bimetal trip units
- Reduction of inherent power loss
- Less heating of the control cabinet
- Smaller control cabinet air conditioners can be used

Application

Operating conditions

3RV2 motor starter protectors/circuit breakers are suitable for use in any climate. They are intended for use in enclosed rooms in which no severe operating conditions (such as dust, caustic vapors, hazardous gases) prevail. When installed in dusty and damp areas, suitable enclosures must be provided.

3RV2 motor starter protectors/circuit breakers can optionally be fed from the top or from below.

The permissible ambient temperatures, the maximum switching capacities, the tripping currents and other boundary conditions can be found in the technical specifications and tripping characteristics, see [Manual](#).

3RV2 motor starter protectors/circuit breakers are suitable for operation in IT systems (IT networks). In this case, the different short-circuit breaking capacity in the IT system must be taken into account, see [page 7/12](#).

Since operational currents, starting currents and current peaks are different even for motors with identical power ratings due to the inrush current, the motor ratings in the selection tables are only guide values. The specific rated and startup data of the motor to be protected is always paramount to the choice of the most suitable motor starter protector/circuit breaker. This also applies to motor starter protectors for transformer protection.

Possible uses

The 3RV motor starter protectors/circuit breakers can be used:

- For short-circuit protection
- For motor protection (also with overload relay function)
- For system protection
- For short-circuit protection for starter combinations
- For transformer protection
- As main and EMERGENCY-STOP switches
- For operation in IT systems (IT networks)
- For switching of DC currents
- In areas subject to explosion hazard (ATEX)
- As circuit breakers according to UL 489 (3RV27 and 3RV28)
- For fuse monitoring
- For distance protection

Use of SIRIUS protection devices in conjunction with IE3/IE4 motors

Note:

For the use of 3RV2 motor starter protectors/circuit breakers in conjunction with highly energy-efficient IE3/IE4 motors, please observe the information on dimensioning and configuring, see [Application Manual](#).

For more information, see [Preface on page 7](#).

Motor Starter Protectors/Circuit Breakers

SIRIUS 3RV2 Motor Starter Protectors/Circuit Breakers

General data

Technical specifications

More information

System Manual "SIRIUS – System Overview", see <https://support.industry.siemens.com/cs/ww/en/view/60311318>

Configuration manual "Configuring SIRIUS Innovations – Selection Data for Fuseless and Fused Load Feeders", see <https://support.industry.siemens.com/cs/ww/en/view/39714188>

Manual "SIRIUS – SIRIUS 3RV2 Motor Starter Protectors", see <https://support.industry.siemens.com/cs/ww/en/view/60279172>

Technical specifications, see

<https://support.industry.siemens.com/cs/ww/en/ps/16245/td>

UL reports of the individual devices, see www.siemens.com/sirius/manuals

Short-circuit breaking capacity I_{CU} , I_{CS} according to IEC 60947-2

The table shows the rated ultimate short-circuit breaking capacity I_{CU} and the rated service short-circuit breaking capacity I_{CS} of the 3RV2 motor starter protectors/circuit breakers with different operating voltages dependent on the rated current I_n of the motor starter protectors/circuit breakers.

Power can be supplied to the motor starter protectors/circuit breakers via the terminals at the top or at the bottom without restricting the rated data. If the short-circuit current at the place of installation exceeds the rated short-circuit breaking capacity of the motor starter protector/circuit breaker as specified in the table, a back-up fuse is required. It is also possible to install an

upstream motor starter protector/circuit breaker with a limiter function.

The maximum rated current of this back-up fuse is indicated in the tables. The rated ultimate short-circuit breaking capacity then applies as specified on the fuse.

Fuseless design

Motor starter protector/contactors assemblies for short-circuit currents up to 150 kA can be ordered as 3RA2 fuseless load feeders, see page 8/4 onwards.

Motor starter protectors / circuit breakers	Rated current I_n	Up to 240 V AC ¹⁾			Up to 400 V AC ¹⁾ / 415 V AC ²⁾			Up to 440 V AC ¹⁾ / 460 V AC ²⁾			Up to 500 V AC ¹⁾ / 525 V AC ²⁾			Up to 690 V AC ¹⁾		
		I_{CU}	I_{CS}	Max. fuse (gG)	I_{CU}	I_{CS}	Max. fuse (gG) ³⁾	I_{CU}	I_{CS}	Max. fuse (gG) ³⁾	I_{CU}	I_{CS}	Max. fuse (gG) ³⁾	I_{CU}	I_{CS}	Max. fuse (gG) ³⁾⁴⁾
Type	A	kA	kA	A	kA	kA	A	kA	kA	A	kA	kA	A	kA	kA	A
Size S00																
3RV2.11	0.16 ... 1.6	100	100	--	100	100	--	100	100	--	100	100	--	100	100	--
	2; 2.5	100	100	--	100	100	--	100	100	--	100	100	--	10	10	25
	3.2	100	100	--	100	100	--	100	100	--	100	100	--	10	10	32
	4; 5	100	100	--	100	100	--	100	100	--	100	100	--	6	4	32
	6.3	100	100	--	100	100	--	100	100	--	100	100	--	6	4	50
	8	100	100	--	100	100	--	50	50	63	42	42	63	6	4	50
	10	100	100	--	100	100	--	50	50	80	42	42	63	6	4	50
	12.5	100	100	--	100	100	--	50	50	80	42	42	80	6	4	63
	16	100	100	--	55	30	100	50	12.5	80	10	5	80	4	4	63
3RV1611-0BD10	0.2	100	100	--	100	100	--	100	100	--	100	100	--	100	100	--
Size S0																
3RV2.21	0.16 ... 1.6	100	100	--	100	100	--	100	100	--	100	100	--	100	100	--
	2; 2.5	100	100	--	100	100	--	100	100	--	100	100	--	10	10	25
	3.2	100	100	--	100	100	--	100	100	--	100	100	--	10	10	32
	4; 5	100	100	--	100	100	--	100	100	--	100	100	--	6	4	32
	6.3	100	100	--	100	100	--	100	100	--	100	100	--	6	4	50
	8	100	100	--	100	100	--	50	50	63	42	42	63	6	4	50
	10	100	100	--	100	100	--	50	50	80	42	42	63	6	4	50
	12.5	100	100	--	100	100	--	50	50	80	42	42	80	6	4	63
	16	100	100	--	55	25	100	50	12.5	80	10	5	80	4	2	63
	20	100	100	--	55	25	125	50	10	80	10	5	80	4	2	63
	22; 25	100	100	--	55	25	125	50	10	100	10	5	80	4	2	63
	28; 32	100	100	--	55	25	125	30	10	125	10	5	100	4	2	100
	36; 40	100	100	--	20	10	125	12	8	125	6	3	100	3	2	100

-- No back-up fuse required, since short-circuit resistant up to 100 kA

1) 10 % overvoltage.

2) 5 % overvoltage.

3) Back-up fuse only required if short-circuit current at the place of installation is $> I_{CU}$.

4) Alternatively, fuseless limiter combinations for 690 V AC can also be used.

Motor Starter Protectors/Circuit Breakers

SIRIUS 3RV2 Motor Starter Protectors/Circuit Breakers

General data

Motor starter protectors/ circuit breakers	Rated current I_n	Up to 240 V AC ¹⁾			Up to 400 V AC ^{1)/} 415 V AC ²⁾			Up to 440 V AC ^{1)/} 460 V AC ²⁾			Up to 500 V AC ^{1)/} 525 V AC ²⁾			Up to 690 V AC ¹⁾		
		I_{cu}	I_{cs}	Max. fuse (gG)	I_{cu}	I_{cs}	Max. fuse (gG) ³⁾	I_{cu}	I_{cs}	Max. fuse (gG) ³⁾	I_{cu}	I_{cs}	Max. fuse (gG) ³⁾	I_{cu}	I_{cs}	Max. fuse (gG) ³⁾⁴⁾
Type	A	kA	kA	A	kA	kA	A	kA	kA	A	kA	kA	A	kA	kA	A
Size S2																
3RV2.31	14; 17	100	100	--	65	30	100	50	25	100	12	6	63	5	3	63
	20	100	100	--	65	30	100	50	25	100	12	6	80	5	3	80
	25	100	100	--	65	30	100	50	15	100	12	6	80	5	3	80
	32; 36	100	100	--	65	30	125	50	15	125	10	5	100	4	2	100
	40; 45	100	100	--	65	30	160	50	15	125	10	5	100	4	2	100
	52	100	100	--	65	30	160	50	15	125	10	5	125	4	2	125
	59; 65	100	100	--	65	30	160	50	15	160	8	4	125	4	2	125
	73; 80	100	100	--	65	30	200	50	15	200	8	4	160	4	2	125
Size S2, with increased switching capacity																
3RV2.32	14; 17	100	100	--	100	50	--	65	30	100	18	10	63	8	5	63
	20; 25	100	100	--	100	50	--	65	30	100	18	10	80	8	5	80
	32 ... 45	100	100	--	100	50	--	65	30	125	15	8	100	6	4	100
	52	100	100	--	100	50	--	65	30	125	15	8	125	6	4	125
	59; 65	100	100	--	100	50	--	50	15	160	10	5	125	6	4	125
	73; 80	100	100	--	100	50	--	50	15	200	10	5	160	6	4	125
Size S3																
3RV2.41	40 ... 100	On request														
Size S3, with increased switching capacity																
3RV2.42/ 3RV2742⁵⁾	40 ... 100	On request														

-- No back-up fuse required, since short-circuit resistant up to 100 kA

1) 10 % overvoltage.

2) 5 % overvoltage.

3) Back-up fuse only required if short-circuit current at the place of installation is $> I_{cu}$.

4) Alternatively, fuseless limiter combinations for 690 V AC can also be used.

5) The values for the 3RV2742 circuit breakers have been tested only up to 400 V/415 V AC.

Motor Starter Protectors/Circuit Breakers

SIRIUS 3RV2 Motor Starter Protectors/Circuit Breakers

General data

Short-circuit breaking capacity I_{cuIT} in the IT system (IT network) according to IEC 60947-2

3RV2 motor starter protectors/circuit breakers are suitable for use in IT systems. The values of I_{cu} and I_{cs} apply for the three-pole short circuit. In the case of a double ground fault in different phases at the input and output side of a motor starter protector/circuit breaker, the special short-circuit breaking capacity I_{cuIT} applies. The specifications in the table below apply to 3RV2 motor starter protectors/circuit breakers.

If the short-circuit current at the place of installation exceeds the motor starter protector/circuit breaker's specified rated short-circuit breaking capacity, you will need to use a back-up fuse. The maximum rated current of this back-up fuse is indicated in the tables. The rated short-circuit breaking capacity then applies as specified on the fuse.

Motor starter protectors/ circuit breakers	Rated current I_n A	Up to 240 V AC ¹⁾		Up to 400 V AC ^{1)/} 415 V AC ²⁾		Up to 440 V AC ^{1)/} 460 V AC ²⁾		Up to 500 V AC ^{1)/} 525 V AC ²⁾		Up to 690 V AC ¹⁾⁵⁾	
		I_{cuIT} kA	Max. fuse (gG) ³⁾ A	I_{cuIT} kA	Max. fuse (gG) ³⁾⁴⁾ A	I_{cuIT} kA	Max. fuse (gG) ³⁾ A	I_{cuIT} kA	Max. fuse (gG) ³⁾ A	I_{cuIT} kA	Max. fuse (gG) ³⁾ A
Size S00											
3RV2.11	0.16 ... 0.4	100	--	100	--	100	--	100	--	100	--
	0.5	100	--	100	--	100	--	100	--	0.5	4
	0.63; 0.8	100	--	100	--	100	--	100	--	0.5	6
	1	100	--	100	--	2	10	2	10	1.5	10
	1.25	100	--	100	--	2	16	2	16	1.5	16
	1.6	100	--	100	--	2	20	2	20	1.5	16
	2; 2.5	100	--	8	25	2	25	2	25	1.5	20
	3.2	100	--	8	32	2	32	2	32	1.5	25
	4; 5	100	--	4	32	1.5	32	1.5	32	1.5	25
	6.3; 8	100	--	4	50	1	40	1	40	1	35
	10	100	--	4	50	1	40	1	40	1	40
	12.5	100	--	4	63	1	50	1	50	1	40
	16	55	80	4	63	1	50	1	50	1	40
3RV1611-0BD10	0.2	100	--	100	--	--	--	100	--	100	--
Size S0											
3RV2.21	0.16 ... 0.4	100	--	100	--	100	--	100	--	100	--
	0.5	100	--	100	--	100	--	100	--	0.5	4
	0.63; 0.8	100	--	100	--	100	--	100	--	0.5	6
	1	100	--	100	--	2	10	2	10	1.5	10
	1.25	100	--	100	--	2	16	2	16	1.5	16
	1.6	100	--	100	--	2	20	2	20	1.5	16
	2; 2.5	100	--	8	25	2	25	2	25	1.5	20
	3.2	100	--	8	32	2	32	2	32	1.5	25
	4; 5	100	--	4	32	1.5	32	1.5	32	1.5	25
	6.3; 8	100	--	4	50	1	40	1	40	1	35
	10	100	--	4	50	1	40	1	40	1	40
	12.5	100	--	4	63	1	50	1	50	1	40
	16	55	80	4	63	1	50	1	50	1	40
	20 ... 25	55	80	4	63	1	50	1	50	1	50
	28; 32	55	80	2	63	1	63	1	63	1	63
	36; 40	20	80	2	63	1	63	1	63	1	63

-- No back-up fuse required, since short-circuit resistant up to 100 kA

1) 5 % overvoltage.

2) Without overvoltage.

3) Back-up fuse only required if short-circuit current at installation location is $> I_{cuIT}$.

4) Alternatively, fuseless limiter combinations for 690 V AC can also be used.

5) Overvoltage category II applies for applications in IT systems > 600 V.

Motor Starter Protectors/Circuit Breakers

SIRIUS 3RV2 Motor Starter Protectors/Circuit Breakers

General data

Motor starter protectors/ circuit breakers	Rated current I_n	Up to 240 V AC ¹⁾		Up to 400 V AC ^{1)/} 415 V AC ²⁾		Up to 440 V AC ^{1)/} 460 V AC ²⁾		Up to 500 V AC ^{1)/} 525 V AC ²⁾		Up to 690 V AC ¹⁾⁵⁾	
		I_{cuIT}	Max. fuse (gG) ³⁾	I_{cuIT}	Max. fuse (gG) ³⁾⁴⁾	I_{cuIT}	Max. fuse (gG) ³⁾	I_{cuIT}	Max. fuse (gG) ³⁾	I_{cuIT}	Max. fuse (gG) ³⁾
Type	A	kA	A	kA	A	kA	A	kA	A	kA	A
Size S2											
3RV2031, 3RV2131, 3RV2331	14 ... 25	100	--	8	100	6	80	6	80	4	63
	32 ... 45	100	--	6	125	4	100	4	100	3	80
	52 ... 80	100	--	4	160	3	125	3	125	2	100
Size S2, with increased switching capacity											
3RV2032, 3RV2332	14 ... 25	100	--	8	100	6	80	6	80	4	63
	32 ... 45	100	--	6	125	6	100	6	100	4	80
	52	100	--	6	160	6	125	6	125	4	100
	59 ... 80	100	--	6	160	4	125	4	125	4	100
Size S3											
3RV2.41	40 ... 100	On request									
Size S3, with increased switching capacity											
3RV2.42	40 ... 100	On request									

-- No back-up fuse required, since short-circuit resistant up to 100 kA

1) 10 % overvoltage.

2) 5 % overvoltage.

3) Back-up fuse only required if short-circuit current at installation location is $> I_{cuIT}$.

4) Alternatively, fuseless limiter combinations for 690 V AC can also be used.

5) Overvoltage category II applies for applications in IT systems > 600 V.

Limiting function with standard devices for 500 V AC and 690 V AC according to IEC 60947-2

The table shows the rated ultimate short-circuit breaking capacity I_{cu} and the rated service short-circuit breaking capacity I_{cs} with an upstream standard motor starter protector/circuit breaker that fulfills the limiter function at voltages 500 V AC and 690 V AC.

The short-circuit breaking capacity can be increased significantly with an upstream standard motor starter protector/circuit breaker with limiter function. The motor starter protector/circuit

breaker which is connected downstream must be set to the rated current of the load.

With motor starter protector/circuit breaker assemblies, note the clearance to grounded parts and between the motor starter protectors/circuit breaker. Short-circuit proof wiring between the motor starter protectors/circuit breaker must be ensured. The motor starter protectors/circuit breakers can be mounted side by side in a modular arrangement.

Standard motor starter protectors/circuit breakers	Rated current I_n	Up to 500 V AC ^{1)/} 525 V AC ²⁾		Up to 690 V AC ¹⁾		
		I_{cu} kA	I_{cs} kA	I_{cu} kA	I_{cs} kA	
Type	A					
Size S00						
3RV2011	Size S0: 3RV2321-4EC10 $I_n = 32$ A	2 ... 6.3 8 10 ... 16	-- 100 100	-- 50 50	50 20 20 ³⁾	25 10 10 ³⁾
	Size S2: 3RV2331-4WC10 $I_n = 52$ A	10 ... 16	--	--	50	25
Size S0						
3RV2021	Size S0: 3RV2321-4EC10 $I_n = 32$ A	16 ... 32	100	50	20 ³⁾	10 ³⁾
	Size S2: 3RV2331-4WC10 $I_n = 52$ A	16 ... 32	--	--	50	20
Size S2, with increased switching capacity						
3RV2032	Size S2: 3RV2332-4RC10 $I_n = 80$ A	14 ... 80	100	50	70	35
Size S3, with increased switching capacity						
3RV2042		40 ... 100	On request			

-- No limiter required

1) 10 % overvoltage.

2) 5 % overvoltage.

3) Infeed to the limiter is always on the side 1L1/3L2/5L3.

Motor Starter Protectors/Circuit Breakers

SIRIUS 3RV2 Motor Starter Protectors/Circuit Breakers

General data

Permissible rated data of devices approved for North America (UL/CSA)

Motor starter protectors of the 3RV2 series are approved for UL/CSA, and according to UL 508/UL 60947-4-1 and CSA C22.2 No. 14/CSA C22.2 No. 60947-4-1 they can be used on their own or as load feeders in combination with a contactor.

These motor starter protectors/circuit breakers can be used as "Manual Motor Controllers" for "Group Installations", as "Manual Motor Controllers Suitable for Tap Conductor Protection in Group Installations" and as "Self-Protected Combination Motor Controllers" (Type E).

3RV2 motor starter protectors as "Manual Motor Controllers"

If used as a "Manual Motor Controller", the motor starter protector is always operated in combination with an upstream short-circuit protection device. Approved fuses or a circuit breaker according to UL 489/CSA C22.2 No. 5 may be used for this purpose. These devices must be dimensioned according to the National Electrical Code (UL) or Canadian Electrical Code (CSA).

The file numbers for the approval of the 3RV2 as a Manual Motor Controller are as follows:

- UL File No. 47705, CCN: NLRV
- CSA Master Contract 165071, Product Class: 3211

Motor starter protectors/ circuit breakers		hp rating ¹⁾ for FLA ²⁾ max.		Rated current I_n A	240 V AC		480 V AC		600 V AC	
		Single- phase	3-phase		UL $I_{bc}^{(3)}$ kA	CSA $I_{bc}^{(3)}$ kA	UL $I_{bc}^{(3)}$ kA	CSA $I_{bc}^{(3)}$ kA	UL $I_{bc}^{(3)}$ kA	CSA $I_{bc}^{(3)}$ kA
Type	V									
Size S00										
3RV2011, 3RV2111, 3RV2311, 3RV2411				0.16 ... 12.5 16	65 65	65 65	65 65	65 65	30 --	30 --
FLA ²⁾ max.	115	1	2							
16 A, 480 V	200	2	3							
12.5 A, 600 V	230	2	5							
	460	--	10							
	575/600	--	10							
3RV1611-0BD10				0.2	65	65	65	65	10	10
Size S0										
3RV2021, 3RV2121, 3RV2321, 3RV2421				0.16 ... 12.5 16 ... 25 28, 32 36, 40	65 65 65 65	65 65 65 65	65 65 50 12	65 65 50 12	30 -- -- --	30 -- -- --
FLA ²⁾ max.	115	3	5							
40 A, 480 V	200	5	10							
12.5 A, 600 V	230	7 1/2	10							
	460	--	30							
	575/600	--	--							
Size S2										
3RV2031, 3RV2331				14 ... 36 40 ... 52 59 ... 65 73 ... 80	65 65 65 65	65 65 65 65	65 65 65 ⁵⁾ 65 ⁵⁾	65 65 65 ⁵⁾ 65 ⁵⁾	25 22 20 ⁵⁾ 20 ⁵⁾	25 22 20 ⁵⁾ 20 ⁵⁾
FLA ²⁾ max.	115/120	7.5	10							
80 A, 600 V	200/208	15	25							
	230/240	15	30							
	460/480	--	60							
	575/600	--	75							
Size S2, with increased switching capacity										
3RV2032, 3RV2332				14 ... 36 40 ... 52 59 ... 65 73 ... 80	100 100 100 100	100 100 100 100	100 100 100 ⁵⁾ 100 ⁵⁾	100 100 100 ⁵⁾ 100 ⁵⁾	25 22 25 ⁵⁾ 25 ⁵⁾	25 22 25 ⁵⁾ 25 ⁵⁾
FLA ²⁾ max.	115/120	7.5	10							
80 A, 600 V	200/208	15	25							
	230/240	15	30							
	460/480	--	60							
	575/600	--	75							

Size S3 available on request

-- No approval

¹⁾ hp rating = Power rating in horse power (maximum motor rating).

²⁾ FLA = Full Load Amps/motor full load current.

³⁾ Corresponds to "short-circuit breaking capacity" according to UL/CSA.

⁴⁾ Values in brackets only apply to 3RV2.23 motor starter protectors.

⁵⁾ With Class J fuse.

Motor Starter Protectors/Circuit Breakers

SIRIUS 3RV2 Motor Starter Protectors/Circuit Breakers

General data

3RV20 motor starter protectors (up to 100 A) as "Manual Motor Controller Suitable for Tap Conductor Protection in Group Installations"

The application as "Manual Motor Controllers Suitable for Tap Conductor Protection in Group Installations" is only available for UL. CSA does not recognize this approval! When the motor starter protector is used as a "Manual Motor Controller Suitable for Tap Conductor Protection in Group Installations", it must always be combined with upstream short-circuit protection. Approved fuses or a circuit breaker according to UL 489 may be used for this purpose. These devices must be dimensioned according to the National Electrical Code.

The 3RV20 motor starter protectors are approved as "Manual Motor Controllers Suitable for Tap Conductor Protection in Group Installations" under the following file number:

- UL File No. 47705, CCN: NLRV

Motor starter protectors/ circuit breakers		hp rating ¹⁾ for FLA ²⁾ max.		Rated current I_n A	240 V AC	480 Y/277 V AC	600 Y/347 V AC
		Single- phase	3-phase		UL I_{bc} ³⁾ kA	UL I_{bc} ³⁾ kA	UL I_{bc} ³⁾ kA
Type	V						
Size S00							
3RV2011				0.16 ... 12.5 16	65 65	65 65	30 --
FLA ²⁾ max.	115	1	2				
16 A, 480 V	200	2	3				
12.5 A, 600 V	230	2	5				
	460	--	10				
	575/600	--	10				
Size S0							
3RV2021				0.16 ... 12.5 16 ... 25 28; 32	65 65 50	65 65 50	30 -- --
FLA ²⁾ max.	115	2	5				
32 A, 480 V	200	3	7.5				
12.5 A, 600 V	230	5	10				
	460	--	20				
	575/600	--	--				
Size S2							
3RV2031				14 ... 36 40 ... 52 59 ... 65	65 65 65 65 65	65 65 30 20 10	25 22 -- -- --
FLA ²⁾ max.	115/120	7.5	10				
80 A, 480 V	200/208	15	25				
52 A, 600 V	230/240	15	30				
	460/480	--	60				
	575/600	--	75				
Size S2, with increased switching capacity							
3RV2032				14 ... 36 40 ... 52 59 ... 65	100 100 100 100 100	100 100 42 30 10	25 22 -- -- --
FLA ²⁾ max.	115/120	7.5	10				
80 A, 480 V	200/208	15	25				
52 A, 600 V	230/240	15	30				
	460/480	--	60				
	575/600	--	75				
Size S3 available on request							

-- No approval

¹⁾ hp rating = Power rating in horse power (maximum motor rating).

²⁾ FLA = Full Load Amps/motor full load current.

³⁾ Corresponds to "short-circuit breaking capacity" according to UL.

Motor Starter Protectors/Circuit Breakers

SIRIUS 3RV2 Motor Starter Protectors/Circuit Breakers

General data

3RV20 motor starter protectors (up to 100 A) as "Self-Protected Combination Motor Controller (Type E)"

UL 508/UL 60947-4-1 approval demands 1-inch through air spacing and 2-inch over surface spacing at line side for "Self-Protected Combination Motor Controller Type E".

Therefore, 3RV20 motor starter protectors of sizes S00 to S3 are approved according to UL 508/UL 60947-4-1 in combination with the terminal blocks listed below.

CSA does not require these extended clearances. According to CSA, these terminal blocks can be omitted when the device is used as a "Self-Protected Combination Motor Controller".

The 3RV20 motor starter protectors are approved as "Self-Protected Combination Motor Controllers" under the following file numbers:

- UL File No. E156943, CCN: NKJH
- CSA Master Contract 165071, Product Class: 3211 08

Motor starter protectors/ circuit breakers		hp rating ¹⁾ for FLA ²⁾ max.		Rated current I_n A	Up to 240 V AC		Up to 480 Y/277 V AC		Up to 600 Y/347 V AC	
		Single- phase	3-phase		UL $I_{bc}^{(3)}$ kA	CSA $I_{bc}^{(3)}$ kA	UL $I_{bc}^{(3)}$ kA	CSA $I_{bc}^{(3)}$ kA	UL $I_{bc}^{(3)}$ kA	CSA $I_{bc}^{(3)}$ kA
Type	V									
Size S00										
3RV2011 + 3RV2928-1H⁴⁾⁵⁾				0.16 ... 12.5 16	65 65	65 65	65 65	65 65	30 --	30 --
FLA ²⁾ max.	115	1	2							
16 A, 480 V	200	2	3							
12.5 A, 600 V	230	2	5							
	460	--	10							
	575/600	--	10							
Size S0										
3RV2021 + 3RV2928-1H⁴⁾⁵⁾				0.16 ... 12.5 16 ... 25 28; 32	65 65 50	65 65 50	65 65 50	65 65 50	30 -- --	30 -- --
FLA ²⁾ max.	115	2	5							
32 A, 480 V	200	3	7.5							
12.5 A, 600 V	230	5	10							
	460	--	20							
	575/600	--	--							
Size S2										
3RV2031+ 3RV2938-1K4				14 ... 36 40 ... 52 59 ... 73	65 65 65	65 65 65	65 65 20	65 65 20	25 22 --	25 22 --
FLA ²⁾ max.	115/120	7.5	10							
73 A, 480 V	200/208	15	25							
52 A, 600 V	230/240	15	30							
	460/480	--	60							
	575/600	--	75							
Size S2, with increased switching capacity										
3RV2032 + 3RV2938-1K⁴⁾				14 ... 36 40 ... 52 59 ... 73	100 100 100	100 100 100	100 100 30	100 100 30	25 22 --	25 22 --
FLA ²⁾ max.	115/120	7.5	10							
73 A, 480 V	200/208	15	25							
52 A, 600 V	230/240	15	30							
	460/480	--	60							
	575/600	--	75							

Size S3 available on request

-- No approval

¹⁾ hp rating = Power rating in horse power (maximum motor rating).

²⁾ FLA = Full Load Amps/motor full load current.

³⁾ Corresponds to "short-circuit breaking capacity" according to UL/CSA.

⁴⁾ Not required for CSA.

⁵⁾ Alternatively phase barrier 3RV2928-1K can be used.

3RV27 and 3RV28 motor starter protectors as "circuit breakers"

These motor starter protectors are approved as circuit breakers according to UL 489 and CSA C22.2 No. 5. They can be used therefore as upstream short-circuit protective devices for "Manual Motor Controllers" and "Manual Motor Controllers Suitable for Tap Conductor Protection in Group Installations".

3RV27 and 3RV28 motor starter protectors are approved as "circuit breakers" under the following file numbers:

- UL File No. E235044, CCN: DIVQ
- CSA Master Contract 165071, Product Class: 1432 01

Motor starter protectors/ circuit breakers	Rated current I_n A	240 V AC		480 Y/277 V AC		480 V AC		600 Y/347 V AC	
		UL I_{bc1} kA	CSA I_{bc1} kA	UL I_{bc1} kA	CSA I_{bc1} kA	UL I_{bc1} kA	CSA I_{bc1} kA	UL I_{bc1} kA	CSA I_{bc1} kA
Type									
Size S00									
3RV2711	0.16 ... 12.5 15	65 65	65 65	65 65	65 65	-- --	-- --	10 --	10 --
3RV2811	0.16 ... 12.5 15	65 65	65 65	65 65	65 65	-- --	-- --	10 --	10 --
Size S0									
3RV2721	20; 22	50	50	50	50	--	--	--	--
3RV2821	20; 22	50	50	50	50	--	--	--	--
Size S3 available on request									

-- No approval

¹⁾ Corresponds to "short-circuit breaking capacity" according to UL.

Motor Starter Protectors/Circuit Breakers

SIRIUS 3RV2 Motor Starter Protectors/Circuit Breakers

General data

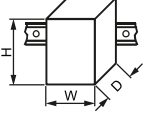
General data		3RV2.1.	3RV2.2.	3RV2.3.	3RV2.4.	3RV27, 3RV28
Type		S00	S0	S2	S3	S00, S0
Size						
Dimensions (W x H x D)		mm 45 x 97 x 91	45 x 97 x 91	55 x 140 x 149	70 x 165 x 169	45 x 144 x 92
• Screw terminals		mm 45 x 106 x 91	45 x 119 x 91	--	--	--
• Spring-type terminals						
Standards						
• IEC 60947-1, EN 60947-1 (VDE 0660 Part 100)		Yes				
• IEC 60947-2, EN 60947-2 (VDE 0660 Part 101)		Yes				
• IEC 60947-4-1, EN 60947-4-1 (VDE 0660 Part 102)		Yes	Yes	Yes	Yes	--
• UL 508/UL 60947-4-1, CSA C22.2 No. 14/CSA C22.2 No. 60947-4-1		Yes	Yes	Yes	Yes	--
• UL 489, CSA C22.2 No. 5		--	--	--	--	Yes
Number of poles		3				
Max. rated current I_n max (= max. rated operational current I_e)		A 16	40	80	100	22
Permissible ambient temperature						
• Storage/transport		°C -50 ... +80				
• Operation	I_n : 0.16 ... 32 A	°C -20 ... +70		--	--	--
	I_n : 36 ... 40 A	°C --	(current reduction above +60 °C) -20 ... +40 (The devices must not be mounted side-by-side and they must not be assembled with link modules with contactors. Lateral clearance = 9 mm)	--	--	--
	I_n : 14 ... 80 A	°C --		-20 ... +70 (current reduction above +60 °C)	--	--
	I_n : 40 ... 100 A	°C --		--	-20 ... +70 (current reduction above +60 °C)	--
Permissible rated current at inside temperature of control cabinet						
• +60 °C		% 100				
• +70 °C		% 87				
Permissible rated current at ambient temperature of enclosure (applies to motor starter protector/circuit breaker inside enclosure): S00/S0 ≤ 32 A, S2 ≤ 52 A)						
• +35 °C		% 100		100	100	
• +60 °C		% 87		--	87	
Rated operational voltage U_e						
• Acc. to IEC		V AC 690 (when a molded-plastic enclosure is used only 500 V)				
• Acc. to UL/CSA		V AC 600				
Rated frequency		Hz 50/60				
Rated insulation voltage U_i		V 690			1 000	690
Rated impulse withstand voltage U_{imp}		kV 6			8	6
Utilization category						
• IEC 60947-2 (motor starter protector/circuit breaker)		A				
• IEC 60947-4-1 (motor starter)		AC-3				
Trip class CLASS	Acc. to IEC 60947-4-1	10		10/20		--
DC short-circuit breaking capacity (time constant $t = 5$ ms)						
• 1 conducting path 150 V DC		kA 10		On request		10
• 2 conducting paths in series 300 V DC		kA 10				10
• 3 conducting paths in series 450 V DC		kA 10				10
Power loss P_p for each motor starter protector/circuit breaker	I_n : 0.16 ... 0.63 A	W 5				5
	I_n : 0.8 ... 6.3 A	W 6				6
	I_n : 8 ... 16 A	W 7				7
Dependent on rated current I_n (upper setting range)	I_n : 14 ... 16 A	W --		10	--	7
	I_n : 17 ... 25 A	W --	7		--	8
	I_n : 28 ... 32 A	W --	8	12	--	--
	I_n : 36 ... 40 A	W --	11	14	--	--
			14	15	--	--
	I_n : 45 ... 52 A	W --	--	17	--	--
	I_n : 59 ... 65 A	W --	--	19	--	--
	I_n : 73 ... 80 A	W --	--	21	--	--
	I_n : 40 ... 50 A	W --	--	--	21	--
	I_n : 63 ... 75 A	W --	--	--	21	--
	I_n : 84 ... 93 A	W --	--	--	32	--
	I_n : 100 A	W --	--	--	38	--
Shock resistance	Acc. to IEC 60068-2-27 g/ms	25/11 (square and sine pulse)				

Motor Starter Protectors/Circuit Breakers

SIRIUS 3RV2 Motor Starter Protectors/Circuit Breakers

General data

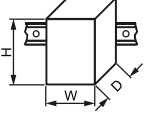
General data (continued)							
Type			3RV2.1.	3RV2.2.	3RV2.3.	3RV2.4.	3RV27, 3RV28
Size			S00	S0	S2	S3	S00, S0
Dimensions (W x H x D)		mm	45 x 97 x 91	45 x 97 x 91	55 x 140 x 149	70 x 165 x 169	45 x 144 x 92
• Screw terminals • Spring-type terminals		mm	45 x 106 x 91	45 x 119 x 91	--	--	--
Degree of protection	Acc. to IEC 60529		IP20			- IP20 (front side) - Terminal IP00 (use additional terminal covers for higher degree of protection)	
Touch protection	Acc. to IEC 60529		Finger-safe			Finger-safe, for vertical contact from the front	
Temperature compensation	Acc. to IEC 60947-4-1 °C		-20 ... +60				
Phase failure sensitivity	Acc. to IEC 60947-4-1		Yes (not for 3RV23 motor starter protectors)				No
Protection of motors in hazardous environments			Yes (only for 3RV20 motor starter protectors) DMT 02 ATEX F 001 ⚠ II (2) GD			On request	No
• EC type-examination certificate number according to European Directive 2014/34/EU (ATEX)						On request	No
• according to international standard IECEx			IECEx BVS1.0102 [Ex]			On request	No
Isolating function	Acc. to IEC 60947-2		Yes				
Main and EMERGENCY-STOP switch characteristics (with corresponding accessories)	Acc. to EN 60204-1 VDE 0113		Yes				
Protective separation between main and auxiliary circuits required for PELV-applications	Acc. to IEC 60947-1		Yes				
• Up to 400 V + 10 % • Up to 415 V + 5 % (higher voltages on request)			Yes				
Permissible mounting position			Any, acc. to IEC 60447 start command "I" right-hand side or top				
Mechanical endurance (operating cycles)			100 000		52 A: 50 000, 80 A: 20 000	On request	100 000
Electrical endurance (operating cycles)			100 000		52 A: 50 000, 80 A: 20 000	25 000	100 000
Max. switching frequency per hour (motor starts)	1/h		15				

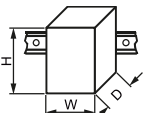
General data					
Type			3RV2742	3RV1611-0BD10¹⁾	
Size			S3	S00	
Dimensions (W x H x D)		mm	70 x 168 x 169	45 x 90 x 70	
Standards			Yes		
• IEC 60947-1, EN 60947-1 (VDE 0660 Part 100)			Yes		
• IEC 60947-2, EN 60947-2 (VDE 0660 Part 101)			No	Yes	
• UL 508/UL 60947-4-1, CSA C22.2 No.14/CSA 60947-4-1			Yes	No	
• UL 489, CSA C22.2 No.5					
Number of poles			3		
Max. rated current $I_{n \max}$ (= max. rated operational current I_e)	A		70	0.2	
Permissible ambient temperature			-50 ... +80		
• Storage/transport	°C		-20 ... +70 (current reduction above +60 °C)		
• Operation	°C				
Permissible rated current at inside temperature of control cabinet			100		
• +60 °C	%		87		
• +70 °C	%				
Permissible rated current at enclosure ambient temperature (applies for motor starter protector inside enclosure)			100		
• +35 °C	%		87		
• +60 °C	%				
Rated operational voltage U_e			690 (with molded-plastic enclosure 500 V)		
• Acc. to IEC	V AC		600		
• Acc. to UL/CSA	V AC				
Rated frequency	Hz		50/60		
Rated insulation voltage U_i	V		1 000	690	
Rated impulse withstand voltage U_{imp}	kV		8	6	
Utilization category			A		
• IEC 60947-2 (motor starter protector/circuit breaker)					
DC short-circuit breaking capacity (time constant $t = 5$ ms)			On request		
• 1 conducting path 150 V DC	kA				
• 2 conducting paths in series 300 V DC	kA				
• 3 conducting paths in series 450 V DC	kA				

¹⁾ "Technical Specifications" for 3RV1611 voltage transformer circuit breakers, see page 7/23.

Motor Starter Protectors/Circuit Breakers

SIRIUS 3RV2 Motor Starter Protectors/Circuit Breakers

General data

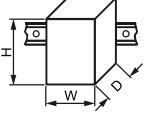
General data (continued)				
Type			3RV2742	3RV1611-0BD10¹⁾
Size			S3	S00
Dimensions (W x H x D)		mm	70 x 168 x 169	45 x 90 x 70
Power loss P_v for each motor starter protector/circuit breaker	I_n : 0.2 A	W	--	5
Dependent on rated current I_n (upper setting range)	I_n : 10 A	W	8	--
	I_n : 15 ... 35 A	W	12	--
	I_n : 40 ... 70 A	W	20	--
	$R_{\text{per conducting path}} = \frac{P}{I^2 \times 3}$			
Shock resistance	Acc. to IEC 60068-2-27	g/ms	25/11 (square and sine pulse)	
Degree of protection	Acc. to IEC 60529		- IP20 (front side) - Connecting terminal IP00	IP20
Touch protection	Acc. to IEC 60529		Finger-safe, for vertical contact from the front	Finger-safe
Temperature compensation	Acc. to IEC 60947-4-1	°C	-20 ... +60	
Phase failure sensitivity	Acc. to IEC 60947-4-1		No	Yes
Explosion protection – Safe operation of motors with "increased safety" type of protection			No	No
EC type-examination certificate number according to directive 2014/34/EU (ATEX)				
Isolating function	Acc. to IEC 60947-2		Yes	
Main and EMERGENCY-STOP switch characteristics (with corresponding accessories)	Acc. to EN 60204-1		Yes	
Protective separation between main and auxiliary circuits required for PELV applications	Acc. to IEC 60947-1		Yes	
• Up to 400 V + 10 %			Yes	
• Up to 415 V + 5 % (higher voltages on request)			Yes	
Permissible mounting position			Any, acc. to IEC 60447 start command "I" right-hand side or top	
Mechanical endurance	Operating cycles		On request	100 000
Electrical endurance	Operating cycles		25 000	100 000
Max. switching frequency per hour (motor starts)	1/h		15	

¹⁾ "Technical Specifications" for 3RV1611 voltage transformer circuit breakers, see page 7/23.

Rated data of the auxiliary switches and signaling switches			Lateral auxiliary switch with 1 NO + 1 NC, 2 NO, 2 NC, 2 NO + 2 NC	Signaling switch	Transverse auxiliary switch with 1 CO	1 NO + 1 NC, 2 NO
Max. rated voltage						
• Acc. to NEMA (UL)	V AC	600				250
• Acc. to NEMA (CSA)	V AC	600				250
Uninterrupted current	A	10			5	2.5
Switching capacity			1 NO + 1 NC, 2 NO, 2 NC; A600, Q300; 2 NO + 2 NC; A300, Q300	A600, Q300	B600, R300	C300, R300

Motor Starter Protectors/Circuit Breakers

SIRIUS 3RV2 Motor Starter Protectors/Circuit Breakers

General data

Front transverse auxiliary switches		Switching capacity for different voltages	
		1 CO	1 NO + 1 NC, 2 NO
Rated operational current I_e			
• At AC-15, alternating voltage			
- 24 V	A	4	2
- 230 V	A	3	0.5
• At AC-12 = I_{th} , alternating voltage			
- 24 V	A	10	2.5
- 230 V	A	10	2.5
• At DC-13, direct voltage L/R 200 ms			
- 24 V	A	1	1
- 48 V	A	--	0.3
- 60 V	A	--	0.15
- 110 V	A	0.22	--
- 220 V	A	0.1	--
Minimum load capacity	V	17	
	mA	1	

Front transverse solid-state compatible auxiliary switches		Switching capacity for different voltages	
		1 CO	
Rated operational voltage U_e	Alternating voltage	V	125
Rated operational current I_e /AC-14	At $U_e = 125$ V	A	0.1
Rated operational voltage U_e	Direct voltage L/R 200 ms	V	60
Rated operational current I_e /DC-13	At $U_e = 60$ V	A	0.3
Minimum load capacity	V	5	
	mA	1	

Lateral auxiliary switches with signaling switch		Switching capacity for different voltages: Lateral auxiliary switch with 1 NO + 1 NC, 2 NO, 2 NC, 2 NO + 2 NC; Signaling switch	
Rated operational current I_e			
• At AC-15, alternating voltage			
- 24 V	A	6	
- 230 V	A	4	
- 400 V	A	3	
- 690 V	A	1	
• At AC-12 = I_{th} , alternating voltage			
- 24 V	A	10	
- 230 V	A	10	
- 400 V	A	10	
- 690 V	A	10	
• At DC-13, direct voltage L/R 200 ms			
- 24 V	A	2	
- 110 V	A	0.5	
- 220 V	A	0.25	
- 440 V	A	0.1	
Minimum load capacity	V	17	
	mA	1	



Auxiliary releases		Undervoltage releases	Shunt releases
Power consumption			
• During pick-up			
- AC voltages	VA/W	20.2/13	20.2/13
- DC voltages	W	20	13 ... 80
• During uninterrupted duty			
- AC voltages	VA/W	7.2/2.4	--
- DC voltages	W	2.1	--
Response voltage			
• Tripping	V	0.35 ... 0.7 × U_s	0.7 ... 1.1 × U_s
• Pick-up	V	0.85 ... 1.1 × U_s	--
Opening time maximum	ms	20	

Short-circuit protection for auxiliary and control circuits		
Melting fuses operational class gG	A	10
Miniature circuit breakers C characteristic	A	6 (prospective short-circuit current < 0.4 kA)

Motor Starter Protectors/Circuit Breakers

SIRIUS 3RV2 Motor Starter Protectors/Circuit Breakers

General data



Conductor cross-sections of main circuit						
Type		3RV2.11	3RV2.21	3RV2.31-4B.1., 3RV2.31-4D.1., 3RV2.31-4E.1., 3RV2.31-4P.1., 3RV2.31-4S.1., 3RV2.31-4T.1., 3RV2.31-4U.1., 3RV2.31-4V.1.	3RV2.31-4J.1., 3RV2.31-4K.1., 3RV2.31-4R.1., 3RV2.31-4W.1., 3RV2.31-4X.1., 3RV2431-4VA1., 3RV2.32	3RV27, 3RV28
Size		S00	S0	S2		S00, S0
Connection type		 Screw terminals				
Terminal screw		M3, Pozidriv size 2	M4, Pozidriv size 2	M6, Pozidriv size 2		M4, Pozidriv size 2
Operating devices	mm	∅ 5 ... 6	∅ 5 ... 6	∅ 5 ... 6		∅ 5 ... 6
Prescribed tightening torque	Nm	0.8 ... 1.2	2 ... 2.5	3.0 ... 4.5		2.5 ... 3
Conductor cross-sections (min./max.), 1 or 2 conductors can be connected						
• Solid or stranded	mm ²	2 x (0.75 ... 2.5) ¹⁾ , 2 x 4	2 x (1 ... 2.5) ¹⁾ , 2 x (2.5 ... 10) ¹⁾	2 x (1 ... 25) ¹⁾ , 1 x (1 ... 35) ¹⁾	2 x (1 ... 35) ¹⁾ , 1 x (1 ... 50) ¹⁾	2 x (1 ... 10) ¹⁾ , max.. 1 x 25
• Finely stranded with end sleeve (DIN 46228-1)	mm ²	2 x (0.5 ... 1.5) ¹⁾ , 2 x (0.75 ... 2.5) ¹⁾	2 x (1 ... 2.5) ¹⁾ , 2 x (2.5 ... 6) ¹⁾ , 1 x 10	2 x (1 ... 16) ¹⁾ , 1 x (1 ... 25) ¹⁾	2 x (1 ... 25) ¹⁾ , 1 x (1 ... 35) ¹⁾	1 x (1 ... 16), max. 6 + 16
• AWG cables, solid or stranded	AWG	2 x (20 ... 16) ¹⁾ , 2 x (18 ... 12) ¹⁾	2 x (18 ... 12) ¹⁾ , 2 x (14 ... 8) ¹⁾	2 x (18 ... 3) ¹⁾ , 1 x (18 ... 2) ¹⁾	2 x (18 ... 2) ¹⁾ , 1 x (18 ... 1) ¹⁾	2 x (14 ... 10)
Connection type		 Spring-type terminals				
Operating devices	mm	3.0 x 0.5				
Conductor cross-sections (min./max.), 1 or 2 conductors can be connected						
• Solid or stranded	mm ²	2 x (0.5 ... 4)	2 x (1 ... 10)	--		
• Finely stranded without end sleeve	mm ²	2 x (0.5 ... 2.5)	2 x (1 ... 6)	--		
• Finely stranded with end sleeve (DIN 46228-1)	mm ²	2 x (0.5 ... 2.5)	2 x (1 ... 6)	--		
• AWG cables, solid or stranded	AWG	2 x (20 ... 12)	2 x (18 ... 8)	--		
Max. external diameter of the conductor insulation	mm	3.6	6.4	--		

¹⁾ If two different conductor cross-sections are connected to one clamping point, both cross-sections must be in the range specified.

Motor Starter Protectors/Circuit Breakers

SIRIUS 3RV2 Motor Starter Protectors/Circuit Breakers

General data

Conductor cross-sections of main circuit (continued)			
Type		3RV2.4/ 3RV2742	3RV1611-0BD10 ¹⁾
Size		S3	S00
Connection type		 Screw terminals with box terminal	 Screw terminals
Terminal screw		M6	Pozidriv size 2
Prescribed tightening torque	Nm	4.5 ... 6	
Conductor cross-sections (min./max.), 1 or 2 conductors can be connected			
• Solid or stranded	mm ²	2 x (2.5 ... 16) ²⁾ , 2 x (10 ... 50) ²⁾ , 1 x (10 ... 70) ²⁾	2 x (0.5 ... 1.5) ²⁾ , 2 x (0.75 ... 2.5) ²⁾
• Finely stranded with end sleeve (DIN 46228-1)	mm ²	2 x (2.5 ... 35) ²⁾ , 1 x (2.5 ... 50) ²⁾	2 x (0.5 ... 1.5) ²⁾ , 2 x (0.75 ... 2.5) ²⁾
• AWG cables, solid or stranded	AWG	2 x (10 ... 1/0) ²⁾ , 1 x (10 ... 2/0) ²⁾	2 x (18 ... 14)
Ribbon cable conductors (Number x Width x Thickness)	mm	2 x (6 x 9 x 0.8)	--
Removable box terminals³⁾			
• With copper bars ⁴⁾	mm	2 x 12 x 4	--
• With cable lugs ⁵⁾			
- Terminal screw		M6	
- Prescribed tightening torque	Nm	4.5 ... 6	
- Usable ring terminal lugs	mm	d ₂ = min. 6.3 d ₃ = max. 19	

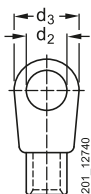



1) "Technical Specifications" for 3RV16 voltage transformer circuit breakers, see page 7/23.

2) If two different conductor cross-sections are connected to one clamping point, both cross-sections must be in the range specified.

3) Cable lug and busbar connection possible after removing the box terminals.

4) If bars larger than 12 mm x 10 mm are connected, a 3RT2946-4EA2 cover is needed to maintain the required phase clearance, see page 7/47.

5) When conductors larger than 25 mm² are connected, the 3RT2946-4EA2 cover is needed to maintain the required phase clearance, see page 7/47.

Conductor cross-sections for auxiliary and control circuits							
Type		3RV2.11	3RV1611- 0BD10 ¹⁾	3RV2.21	3RV2.3	3RV2.4	3RV27, 3RV28
Size		S00		S0	S2	S3	S00, S0, S3
Connection type		 Screw terminals					
Terminal screw		M3, Pozidriv size 2					
Operating devices	mm	∅ 5 ... 6					
Prescribed tightening torque	Nm	0.8 ... 1.2					
Conductor cross-sections (min./max.), 1 or 2 conductors can be connected							
• Solid or stranded	mm ²	2 x (0.5 ... 1.5) ²⁾ , 2 x (0.75 ... 2.5) ²⁾					
• Finely stranded with end sleeve (DIN 46228-1)	mm ²	2 x (0.5 ... 1.5) ²⁾ , 2 x (0.75 ... 2.5) ²⁾					
• AWG cables, solid or stranded	AWG	2 x (18 ... 14) ²⁾ , 2 x (20 ... 16) ²⁾					
Connection type		 Spring-type terminals					
Operating devices	mm	3.0 x 0.5					
Conductor cross-sections (min./max.), 1 or 2 conductors can be connected							
• Solid or stranded	mm ²	2 x (0.5 ... 2.5)					
• Finely stranded without end sleeve	mm ²	2 x (0.5 ... 2.5)					
• Finely stranded with end sleeve (DIN 46228-1)	mm ²	2 x (0.5 ... 1.5)					
• AWG cables, solid or stranded	AWG	2 x (20 ... 14)					
Max. external diameter of the conductor insulation	mm	3.6					

1) "Technical Specifications" for 3RV16 voltage transformer circuit breakers, see page 7/23.

2) If two different conductor cross-sections are connected to one clamping point, both cross-sections must be in the range specified.

Motor Starter Protectors/Circuit Breakers

SIRIUS 3RV2 Motor Starter Protectors/Circuit Breakers

General data

Voltage transformer circuit breakers

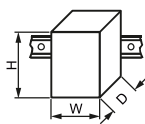
General data					
Type			3RV1611-1AG14	3RV1611-1CG14	3RV1611-1DG14
Size			S00	S00	S00
Dimensions (W x H x D)		mm	45 x 90 x 70	45 x 90 x 70	45 x 90 x 70
Rated current I_n	A		1.4	2.5	3
Ambient temperature					
• During storage/transport	°C		-50 ... +80		
• During operation	°C		-20 ... +60 (up to +70 °C possible with current reduction)		
Rated operational voltage U_e	V		400		
Rated frequency	Hz		16.66 ... 60		
Rated insulation voltage U_i	V		690		
Short-circuit breaking capacity I_{cu} at 400 V AC	kA		50		
Set value of the thermal overload release	A		1.4	2.5	3
Response value of the instantaneous overcurrent release	A		6 ± 20 %	10.5 ± 20 %	20 ± 20 %
Tripping time of the instantaneous overcurrent release	ms		Approx. 6 at 12 A	Approx. 6 at 20 A	Approx. 6 at 40 A
Internal resistance					
• In cold state	Ω		> 0.25 ± 6.5 %		
• In heated state	Ω		> 0.30 ± 6.5 %		
Shock resistance acc. to IEC 60068-2-27	g/ms		15		
Degree of protection acc. to IEC 60529			IP20		
Touch protection acc. to EN 50274			Finger-safe for vertical contact from the front		
Endurance					
• Mechanical	Operating cycles		10 000		
• Electrical	Operating cycles		10 000		
Permissible mounting position			Any		

Type		3RV1611-1AG14	3RV1611-1CG14	3RV1611-1DG14
Conductor cross-sections, main circuit, 1 or 2 conductors				
Connection type		 Screw terminals		
Terminal screw		Pozidriv size 2		
Conductor cross-sections (min./max.), 1 or 2 conductors can be connected				
• Solid or stranded	mm ²	2 x (0.5 ... 1.5) ¹⁾ , 2 x (0.75 ... 2.5) ¹⁾ , 2 x (1 ... 4)		
• Finely stranded with end sleeve (DIN 46228-1)	mm ²	2 x (0.5 ... 1.5) ¹⁾ , 2 x (0.75 ... 2.5) ¹⁾		
Auxiliary switches for blocking the distance protection				
With defined lateral assignment for blocking distance protection		1 CO (for use as 1 NO or 1 NC)		
Rated operational voltage U_e	Alternating voltage	V	125	
Rated operational current I_e /AC-14	At $U_e = 125$ V	A	0.1	
Rated operational voltage U_e	Direct voltage L/R 200 ms	V	60	
Rated operational current I_e /DC-13	At $U_e = 60$ V	A	0.3	
Minimum load capacity		V	5	
		mA	1	
Short-circuit protection for auxiliary circuit				
Melting fuse	A	250 V type FF 2A (prospective short-circuit current < 1.1 kA)		



¹⁾ If two different conductor cross-sections are connected to one clamping point, both cross-sections must be in the range specified.

Motor Starter Protectors/Circuit Breakers

SIRIUS 3RV2 Motor Starter Protectors/Circuit Breakers

General data

Terminals for "Self-Protected Combination Motor Controllers (Type E) according to UL 508/UL 60947-4-1"

Type	3RV2928-1H	
Prescribed tightening torque	Nm	2.5 ... 3
Conductor cross-sections		
<ul style="list-style-type: none"> • Front clamping point connected 		
<ul style="list-style-type: none"> - Solid 	mm ²	1 ... 10
<ul style="list-style-type: none"> - Finely stranded with end sleeve 	mm ²	1 ... 16
<ul style="list-style-type: none"> - Stranded 	mm ²	2.5 ... 25
<ul style="list-style-type: none"> - AWG cables, solid or stranded 	AWG	14 ... 3
<ul style="list-style-type: none"> - Terminal screw 		M4
<ul style="list-style-type: none"> • Rear clamping point connected 		
<ul style="list-style-type: none"> - Solid 	mm ²	1 ... 10
<ul style="list-style-type: none"> - Finely stranded with end sleeve 	mm ²	1 ... 16
<ul style="list-style-type: none"> - Stranded 	mm ²	1.5 ... 25
<ul style="list-style-type: none"> - AWG cables, solid or stranded 	AWG	14 ... 6
<ul style="list-style-type: none"> - Terminal screw 		M4
<ul style="list-style-type: none"> • Both clamping points connected 		
<ul style="list-style-type: none"> - Front clamping point: 		
<ul style="list-style-type: none"> - Solid 	mm ²	1 ... 10
<ul style="list-style-type: none"> - Finely stranded with end sleeve 	mm ²	1 ... 10 ¹⁾ , 1 ... 6 ¹⁾
<ul style="list-style-type: none"> - Stranded 	mm ²	2.5 ... 10
<ul style="list-style-type: none"> - AWG cables, solid or stranded 	AWG	14 ... 6
<ul style="list-style-type: none"> - Terminal screw 		M4
<ul style="list-style-type: none"> - Rear clamping point: 		
<ul style="list-style-type: none"> - Solid 	mm ²	1 ... 10
<ul style="list-style-type: none"> - Finely stranded with end sleeve 	mm ²	1 ... 10 ¹⁾ , 1 ... 16 ¹⁾
<ul style="list-style-type: none"> - Stranded 	mm ²	2.5 ... 10
<ul style="list-style-type: none"> - AWG cables, solid or stranded 	AWG	16 ... 3
<ul style="list-style-type: none"> - Terminal screw 		M4

¹⁾ The following connections are possible when both clamping points are connected:

- front 1 ... 10 mm² and rear 1 ... 10 mm²,
- front 1 ... 6 mm² and rear 1 ... 16 mm².

Motor Starter Protectors/Circuit Breakers

SIRIUS 3RV2 Motor Starter Protectors/Circuit Breakers

General data

Motor feeder connectors for motor starter protectors/ circuit breakers with screw terminals			
Version	Type	3RT1900-4RE01 Motor feeder connector S0	3RT1926-4RD01 Adapter S0
General data			
Rated insulation voltage U_i (pollution degree 3)	V	690	
Rated impulse withstand voltage U_{imp} (pollution degree 3)	kV	6	
Rated operational voltage U_e	V	440	
Rated frequency f For AC operation	Hz	50/60	
Rated operational current I_e AC-3 at 400 V	A	25	
Mechanical endurance	Operating cycles	10 million	
Electrical endurance at I_e	Operating cycles	1 million	
Protective separation according to IEC 60947-1 (pollution degree 3)	V	400	
Permissible ambient temperature			
• During operation	°C	-25 ... +60	
• During storage	°C	-50 ... +80	
Degree of protection acc. to IEC 60529		IP20 (front side)	
Conductor cross-sections			
Connection type		⊕ Screw terminals	
• Solid	mm ²	1 x (0.5 ... 6)	
• Finely stranded without/with end sleeve	mm ²	1 x (0.5 ... 6)	
• Stranded	mm ²	1 x (0.5 ... 6)	
• AWG cables, solid or stranded	AWG	1 x (20 ... 10)	
• Tightening torque	Nm	0.6 ... 0.8	
• Corresponding opening tool		Cross-tip screwdriver PZ2	
Ⓢ and Ⓜ rated data			
Rated operational voltage U_e	V	480	
Rated insulation voltage U_i	V	600	
Uninterrupted current, at 40 °C	A	25	
Short-circuit protection ¹⁾			
• At 600 V	kA	5	
• CLASS RK5 fuse	A	100	
• Circuit breaker with overload protection acc. to UL 489	A	100	
Combination motor controllers type E according to UL 508			
At 480 V	Type	3RV202	
	A	22	
	kA	65	
At 600 V	Type	3RV202	
	A	22	
	kA	10	

¹⁾ For more information about short-circuit values, e.g. for protection against high short-circuit currents, see the UL reports of the individual devices, www.siemens.com/sirius/manuals.

Motor Starter Protectors/Circuit Breakers

SIRIUS 3RV2 Motor Starter Protectors/Circuit Breakers

For motor protection **IE3/IE4 ready**

Selection and ordering data

CLASS 10, without auxiliary switches

PU (UNIT, SET, M) = 1
 PS* = 1 unit
 PG = 41E

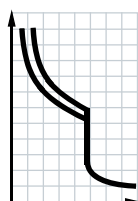

Rated current	Suitable for three-phase motors ¹⁾ with P	Setting range for thermal overload release	Instantaneous overcurrent release	Short-circuit breaking capacity at 400 V AC	SD	Screw terminals	SD	Spring-type terminals	
I_n			$I >$	I_{cu}	d	Article No.	Price per PU	Article No.	Price per PU
A	kW	A	A	kA			d		
Size S00									
0.16	0.04	0.11 ... 0.16	2.1	100		3RV2011-0AA10		3RV2011-0AA20	
0.2	0.06	0.14 ... 0.2	2.6	100		3RV2011-0BA10		3RV2011-0BA20	
0.25	0.06	0.18 ... 0.25	3.3	100		3RV2011-0CA10		3RV2011-0CA20	
0.32	0.09	0.22 ... 0.32	4.2	100		3RV2011-0DA10		3RV2011-0DA20	
0.4	0.09	0.28 ... 0.4	5.2	100		3RV2011-0EA10		3RV2011-0EA20	
0.5	0.12	0.35 ... 0.5	6.5	100		3RV2011-0FA10		3RV2011-0FA20	
0.63	0.18	0.45 ... 0.63	8.2	100		3RV2011-0GA10		3RV2011-0GA20	
0.8	0.18	0.55 ... 0.8	10	100		3RV2011-0HA10		3RV2011-0HA20	
1	0.25	0.7 ... 1	13	100		3RV2011-0JA10		3RV2011-0JA20	
1.25	0.37	0.9 ... 1.25	16	100		3RV2011-0KA10		3RV2011-0KA20	
1.6	0.55	1.1 ... 1.6	21	100		3RV2011-1AA10		3RV2011-1AA20	
2	0.75	1.4 ... 2	26	100		3RV2011-1BA10		3RV2011-1BA20	
2.5	0.75	1.8 ... 2.5	33	100		3RV2011-1CA10		3RV2011-1CA20	
3.2	1.1	2.2 ... 3.2	42	100		3RV2011-1DA10		3RV2011-1DA20	
4	1.5	2.8 ... 4	52	100		3RV2011-1EA10		3RV2011-1EA20	
5	1.5	3.5 ... 5	65	100		3RV2011-1FA10		3RV2011-1FA20	
6.3	2.2	4.5 ... 6.3	82	100		3RV2011-1GA10		3RV2011-1GA20	
8	3	5.5 ... 8	104	100		3RV2011-1HA10		3RV2011-1HA20	
10	4	7 ... 10	130	100		3RV2011-1JA10		3RV2011-1JA20	
12.5	5.5	9 ... 12.5	163	100		3RV2011-1KA10		3RV2011-1KA20	
16	7.5	10 ²⁾ ... 16	208	55		3RV2011-4AA10		3RV2011-4AA20	
Size S0									
0.63	0.18	0.45 ... 0.63	8.2	100	5	3RV2021-0GA10	5	3RV2021-0GA20	
0.8	0.18	0.55 ... 0.8	10	100	5	3RV2021-0HA10	5	3RV2021-0HA20	
1	0.25	0.7 ... 1	13	100	5	3RV2021-0JA10	5	3RV2021-0JA20	
1.25	0.37	0.9 ... 1.25	16	100	5	3RV2021-0KA10	5	3RV2021-0KA20	
1.6	0.55	1.1 ... 1.6	21	100	5	3RV2021-1AA10	5	3RV2021-1AA20	
2	0.75	1.4 ... 2	26	100	5	3RV2021-1BA10	5	3RV2021-1BA20	
2.5	0.75	1.8 ... 2.5	33	100	5	3RV2021-1CA10	5	3RV2021-1CA20	
3.2	1.1	2.2 ... 3.2	42	100	5	3RV2021-1DA10	5	3RV2021-1DA20	
4	1.5	2.8 ... 4	52	100	5	3RV2021-1EA10	5	3RV2021-1EA20	
5	1.5	3.5 ... 5	65	100	5	3RV2021-1FA10	5	3RV2021-1FA20	
6.3	2.2	4.5 ... 6.3	82	100	5	3RV2021-1GA10	5	3RV2021-1GA20	
8	3	5.5 ... 8	104	100	5	3RV2021-1HA10	5	3RV2021-1HA20	
10	4	7 ... 10	130	100	5	3RV2021-1JA10	5	3RV2021-1JA20	
12.5	5.5	9 ... 12.5	163	100	5	3RV2021-1KA10	5	3RV2021-1KA20	
16	7.5	10 ²⁾ ... 16	208	55		3RV2021-4AA10		3RV2021-4AA20	
20	7.5	13 ²⁾ ... 20	260	55		3RV2021-4BA10		3RV2021-4BA20	
22	11	16 ²⁾ ... 22	286	55		3RV2021-4CA10		3RV2021-4CA20	
25	11	18 ²⁾ ... 25	325	55		3RV2021-4DA10		3RV2021-4DA20	
28	15	23 ... 28	364	55		3RV2021-4NA10		3RV2021-4NA20	
32 ³⁾	15	27 ... 32	400	55		3RV2021-4EA10		3RV2021-4EA20	
36 ⁴⁾	18.5	30 ... 36	432	20		3RV2021-4PA10		--	
40 ⁴⁾	18.5	34 ... 40	480	20		3RV2021-4FA10		--	

¹⁾ Guide value for 4-pole standard motors at 50 Hz 400 V AC. The actual starting and rated data of the motor to be protected must be considered when selecting the units.
²⁾ The setting range of the thermal overload releases has been extended.
³⁾ Suitable for use with IE3/IE4 motors up to a starting current of 256 A. For higher starting currents we recommend using 3RV2 motor starter protectors size S2.

⁴⁾ The devices must not be mounted side-by-side and they must not be assembled with link modules with contactors. A lateral clearance of 9 mm is required. For use with IE3/IE4 motors we recommend using 3RV2 motor starter protectors size S2.

Auxiliary switches and other accessories can be ordered separately (see "Accessories" page 7/38 onwards).

Motor Starter Protectors/Circuit Breakers SIRIUS 3RV2 Motor Starter Protectors/Circuit Breakers

IE3/IE4 ready For motor protection

CLASS 10, without auxiliary switches

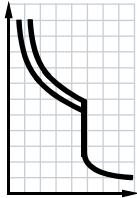

3RV2031-4SA10



3RV2032-4RA10



3RV2042-4MA10

Rated current	Suitable for three-phase motors ¹⁾ with P	Setting range for thermal overload release	Instantaneous overcurrent release	Short-circuit breaking capacity at 400 V AC	SD	Screw terminals	PU (UNIT, SET, M)	PS*	PG
I_n	kW			I_{cu}	d	Article No.	Price per PU		
Size S2									
14	5.5	9.5 ... 14	208	65	▶	3RV2031-4SA10	1	1 unit	41E
17	7.5	12 ... 17	260	65	▶▶	3RV2031-4TA10	1	1 unit	41E
20	7.5	14 ... 20	260	65	▶▶▶	3RV2031-4BA10	1	1 unit	41E
25	11	18 ... 25	325	65	▶▶▶▶	3RV2031-4DA10	1	1 unit	41E
32	15	22 ... 32	416	65	▶▶▶▶▶	3RV2031-4EA10	1	1 unit	41E
36	18.5	28 ... 36	520	65	▶▶▶▶▶▶	3RV2031-4PA10	1	1 unit	41E
40	18.5	32 ... 40	585	65	▶▶▶▶▶▶▶	3RV2031-4UA10	1	1 unit	41E
45	22	35 ... 45	650	65	▶▶▶▶▶▶▶▶	3RV2031-4VA10	1	1 unit	41E
52	22	42 ... 52	741	65	▶▶▶▶▶▶▶▶▶	3RV2031-4WA10	1	1 unit	41E
59	30	49 ... 59	845	65	▶▶▶▶▶▶▶▶▶▶	3RV2031-4XA10	1	1 unit	41E
65	30	54 ... 65	845	65	▶▶▶▶▶▶▶▶▶▶▶	3RV2031-4JA10	1	1 unit	41E
73	37	62 ... 73	949	65	▶▶▶▶▶▶▶▶▶▶▶▶	3RV2031-4KA10	1	1 unit	41E
80 ²⁾	37	70 ... 80	1 040	65	▶▶▶▶▶▶▶▶▶▶▶▶▶	3RV2031-4RA10	1	1 unit	41E
Size S2, with increased switching capacity									
14	5.5	9.5 ... 14	208	100	▶	3RV2032-4SA10	1	1 unit	41E
17	7.5	12 ... 17	260	100	▶▶	3RV2032-4TA10	1	1 unit	41E
20	7.5	14 ... 20	260	100	▶▶▶	3RV2032-4BA10	1	1 unit	41E
25	11	18 ... 25	325	100	▶▶▶▶	3RV2032-4DA10	1	1 unit	41E
32	15	22 ... 32	416	100	▶▶▶▶▶	3RV2032-4EA10	1	1 unit	41E
36	18.5	28 ... 36	520	100	▶▶▶▶▶▶	3RV2032-4PA10	1	1 unit	41E
40	18.5	32 ... 40	585	100	▶▶▶▶▶▶▶	3RV2032-4UA10	1	1 unit	41E
45	22	35 ... 45	650	100	▶▶▶▶▶▶▶▶	3RV2032-4VA10	1	1 unit	41E
52	22	42 ... 52	741	100	▶▶▶▶▶▶▶▶▶	3RV2032-4WA10	1	1 unit	41E
59	30	49 ... 59	845	100	▶▶▶▶▶▶▶▶▶▶	3RV2032-4XA10	1	1 unit	41E
65	30	54 ... 65	845	100	▶▶▶▶▶▶▶▶▶▶▶	3RV2032-4JA10	1	1 unit	41E
73	37	62 ... 73	949	100	▶▶▶▶▶▶▶▶▶▶▶▶	3RV2032-4KA10	1	1 unit	41E
80 ²⁾	37	70 ... 80	1 040	100	▶▶▶▶▶▶▶▶▶▶▶▶▶	3RV2032-4RA10	1	1 unit	41E
Size S3 NEW									
40	18.5	28 ... 40	520	65	1	3RV2041-4FA10	1	1 unit	41E
50	22	36 ... 50	650	65	1	3RV2041-4HA10	1	1 unit	41E
63	30	45 ... 63	819	65	1	3RV2041-4JA10	1	1 unit	41E
75	37	57 ... 75	975	65	1	3RV2041-4KA10	1	1 unit	41E
84	45	65 ... 84	1 170	65	1	3RV2041-4RA10	1	1 unit	41E
93	45	75 ... 93	1 300	65	1	3RV2041-4YA10	1	1 unit	41E
100	45, 55	80 ... 100	1 300	65	1	3RV2041-4MA10	1	1 unit	41E
Size S3, with increased switching capacity NEW									
40	18.5	28 ... 40	520	100	1	3RV2042-4FA10	1	1 unit	41E
50	22	36 ... 50	650	100	1	3RV2042-4HA10	1	1 unit	41E
63	30	45 ... 63	819	100	1	3RV2042-4JA10	1	1 unit	41E
75	37	57 ... 75	975	100	1	3RV2042-4KA10	1	1 unit	41E
84	45	65 ... 84	1 170	100	1	3RV2042-4RA10	1	1 unit	41E
93	45	75 ... 93	1 300	100	1	3RV2042-4YA10	1	1 unit	41E
100	45, 55	80 ... 100	1 300	100	1	3RV2042-4MA10	1	1 unit	41E

¹⁾ Guide value for 4-pole standard motors at 50 Hz 400 V AC. The actual starting and rated data of the motor to be protected must be considered when selecting the units.
²⁾ Suitable for use with IE3/IE4 motors up to a starting current of 720 A. For higher starting currents we recommend using motor starter protectors size S3.

Auxiliary switches and other accessories can be ordered separately (see "Accessories" page 7/38 onwards).

Motor Starter Protectors/Circuit Breakers

SIRIUS 3RV2 Motor Starter Protectors/Circuit Breakers

For motor protection **IE3/IE4 ready**

CLASS 10, with transverse auxiliary switch (1 NO + 1 NC)

PU (UNIT, SET, M) = 1
 PS* = 1 unit
 PG = 41E

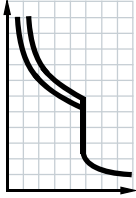

3RV2011-4AA15 with integrated transverse auxiliary switch



3RV2011-0EA25 with integrated transverse auxiliary switch



3RV2021-4AA15 with integrated transverse auxiliary switch



3RV2021-4AA25 with integrated transverse auxiliary switch

Rated current	Suitable for three-phase motors ¹⁾ with P	Setting range for thermal overload release	Instantaneous overcurrent release	Short-circuit breaking capacity at 400 V AC	SD	Screw terminals	SD	Spring-type terminals	
I_n			$I >$	I_{cu}	d	Article No.	Price per PU	Article No.	Price per PU
A	kW	A	A	kA			d		
Size S00									
0.16	0.04	0.11 ... 0.16	2.1	100	▶	3RV2011-0AA15	▶	3RV2011-0AA25	
0.2	0.06	0.14 ... 0.2	2.6	100	▶▶	3RV2011-0BA15	▶▶	3RV2011-0BA25	
0.25	0.06	0.18 ... 0.25	3.3	100	▶▶▶	3RV2011-0CA15	▶▶▶	3RV2011-0CA25	
0.32	0.09	0.22 ... 0.32	4.2	100	▶▶▶▶	3RV2011-0DA15	▶▶▶▶	3RV2011-0DA25	
0.4	0.09	0.28 ... 0.4	5.2	100	▶▶▶▶▶	3RV2011-0EA15	▶▶▶▶▶	3RV2011-0EA25	
0.5	0.12	0.35 ... 0.5	6.5	100	▶▶▶▶▶▶	3RV2011-0FA15	▶▶▶▶▶▶	3RV2011-0FA25	
0.63	0.18	0.45 ... 0.63	8.2	100	▶▶▶▶▶▶▶	3RV2011-0GA15	▶▶▶▶▶▶▶	3RV2011-0GA25	
0.8	0.18	0.55 ... 0.8	10	100	▶▶▶▶▶▶▶▶	3RV2011-0HA15	▶▶▶▶▶▶▶▶	3RV2011-0HA25	
1	0.25	0.7 ... 1	13	100	▶▶▶▶▶▶▶▶▶	3RV2011-0JA15	▶▶▶▶▶▶▶▶▶	3RV2011-0JA25	
1.25	0.37	0.9 ... 1.25	16	100	▶▶▶▶▶▶▶▶▶▶	3RV2011-0KA15	▶▶▶▶▶▶▶▶▶▶	3RV2011-0KA25	
1.6	0.55	1.1 ... 1.6	21	100	▶▶▶▶▶▶▶▶▶▶▶	3RV2011-1AA15	▶▶▶▶▶▶▶▶▶▶▶	3RV2011-1AA25	
2	0.75	1.4 ... 2	26	100	▶▶▶▶▶▶▶▶▶▶▶▶	3RV2011-1BA15	▶▶▶▶▶▶▶▶▶▶▶▶	3RV2011-1BA25	
2.5	0.75	1.8 ... 2.5	33	100	▶▶▶▶▶▶▶▶▶▶▶▶▶	3RV2011-1CA15	▶▶▶▶▶▶▶▶▶▶▶▶▶	3RV2011-1CA25	
3.2	1.1	2.2 ... 3.2	42	100	▶▶▶▶▶▶▶▶▶▶▶▶▶▶	3RV2011-1DA15	▶▶▶▶▶▶▶▶▶▶▶▶▶▶	3RV2011-1DA25	
4	1.5	2.8 ... 4	52	100	▶▶▶▶▶▶▶▶▶▶▶▶▶▶▶	3RV2011-1EA15	▶▶▶▶▶▶▶▶▶▶▶▶▶▶▶	3RV2011-1EA25	
5	1.5	3.5 ... 5	65	100	▶▶▶▶▶▶▶▶▶▶▶▶▶▶▶▶	3RV2011-1FA15	▶▶▶▶▶▶▶▶▶▶▶▶▶▶▶▶	3RV2011-1FA25	
6.3	2.2	4.5 ... 6.3	82	100	▶▶▶▶▶▶▶▶▶▶▶▶▶▶▶▶▶	3RV2011-1GA15	▶▶▶▶▶▶▶▶▶▶▶▶▶▶▶▶▶	3RV2011-1GA25	
8	3	5.5 ... 8	104	100	▶▶▶▶▶▶▶▶▶▶▶▶▶▶▶▶▶▶	3RV2011-1HA15	▶▶▶▶▶▶▶▶▶▶▶▶▶▶▶▶▶▶	3RV2011-1HA25	
10	4	7 ... 10	130	100	▶▶▶▶▶▶▶▶▶▶▶▶▶▶▶▶▶▶▶	3RV2011-1JA15	▶▶▶▶▶▶▶▶▶▶▶▶▶▶▶▶▶▶▶	3RV2011-1JA25	
12.5	5.5	9 ... 12.5	163	100	▶▶▶▶▶▶▶▶▶▶▶▶▶▶▶▶▶▶▶▶	3RV2011-1KA15	▶▶▶▶▶▶▶▶▶▶▶▶▶▶▶▶▶▶▶▶	3RV2011-1KA25	
16	7.5	10 ²⁾ ... 16	208	55	▶▶▶▶▶▶▶▶▶▶▶▶▶▶▶▶▶▶▶▶▶	3RV2011-4AA15	▶▶▶▶▶▶▶▶▶▶▶▶▶▶▶▶▶▶▶▶▶	3RV2011-4AA25	
Size S0									
16	7.5	10 ²⁾ ... 16	208	55	▶▶▶▶▶▶▶▶▶▶▶▶▶▶▶▶▶▶▶▶▶	3RV2021-4AA15	▶▶▶▶▶▶▶▶▶▶▶▶▶▶▶▶▶▶▶▶▶	3RV2021-4AA25	
20	7.5	13 ²⁾ ... 20	260	55	▶▶▶▶▶▶▶▶▶▶▶▶▶▶▶▶▶▶▶▶▶▶	3RV2021-4BA15	▶▶▶▶▶▶▶▶▶▶▶▶▶▶▶▶▶▶▶▶▶▶	3RV2021-4BA25	
22	11	16 ²⁾ ... 22	286	55	▶▶▶▶▶▶▶▶▶▶▶▶▶▶▶▶▶▶▶▶▶▶▶	3RV2021-4CA15	▶▶▶▶▶▶▶▶▶▶▶▶▶▶▶▶▶▶▶▶▶▶▶	3RV2021-4CA25	
25	11	18 ²⁾ ... 25	325	55	▶▶▶▶▶▶▶▶▶▶▶▶▶▶▶▶▶▶▶▶▶▶▶▶	3RV2021-4DA15	▶▶▶▶▶▶▶▶▶▶▶▶▶▶▶▶▶▶▶▶▶▶▶▶	3RV2021-4DA25	
28	15	23 ... 28	364	55	▶▶▶▶▶▶▶▶▶▶▶▶▶▶▶▶▶▶▶▶▶▶▶▶▶	3RV2021-4NA15	▶▶▶▶▶▶▶▶▶▶▶▶▶▶▶▶▶▶▶▶▶▶▶▶▶	3RV2021-4NA25	
32 ³⁾	15	27 ... 32	400	55	▶▶▶▶▶▶▶▶▶▶▶▶▶▶▶▶▶▶▶▶▶▶▶▶▶▶	3RV2021-4EA15	▶▶▶▶▶▶▶▶▶▶▶▶▶▶▶▶▶▶▶▶▶▶▶▶▶▶	3RV2021-4EA25	
36 ⁴⁾	18.5	30 ... 36	432	20	▶▶▶▶▶▶▶▶▶▶▶▶▶▶▶▶▶▶▶▶▶▶▶▶▶▶▶	3RV2021-4PA15	▶▶▶▶▶▶▶▶▶▶▶▶▶▶▶▶▶▶▶▶▶▶▶▶▶▶▶	--	
40 ⁴⁾	18.5	34 ... 40	480	20	▶▶▶▶▶▶▶▶▶▶▶▶▶▶▶▶▶▶▶▶▶▶▶▶▶▶▶▶	3RV2021-4FA15	▶▶▶▶▶▶▶▶▶▶▶▶▶▶▶▶▶▶▶▶▶▶▶▶▶▶▶▶	--	

1) Guide value for 4-pole standard motors at 50 Hz 400 V AC. The actual starting and rated data of the motor to be protected must be considered when selecting the units.
 2) The setting range of the thermal overload releases has been extended.
 3) Suitable for use with IE3/IE4 motors up to a starting current of 256 A. For higher starting currents we recommend using 3RV2 motor starter protectors size S2.
 4) The devices must not be mounted side-by-side and they must not be assembled with link modules with contactors. A lateral clearance of 9 mm is required. For use with IE3/IE4 motors we recommend using 3RV2 motor starter protectors size S2.

Auxiliary switches and other accessories can be ordered separately (see "Accessories" page 7/38 onwards).

Motor Starter Protectors/Circuit Breakers SIRIUS 3RV2 Motor Starter Protectors/Circuit Breakers

IE3/IE4 ready For motor protection

CLASS 20, without auxiliary switches



Rated current	Suitable for three-phase motors ¹⁾ with P	Setting range for thermal overload release	Instantaneous overcurrent release	Short-circuit breaking capacity at 400 V AC	SD	Screw terminals	PU (UNIT, SET, M)	PS*	PG
I_n				I_{cu}	d	Article No.	Price per PU		
A	kW	A	A	kA					
Size S2									
14	5.5	9.5 ... 14	208	65	2	3RV2031-4SB10	1	1 unit	41E
17	7.5	12 ... 17	260	65	2	3RV2031-4TB10	1	1 unit	41E
20	7.5	14 ... 20	260	65	2	3RV2031-4BB10	1	1 unit	41E
25	11	18 ... 25	325	65	2	3RV2031-4DB10	1	1 unit	41E
32	15	22 ... 32	416	65	2	3RV2031-4EB10	1	1 unit	41E
36	18.5	28 ... 36	520	65	2	3RV2031-4PB10	1	1 unit	41E
40	18.5	32 ... 40	585	65	2	3RV2031-4UB10	1	1 unit	41E
45	22	35 ... 45	650	65	2	3RV2031-4VB10	1	1 unit	41E
52	22	42 ... 52	741	65	2	3RV2031-4WB10	1	1 unit	41E
59	30	49 ... 59	845	65	▶	3RV2031-4XB10	1	1 unit	41E
65	30	54 ... 65	845	65	▶	3RV2031-4JB10	1	1 unit	41E
Size S3, with increased switching capacity NEW									
40	18.5	28 ... 40	520	100	2	3RV2042-4FB10	1	1 unit	41E
50	22	36 ... 50	650	100	2	3RV2042-4HB10	1	1 unit	41E
63	30	45 ... 63	819	100	2	3RV2042-4JB10	1	1 unit	41E
75	37	57 ... 75	975	100	2	3RV2042-4KB10	1	1 unit	41E
84	45	65 ... 84	1 170	100	2	3RV2042-4RB10	1	1 unit	41E
93	45	75 ... 93	1 300	100	2	3RV2042-4YB10	1	1 unit	41E
100	45, 55	80 ... 100	1 300	100	2	3RV2042-4MB10	1	1 unit	41E

¹⁾ Guide value for 4-pole standard motors at 50 Hz 400 V AC. The actual starting and rated data of the motor to be protected must be considered when selecting the units.

Auxiliary switches and other accessories can be ordered separately (see "Accessories" page 7/38 onwards).



Motor Starter Protectors/Circuit Breakers

SIRIUS 3RV2 Motor Starter Protectors/Circuit Breakers

For motor protection with overload relay function **IE3/IE4 ready**

Selection and ordering data

CLASS 10, with overload relay function (automatic RESET), without auxiliary switches

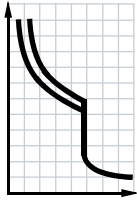

3RV2111-4FA10



3RV2111-0BA10



3RV2131-4WB10



3RV2142-4FA10

Rated current	Suitable for three-phase motors ¹⁾ with P	Setting range for thermal overload release	Instantaneous overcurrent release	Short-circuit breaking capacity at 400 V AC	SD	Screw terminals	⊕	PU (UNIT, SET, M)	PS*	PG
I_n				I_{cu}	d	Article No.	Price per PU			
A	kW	A	A	kA						
Size S00²⁾										
0.16	0.04	0.11 ... 0.16	2.1	100	2	3RV2111-0AA10		1	1 unit	41E
0.2	0.06	0.14 ... 0.2	2.6	100	2	3RV2111-0BA10		1	1 unit	41E
0.25	0.06	0.18 ... 0.25	3.3	100	2	3RV2111-0CA10		1	1 unit	41E
0.32	0.09	0.22 ... 0.32	4.2	100	2	3RV2111-0DA10		1	1 unit	41E
0.4	0.09	0.28 ... 0.4	5.2	100	2	3RV2111-0EA10		1	1 unit	41E
0.5	0.12	0.35 ... 0.5	6.5	100	2	3RV2111-0FA10		1	1 unit	41E
0.63	0.18	0.45 ... 0.63	8.2	100	2	3RV2111-0GA10		1	1 unit	41E
0.8	0.18	0.55 ... 0.8	10	100	2	3RV2111-0HA10		1	1 unit	41E
1	0.25	0.7 ... 1	13	100	2	3RV2111-0JA10		1	1 unit	41E
1.25	0.37	0.9 ... 1.25	16	100	2	3RV2111-0KA10		1	1 unit	41E
1.6	0.55	1.1 ... 1.6	21	100	2	3RV2111-1AA10		1	1 unit	41E
2	0.75	1.4 ... 2	26	100	2	3RV2111-1BA10		1	1 unit	41E
2.5	0.75	1.8 ... 2.5	33	100	2	3RV2111-1CA10		1	1 unit	41E
3.2	1.1	2.2 ... 3.2	42	100	2	3RV2111-1DA10		1	1 unit	41E
4	1.5	2.8 ... 4	52	100	2	3RV2111-1EA10		1	1 unit	41E
5	1.5	3.5 ... 5	65	100	2	3RV2111-1FA10		1	1 unit	41E
6.3	2.2	4.5 ... 6.3	82	100	2	3RV2111-1GA10		1	1 unit	41E
8	3	5.5 ... 8	104	100	2	3RV2111-1HA10		1	1 unit	41E
10	4	7 ... 10	130	100	2	3RV2111-1JA10		1	1 unit	41E
12.5	5.5	9 ... 12.5	163	100	2	3RV2111-1KA10		1	1 unit	41E
16	7.5	10 ³⁾ ... 16	208	55	2	3RV2111-4AA10		1	1 unit	41E
Size S0²⁾										
16	7.5	10 ³⁾ ... 16	208	55	2	3RV2121-4AA10		1	1 unit	41E
20	7.5	13 ³⁾ ... 20	260	55	2	3RV2121-4BA10		1	1 unit	41E
22	11	16 ³⁾ ... 22	286	55	2	3RV2121-4CA10		1	1 unit	41E
25	11	18 ³⁾ ... 25	325	55	2	3RV2121-4DA10		1	1 unit	41E
28	15	23 ... 28	364	55	2	3RV2121-4NA10		1	1 unit	41E
32 ⁴⁾	15	27 ... 32	400	55	2	3RV2121-4EA10		1	1 unit	41E
Size S2²⁾										
14	5.5	9.5 ... 14	208	65	2	3RV2131-4SA10		1	1 unit	41E
17	7.5	12 ... 17	260	65	2	3RV2131-4TA10		1	1 unit	41E
20	7.5	14 ... 20	260	65	2	3RV2131-4BA10		1	1 unit	41E
25	11	18 ... 25	325	65	2	3RV2131-4DA10		1	1 unit	41E
32	15	22 ... 32	416	65	2	3RV2131-4EA10		1	1 unit	41E
36	18.5	28 ... 36	520	65	2	3RV2131-4PA10		1	1 unit	41E
40	18.5	32 ... 40	585	65	2	3RV2131-4UA10		1	1 unit	41E
45	22	35 ... 45	650	65	2	3RV2131-4VA10		1	1 unit	41E
52	32	42 ... 52	741	65	2	3RV2131-4WA10		1	1 unit	41E
59	30	49 ... 59	845	65	2	3RV2131-4XA10		1	1 unit	41E
65	30	54 ... 65	845	65	2	3RV2131-4JA10		1	1 unit	41E
73	37	62 ... 73	949	65	2	3RV2131-4KA10		1	1 unit	41E
80 ⁵⁾	37	70 ... 80	1 040	65	2	3RV2131-4RA10		1	1 unit	41E

¹⁾ Guide value for 4-pole standard motors at 50 Hz 400 V AC. The actual starting and rated data of the motor to be protected must be considered when selecting the units.

²⁾ Accessories for mounting on the right and 3RV2915 three-phase busbars cannot be used.

³⁾ The setting range of the thermal overload releases has been extended.

⁴⁾ Suitable for use with IE3/IE4 motors up to a starting current of 256 A. For higher starting currents we recommend using 3RV2 motor starter protectors size S2.

⁵⁾ Suitable for use with IE3/IE4 motors up to a starting current of 720 A. For higher starting currents we recommend using 3RV2 motor starter protectors size S3.

Auxiliary switches and other accessories can be ordered separately (see "Accessories" page 7/38 onwards).

Motor Starter Protectors/Circuit Breakers SIRIUS 3RV2 Motor Starter Protectors/Circuit Breakers

IE3/IE4 ready For motor protection with overload relay function

CLASS 10, with overload relay function (automatic RESET), without auxiliary switches (continued)

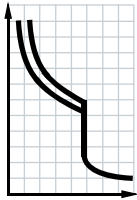

3RV2111-4FA10



3RV2111-0BA10



3RV2131-4WB10



3RV2142-4FA10

Rated current	Suitable for three-phase motors ¹⁾ with P	Setting range for thermal overload release	Instantaneous overcurrent release	Short-circuit breaking capacity at 400 V AC	SD	Screw terminals	⊕	PU (UNIT, SET, M)	PS*	PG
I_n				I_{cu}	d	Article No.	Price per PU			
A	kW	A	A	kA						
Size S3, with increased switching capacity²⁾ NEW										
40	18.5	28 ... 40	520	100	2	3RV2142-4FA10		1	1 unit	41E
50	22	36 ... 50	650	100	2	3RV2142-4HA10		1	1 unit	41E
63	30	45 ... 63	819	100	2	3RV2142-4JA10		1	1 unit	41E
75	37	57 ... 75	975	100	2	3RV2142-4KA10		1	1 unit	41E
84	45	65 ... 84	1 170	100	2	3RV2142-4RA10		1	1 unit	41E
93	45	75 ... 93	1 300	100	2	3RV2142-4YA10		1	1 unit	41E
100	45, 55	80 ... 100	1 300	100	2	3RV2142-4MA10		1	1 unit	41E

¹⁾ Guide value for 4-pole standard motors at 50 Hz 400 V AC. The actual starting and rated data of the motor to be protected must be considered when selecting the units.

²⁾ Accessories for mounting on the right and 3RV2915 three-phase busbars cannot be used.

Auxiliary switches and other accessories can be ordered separately (see "Accessories" page 7/38 onwards).



Motor Starter Protectors/Circuit Breakers

SIRIUS 3RV2 Motor Starter Protectors/Circuit Breakers

For starter combinations **IE3/IE4 ready**

Selection and ordering data

Without auxiliary switches

PU (UNIT, SET, M) = 1
 PS* = 1 unit
 PG = 41E

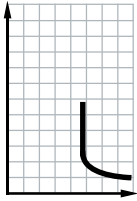

3RV2311-4AC10



3RV2311-0JC20



3RV2321-4AC10



3RV2321-4AC20

Rated current I_n A	Suitable for three-phase motors ¹⁾ with P kW	Thermal overload releases ²⁾ A	Instantaneous overcurrent release $I >$ A	Short-circuit breaking capacity at 400 V AC I_{cu} kA	SD d	Screw terminals		Spring-type terminals	
						Article No.	Price per PU	Article No.	Price per PU
Size S00									
0.16	0.04	Without	2.1	100	5	3RV2311-0AC10	5	3RV2311-0AC20	5
0.2	0.06	Without	2.6	100	5	3RV2311-0BC10	5	3RV2311-0BC20	5
0.25	0.06	Without	3.3	100	5	3RV2311-0CC10	5	3RV2311-0CC20	5
0.32	0.09	Without	4.2	100	5	3RV2311-0DC10	5	3RV2311-0DC20	5
0.4	0.09	Without	5.2	100	5	3RV2311-0EC10	5	3RV2311-0EC20	5
0.5	0.12	Without	6.5	100	5	3RV2311-0FC10	5	3RV2311-0FC20	5
0.63	0.18	Without	8.2	100	5	3RV2311-0GC10	5	3RV2311-0GC20	5
0.8	0.18	Without	10	100	5	3RV2311-0HC10	5	3RV2311-0HC20	5
1	0.25	Without	13	100	5	3RV2311-0JC10	5	3RV2311-0JC20	5
1.25	0.37	Without	16	100	5	3RV2311-0KC10	5	3RV2311-0KC20	5
1.6	0.55	Without	21	100	5	3RV2311-1AC10	5	3RV2311-1AC20	5
2	0.75	Without	26	100	5	3RV2311-1BC10	5	3RV2311-1BC20	5
2.5	0.75	Without	33	100	5	3RV2311-1CC10	5	3RV2311-1CC20	5
3.2	1.1	Without	42	100	5	3RV2311-1DC10	5	3RV2311-1DC20	5
4	1.5	Without	52	100	5	3RV2311-1EC10	5	3RV2311-1EC20	5
5	1.5	Without	65	100	5	3RV2311-1FC10	5	3RV2311-1FC20	5
6.3	2.2	Without	82	100	5	3RV2311-1GC10	5	3RV2311-1GC20	5
8	3	Without	104	100	5	3RV2311-1HC10	5	3RV2311-1HC20	5
10	4	Without	130	100	5	3RV2311-1JC10	5	3RV2311-1JC20	5
12.5	5.5	Without	163	100	5	3RV2311-1KC10	5	3RV2311-1KC20	5
16	7.5	Without	208	55	5	3RV2311-4AC10	5	3RV2311-4AC20	5
Size S0									
1.6	0.55	Without	21	100	5	3RV2321-1AC10	5	3RV2321-1AC20	5
2	0.75	Without	26	100	5	3RV2321-1BC10	5	3RV2321-1BC20	5
2.5	0.75	Without	33	100	5	3RV2321-1CC10	5	3RV2321-1CC20	5
3.2	1.1	Without	42	100	5	3RV2321-1DC10	5	3RV2321-1DC20	5
4	1.5	Without	52	100	5	3RV2321-1EC10	5	3RV2321-1EC20	5
5	1.5	Without	65	100	5	3RV2321-1FC10	5	3RV2321-1FC20	5
6.3	2.2	Without	82	100	5	3RV2321-1GC10	5	3RV2321-1GC20	5
8	3	Without	104	100	5	3RV2321-1HC10	5	3RV2321-1HC20	5
10	4	Without	130	100	5	3RV2321-1JC10	5	3RV2321-1JC20	5
12.5	5.5	Without	163	100	5	3RV2321-1KC10	5	3RV2321-1KC20	5
16	7.5	Without	208	55	5	3RV2321-4AC10	5	3RV2321-4AC20	5
20	7.5	Without	260	55	5	3RV2321-4BC10	5	3RV2321-4BC20	5
22	11	Without	286	55	5	3RV2321-4CC10	5	3RV2321-4CC20	5
25	11	Without	325	55	5	3RV2321-4DC10	5	3RV2321-4DC20	5
28	15	Without	364	55	5	3RV2321-4NC10	5	3RV2321-4NC20	5
32 ³⁾	15	Without	400	55	5	3RV2321-4EC10	5	3RV2321-4EC20	5
36 ⁴⁾	18.5	Without	432	20	5	3RV2321-4PC10		--	
40 ⁴⁾	18.5	Without	480	20	5	3RV2321-4FC10		--	

¹⁾ Guide value for 4-pole standard motors at 50 Hz 400 V AC. The actual starting and rated data of the motor to be protected must be considered when selecting the units.

²⁾ For overload protection of the motors, appropriate overload relays must be used.

³⁾ Suitable for use with IE3/IE4 motors up to a starting current of 256 A. For higher starting currents we recommend using 3RV2 motor starter protectors size S2.

⁴⁾ The devices must not be mounted side-by-side and they must not be assembled with link modules with contactors. A lateral clearance of 9 mm is required. For use with IE3/IE4 motors we recommend using 3RV2 motor starter protectors size S2.

Sizes S2 and S3 see page 7/33.

Auxiliary switches and other accessories can be ordered separately (see "Accessories" page 7/38 onwards).

Motor Starter Protectors/Circuit Breakers

SIRIUS 3RV2 Motor Starter Protectors/Circuit Breakers

IE3/IE4 ready For starter combinations

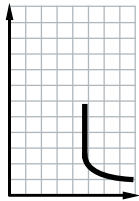
Without auxiliary switches (continued)

Rated current	Suitable for three-phase motors ¹⁾ with P	Thermal overload releases ²⁾	Instantaneous overcurrent release	Short-circuit breaking capacity at 400 V AC	SD	Screw terminals	PU (UNIT, SET, M)	PS*	PG
I_n				I_{cu}		Article No.	Price per PU		
A	kW	A	A	kA	d				
Size S2									
14	5.5	Without	208	65	2	3RV2331-4SC10		1	1 unit 41E
17	7.5	Without	260	65	2	3RV2331-4TC10		1	1 unit 41E
20	7.5	Without	260	65	2	3RV2331-4BC10		1	1 unit 41E
25	11	Without	325	65	2	3RV2331-4DC10		1	1 unit 41E
32	15	Without	416	65	2	3RV2331-4EC10		1	1 unit 41E
36	18.5	Without	520	65	2	3RV2331-4PC10		1	1 unit 41E
40	18.5	Without	585	65	2	3RV2331-4UC10		1	1 unit 41E
45	22	Without	650	65	2	3RV2331-4VC10		1	1 unit 41E
52	22	Without	741	65	2	3RV2331-4WC10		1	1 unit 41E
59	30	Without	845	65	2	3RV2331-4XC10		1	1 unit 41E
65	30	Without	845	65	2	3RV2331-4JC10		1	1 unit 41E
73	37	Without	949	65	2	3RV2331-4KC10		1	1 unit 41E
80 ³⁾	37	Without	1 040	65	2	3RV2331-4RC10		1	1 unit 41E
Size S2, with increased switching capacity									
14	5.5	Without	208	100	2	3RV2332-4SC10		1	1 unit 41E
17	7.5	Without	260	100	2	3RV2332-4TC10		1	1 unit 41E
20	7.5	Without	260	100	2	3RV2332-4BC10		1	1 unit 41E
25	11	Without	325	100	2	3RV2332-4DC10		1	1 unit 41E
32	15	Without	416	100	2	3RV2332-4EC10		1	1 unit 41E
36	18.5	Without	520	100	2	3RV2332-4PC10		1	1 unit 41E
40	18.5	Without	585	100	2	3RV2332-4UC10		1	1 unit 41E
45	22	Without	650	100	2	3RV2332-4VC10		1	1 unit 41E
52	22	Without	741	100	2	3RV2332-4WC10		1	1 unit 41E
59	30	Without	845	100	2	3RV2332-4XC10		1	1 unit 41E
65	30	Without	845	100	2	3RV2332-4JC10		1	1 unit 41E
73	37	Without	949	100	2	3RV2332-4KC10		1	1 unit 41E
80 ³⁾	37	Without	1 040	100	2	3RV2332-4RC10		1	1 unit 41E
Size S3 NEW									
40	18.5	Without	520	65	2	3RV2341-4FC10		1	1 unit 41E
50	22	Without	650	65	2	3RV2341-4HC10		1	1 unit 41E
63	30	Without	819	65	2	3RV2341-4JC10		1	1 unit 41E
75	37	Without	975	65	2	3RV2341-4KC10		1	1 unit 41E
84	45	Without	1 170	65	2	3RV2341-4RC10		1	1 unit 41E
93	45	Without	1 300	65	2	3RV2341-4YC10		1	1 unit 41E
100	45, 55	Without	1 300	65	2	3RV2341-4MC10		1	1 unit 41E
Size S3, with increased switching capacity NEW									
40	18.5	Without	520	100	2	3RV2342-4FC10		1	1 unit 41E
50	22	Without	650	100	2	3RV2342-4HC10		1	1 unit 41E
63	30	Without	819	100	2	3RV2342-4JC10		1	1 unit 41E
75	37	Without	975	100	2	3RV2342-4KC10		1	1 unit 41E
84	45	Without	1 170	100	2	3RV2342-4RC10		1	1 unit 41E
93	45	Without	1 300	100	2	3RV2342-4YC10		1	1 unit 41E
100	45, 55	Without	1 300	100	2	3RV2342-4MC10		1	1 unit 41E

¹⁾ Guide value for 4-pole standard motors at 50 Hz 400 V AC. The actual starting and rated data of the motor to be protected must be considered when selecting the units.

²⁾ For overload protection of the motors, appropriate overload relays must be used.

³⁾ Suitable for use with IE3/IE4 motors up to a starting current of 720 A. For higher starting currents we recommend using 3RV2 motor starter protectors size S3.

Auxiliary switches and other accessories can be ordered separately (see "Accessories" page 7/38 onwards).

Motor Starter Protectors/Circuit Breakers

SIRIUS 3RV2 Motor Starter Protectors/Circuit Breakers

For transformer protection

Selection and ordering data

CLASS 10, without auxiliary switches

Motor starter protectors for the protection of transformers with high inrush current

PU (UNIT, SET, M) = 1
 PS* = 1 unit
 PG = 41E

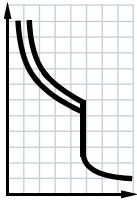

Rated current	Setting range for thermal overload release	Instantaneous overcurrent release	Short-circuit breaking capacity at 400 V AC	SD	Screw terminals	SD	Spring-type terminals
I_n		$I >$	I_{cu}	d	Article No.	Price per PU	Article No.
A	A	A	kA			d	Price per PU
Size S00							
0.16	0.11 ... 0.16	3.3	100	▶	3RV2411-0AA10	2	3RV2411-0AA20
0.2	0.14 ... 0.2	4.2	100	▶▶	3RV2411-0BA10	2	3RV2411-0BA20
0.25	0.18 ... 0.25	5.2	100	▶▶▶	3RV2411-0CA10	2	3RV2411-0CA20
0.32	0.22 ... 0.32	6.5	100	▶▶▶▶	3RV2411-0DA10	2	3RV2411-0DA20
0.4	0.28 ... 0.4	8.2	100	▶▶▶▶▶	3RV2411-0EA10	2	3RV2411-0EA20
0.5	0.35 ... 0.5	10	100	▶▶▶▶▶▶	3RV2411-0FA10	2	3RV2411-0FA20
0.63	0.45 ... 0.63	13	100	▶▶▶▶▶▶▶	3RV2411-0GA10	2	3RV2411-0GA20
0.8	0.55 ... 0.8	16	100	▶▶▶▶▶▶▶▶	3RV2411-0HA10	2	3RV2411-0HA20
1	0.7 ... 1	21	100	▶▶▶▶▶▶▶▶▶	3RV2411-0JA10	2	3RV2411-0JA20
1.25	0.9 ... 1.25	26	100	▶▶▶▶▶▶▶▶▶▶	3RV2411-0KA10	2	3RV2411-0KA20
1.6	1.1 ... 1.6	33	100	▶▶▶▶▶▶▶▶▶▶▶	3RV2411-1AA10	2	3RV2411-1AA20
2	1.4 ... 2	42	100	▶▶▶▶▶▶▶▶▶▶▶▶	3RV2411-1BA10	2	3RV2411-1BA20
2.5	1.8 ... 2.5	52	100	▶▶▶▶▶▶▶▶▶▶▶▶▶	3RV2411-1CA10	2	3RV2411-1CA20
3.2	2.2 ... 3.2	65	100	▶▶▶▶▶▶▶▶▶▶▶▶▶▶	3RV2411-1DA10	2	3RV2411-1DA20
4	2.8 ... 4	82	100	▶▶▶▶▶▶▶▶▶▶▶▶▶▶▶	3RV2411-1EA10	2	3RV2411-1EA20
5	3.5 ... 5	104	100	▶▶▶▶▶▶▶▶▶▶▶▶▶▶▶▶	3RV2411-1FA10	2	3RV2411-1FA20
6.3	4.5 ... 6.3	130	100	▶▶▶▶▶▶▶▶▶▶▶▶▶▶▶▶▶	3RV2411-1GA10	2	3RV2411-1GA20
8	5.5 ... 8	163	100	▶▶▶▶▶▶▶▶▶▶▶▶▶▶▶▶▶▶	3RV2411-1HA10	2	3RV2411-1HA20
10	7 ... 10	208	100	▶▶▶▶▶▶▶▶▶▶▶▶▶▶▶▶▶▶▶	3RV2411-1JA10	2	3RV2411-1JA20
12.5	9 ... 12.5	260	100	▶▶▶▶▶▶▶▶▶▶▶▶▶▶▶▶▶▶▶▶	3RV2411-1KA10	2	3RV2411-1KA20
16	10 ¹⁾ ... 16	286	55	▶▶▶▶▶▶▶▶▶▶▶▶▶▶▶▶▶▶▶▶▶	3RV2411-4AA10	2	3RV2411-4AA20
Size S0							
16	10 ¹⁾ ... 16	286	55	▶▶▶▶▶▶▶▶▶▶▶▶▶▶▶▶▶▶▶▶▶▶	3RV2421-4AA10	2	3RV2421-4AA20
20	13 ¹⁾ ... 20	325	55	▶▶▶▶▶▶▶▶▶▶▶▶▶▶▶▶▶▶▶▶▶▶▶	3RV2421-4BA10	2	3RV2421-4BA20
22	16 ¹⁾ ... 22	364	55	▶▶▶▶▶▶▶▶▶▶▶▶▶▶▶▶▶▶▶▶▶▶▶▶	3RV2421-4CA10	2	3RV2421-4CA20
25	18 ¹⁾ ... 25	400	55	▶▶▶▶▶▶▶▶▶▶▶▶▶▶▶▶▶▶▶▶▶▶▶▶▶	3RV2421-4DA10	2	3RV2421-4DA20
Size S2							
14	9.5 ... 14	328	65	▶▶▶▶▶▶▶▶▶▶▶▶▶▶▶▶▶▶▶▶▶▶▶▶	3RV2431-4SA10	---	---
17	12 ... 17	410	65	▶▶▶▶▶▶▶▶▶▶▶▶▶▶▶▶▶▶▶▶▶▶▶▶▶	3RV2431-4TA10	---	---
20	14 ... 20	410	65	▶▶▶▶▶▶▶▶▶▶▶▶▶▶▶▶▶▶▶▶▶▶▶▶▶▶	3RV2431-4BA10	---	---
25	18 ... 25	512	65	▶▶▶▶▶▶▶▶▶▶▶▶▶▶▶▶▶▶▶▶▶▶▶▶▶▶▶	3RV2431-4DA10	---	---
32	22 ... 32	656	65	▶▶▶▶▶▶▶▶▶▶▶▶▶▶▶▶▶▶▶▶▶▶▶▶▶▶▶▶	3RV2431-4EA10	---	---
36	28 ... 36	820	65	▶▶▶▶▶▶▶▶▶▶▶▶▶▶▶▶▶▶▶▶▶▶▶▶▶▶▶▶▶	3RV2431-4PA10	---	---
40	32 ... 40	820	65	▶▶▶▶▶▶▶▶▶▶▶▶▶▶▶▶▶▶▶▶▶▶▶▶▶▶▶▶▶▶	3RV2431-4UA10	---	---
45	35 ... 45	922	65	▶▶▶▶▶▶▶▶▶▶▶▶▶▶▶▶▶▶▶▶▶▶▶▶▶▶▶▶▶▶▶	3RV2431-4VA10	---	---
52	42 ... 52	1 025	65	▶▶▶▶▶▶▶▶▶▶▶▶▶▶▶▶▶▶▶▶▶▶▶▶▶▶▶▶▶▶▶▶	3RV2431-4WA10	---	---
59	49 ... 59	1 040	65	▶▶▶▶▶▶▶▶▶▶▶▶▶▶▶▶▶▶▶▶▶▶▶▶▶▶▶▶▶▶▶▶▶	3RV2431-4XA10	---	---
65	54 ... 65	1 040	65	▶▶▶▶▶▶▶▶▶▶▶▶▶▶▶▶▶▶▶▶▶▶▶▶▶▶▶▶▶▶▶▶▶▶	3RV2431-4JA10	---	---

¹⁾ The setting range of the thermal overload releases has been extended.

Auxiliary switches and other accessories can be ordered separately (see "Accessories" page 7/38 onwards).

Motor Starter Protectors/Circuit Breakers

SIRIUS 3RV2 Motor Starter Protectors/Circuit Breakers

For system protection according to UL 489/CSA C22.2 No. 5

Selection and ordering data

Without auxiliary switches

Circuit breakers for system protection and non-motor loads according to UL/CSA

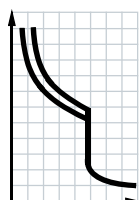

3RV2711-0AD10



3RV2742-5FD10

Rated current ¹⁾	Thermal overload release (non-adjustable)	Instantaneous overcurrent release	Short-circuit breaking capacity at 480 Y/277 V AC ²⁾	480 V AC	SD	Screw terminals	⊕	PU (UNIT, SET, M)	PS*	PG
I_n ¹⁾			I_{bc}		d	Article No.	Price per PU			
A	A	A	kA							
Size S00										
0.16	0.16	2.1	65	--	5	3RV2711-0AD10		1	1 unit	41E
0.2	0.2	2.6	65	--	5	3RV2711-0BD10		1	1 unit	41E
0.25	0.25	3.3	65	--	5	3RV2711-0CD10		1	1 unit	41E
0.32	0.32	4.2	65	--	5	3RV2711-0DD10		1	1 unit	41E
0.4	0.4	5.2	65	--	5	3RV2711-0ED10		1	1 unit	41E
0.5	0.5	6.5	65	--	5	3RV2711-0FD10		1	1 unit	41E
0.63	0.63	8.2	65	--	5	3RV2711-0GD10		1	1 unit	41E
0.8	0.8	10	65	--	5	3RV2711-0HD10		1	1 unit	41E
1	1	13	65	--	5	3RV2711-0JD10		1	1 unit	41E
1.25	1.25	16	65	--	5	3RV2711-0KD10		1	1 unit	41E
1.6	1.6	21	65	--	5	3RV2711-1AD10		1	1 unit	41E
2	2	26	65	--	5	3RV2711-1BD10		1	1 unit	41E
2.5	2.5	33	65	--	5	3RV2711-1CD10		1	1 unit	41E
3.2	3.2	42	65	--	5	3RV2711-1DD10		1	1 unit	41E
4	4	52	65	--	5	3RV2711-1ED10		1	1 unit	41E
5	5	65	65	--	5	3RV2711-1FD10		1	1 unit	41E
6.3	6.3	82	65	--	5	3RV2711-1GD10		1	1 unit	41E
8	8	104	65	--	5	3RV2711-1HD10		1	1 unit	41E
10	10	130	65	--	5	3RV2711-1JD10		1	1 unit	41E
12.5	12.5	163	65	--	5	3RV2711-1KD10		1	1 unit	41E
15	15	208	65	--	5	3RV2711-4AD10		1	1 unit	41E
Size S0										
20	20	260	50	--	5	3RV2721-4BD10		1	1 unit	41E
22	22	286	50	--	5	3RV2721-4CD10		1	1 unit	41E
Size S3 NEW										
10	10	150	65	65	5	3RV2742-5AD10		1	1 unit	41E
15	15	225	65	65	5	3RV2742-5BD10		1	1 unit	41E
20	20	260	65	65	5	3RV2742-5CD10		1	1 unit	41E
25	25	325	65	65	5	3RV2742-5DD10		1	1 unit	41E
30	30	390	65	65	5	3RV2742-5ED10		1	1 unit	41E
35	35	455	65	--	5	3RV2742-5FD10		1	1 unit	41E
40	40	520	65	--	5	3RV2742-5GD10		1	1 unit	41E
45	45	585	65	--	5	3RV2742-5HD10		1	1 unit	41E
50	50	650	65	--	5	3RV2742-5JD10		1	1 unit	41E
60	60	780	65	--	5	3RV2742-5LD10		1	1 unit	41E
70	70	910	65	--	5	3RV2742-5QD10		1	1 unit	41E

¹⁾ Rated value 100 % according to UL 489 and IEC 60947-2 ("100 % rated breaker").

²⁾ Values for 600 Y/347 V AC, see page 7/16.

Lateral and transverse auxiliary switches can be ordered separately (see "Accessories" page 7/38 onwards)

Motor Starter Protectors/Circuit Breakers

SIRIUS 3RV2 Motor Starter Protectors/Circuit Breakers

For transformer protection according to UL 489/CSA C22.2 No.5

Selection and ordering data

Without auxiliary switches

Circuit breakers for system and transformer protection according to UL/CSA, specially designed for transformers with high inrush current

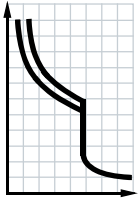

3RV2811-0AD10

Rated current ¹⁾	Thermal overload release (non-adjustable)	Instantaneous overcurrent release	Short-circuit breaking capacity at 480 Y/277 V AC ²⁾	SD	Screw terminals	⊕	PU (UNIT, SET, M)	PS*	PG
$I_n^{1)}$		$I >$	I_{bc}		Article No.	Price per PU			
A	A	A	kA	d					
Size S00									
0.16	0.16	3.3	65	5	3RV2811-0AD10		1	1 unit	41E
0.2	0.2	4.2	65	5	3RV2811-0BD10		1	1 unit	41E
0.25	0.25	5.2	65	5	3RV2811-0CD10		1	1 unit	41E
0.32	0.32	6.5	65	5	3RV2811-0DD10		1	1 unit	41E
0.4	0.4	8.2	65	5	3RV2811-0ED10		1	1 unit	41E
0.5	0.5	10	65	5	3RV2811-0FD10		1	1 unit	41E
0.63	0.63	13	65	5	3RV2811-0GD10		1	1 unit	41E
0.8	0.8	16	65	5	3RV2811-0HD10		1	1 unit	41E
1	1	21	65	5	3RV2811-0JD10		1	1 unit	41E
1.25	1.25	26	65	5	3RV2811-0KD10		1	1 unit	41E
1.6	1.6	33	65	5	3RV2811-1AD10		1	1 unit	41E
2	2	42	65	5	3RV2811-1BD10		1	1 unit	41E
2.5	2.5	52	65	5	3RV2811-1CD10		1	1 unit	41E
3.2	3.2	65	65	5	3RV2811-1DD10		1	1 unit	41E
4	4	82	65	5	3RV2811-1ED10		1	1 unit	41E
5	5	104	65	5	3RV2811-1FD10		1	1 unit	41E
6.3	6.3	130	65	5	3RV2811-1GD10		1	1 unit	41E
8	8	163	65	5	3RV2811-1HD10		1	1 unit	41E
10	10	208	65	5	3RV2811-1JD10		1	1 unit	41E
12.5	12.5	260	65	5	3RV2811-1KD10		1	1 unit	41E
15	15	286	65	5	3RV2811-4AD10		1	1 unit	41E
Size S0									
20	20	325	50	5	3RV2821-4BD10		1	1 unit	41E
22	22	364	50	5	3RV2821-4CD10		1	1 unit	41E

¹⁾ Rated value 100 % according to UL 489 and IEC 60947-2 ("100 % rated breaker").

²⁾ Values for 600 Y/347 V AC, see page 7/16.

Lateral and transverse auxiliary switches can be ordered separately (see "Accessories" page 7/38 onwards)

Motor Starter Protectors/Circuit Breakers

SIRIUS 3RV2 Motor Starter Protectors/Circuit Breakers

Accessories

Mountable accessories

Overview

Mounting location and function

The 3RV2 motor starter protectors/circuit breakers have three main contact elements. In order to achieve maximum flexibility, auxiliary switches, signaling switches, auxiliary releases and isolator modules can be supplied separately.

These components are easily fitted to the switches without the use of any tools according to requirements.

Overview graphic, [see page 7/7](#).

Front side Note: <ul style="list-style-type: none"> A maximum of four auxiliary contacts with auxiliary switches can be mounted on each motor starter protector/circuit breaker 	Transverse auxiliary switches, solid-state compatible transverse auxiliary switches 1 NO + 1 NC or 2 NO or 1 CO	An auxiliary switch block can be inserted transversely on the front. The overall width of the motor starter protectors/circuit breakers remains unchanged.
Left-hand side Notes: <ul style="list-style-type: none"> A maximum of four auxiliary contacts with auxiliary switches can be mounted on each motor starter protector/circuit breaker Lateral auxiliary switches (two contacts) and signaling switches can be mounted separately or together Signaling switches cannot be used for 3RV27 and 3RV28 circuit breakers 	Lateral auxiliary switches (2 contacts) 1 NO + 1 NC or 2 NO or 2 NC Lateral auxiliary switches (4 contacts) 2 NO + 2 NC	One of the three lateral auxiliary switches can be mounted on the left side per motor starter protector/circuit breaker. The contacts of the auxiliary switch close and open together with the main contacts of the motor starter protector/circuit breaker. The width of the lateral auxiliary switch with two contacts is 9 mm. One lateral auxiliary switch with four contacts can be mounted on the left side per motor starter protector/circuit breaker. The contacts of the auxiliary switch close and open together with the main contacts of the motor starter protector/circuit breaker. The width of the lateral auxiliary switch with four contacts is 18 mm.
	Signaling switches Tripping 1 NO + 1 NC Short circuit 1 NO + 1 NC	One signaling switch can be mounted on the left side of each motor starter protector. The signaling switch has two contact systems. One contact system always signals tripping irrespective of whether this was caused by a short circuit, an overload or an auxiliary release. The other contact system only switches in the event of a short circuit. There is no signaling as a result of switching off with the actuator. In order to be able to switch on the motor starter protector again after a short circuit, the signaling switch must be reset manually after the error cause has been eliminated. The width of the signaling switch is 18 mm.
Right-hand side Notes: <ul style="list-style-type: none"> One auxiliary release can be mounted per motor starter protector/circuit breaker Accessories cannot be mounted on the right-hand side of the 3RV21 motor starter protectors for motor protection with overload relay function 	Auxiliary releases Shunt releases or Undervoltage releases or Undervoltage releases with leading auxiliary contacts 2 NO	For remote-controlled tripping of the motor starter protector/circuit breaker. The release coil should only be energized for short periods (see circuit diagrams). or Trips the motor starter protector/circuit breaker when the voltage is interrupted and prevents the motor from being restarted accidentally when the voltage is restored. Used for remote-controlled tripping of the motor starter protector/circuit breaker. Particularly suitable for EMERGENCY-STOP disconnection by way of corresponding EMERGENCY-STOP pushbuttons according to EN 60204-1. or Function and use as for the undervoltage release without leading auxiliary contacts, but with the following additional function: the auxiliary contacts will open in switch position OFF to deenergize the coil of the undervoltage release, thus interrupting energy consumption. In the "tripped" position, these auxiliary contacts are not guaranteed to open. The leading contacts permit the motor starter protector/circuit breaker to reclose. The width of the auxiliary release is 18 mm.
Top Notes: <ul style="list-style-type: none"> Isolator modules cannot be used for 3RV27 and 3RV28 circuit breakers Isolator module for size S2: <ul style="list-style-type: none"> only with 3RV2 motor starter protectors/circuit breakers up to max. 65 A not with the transverse auxiliary switch Terminal screws of the transverse auxiliary switch are covered by the isolator module; Recommendation: Lateral auxiliary switches should be used in combination with the isolator module, or the isolator module should not be mounted until the auxiliary switch has been wired up 	Isolator modules	Isolator modules can be mounted to the upper connection side of the motor starter protectors. The supply cable is connected to the motor starter protector through the isolator module. The plug can only be unplugged when the motor starter protector is open and isolates all 3 poles of the motor starter protector from the network. The shock-protected isolation point is clearly visible and secured with a padlock to prevent reinsertion of the plug.

For a complete overview of which accessories can be used for the various motor starter protectors/circuit breakers, [see page 7/2](#).

Motor Starter Protectors/Circuit Breakers

SIRIUS 3RV2 Motor Starter Protectors/Circuit Breakers

Accessories

Mountable accessories

Selection and ordering data

PU (UNIT, SET, M) = 1
 PS* = 1 unit (unless otherwise specified)
 PG = 41E

Version	For motor starter protectors/circuit breakers	SD	Screw terminals 	SD 	Spring-type terminals 	
	Size	d	Article No.	Price per PU	Article No.	Price per PU
Auxiliary switches¹⁾						
 3RV2901-1E	Transverse auxiliary switches For mounting on the front 1 CO 1 NO + 1 NC 2 NO	S00 ... S3	▶	3RV2901-1D 3RV2901-1E 3RV2901-1F	▶	-- 3RV2901-2E 3RV2901-2F
 3RV2901-2E	Solid-state compatible transverse auxiliary switches For mounting on the front, for operation in dusty atmospheres and in solid-state circuits with low operating currents					
 3RV2901-1G	1 CO	S00 ... S3	2	3RV2901-1G		--
 3RV2901-0H	Covers for transverse auxiliary switches (PS* = 10 units)	S00 ... S3	▶	3RV2901-0H		--
 3RV2901-1A	Lateral auxiliary switches For mounting on the left 1 NO + 1 NC 2 NO 2 NC 2 NO + 2 NC	S00 ... S3	▶	3RV2901-1A 3RV2901-1B 3RV2901-1C 3RV2901-1J	▶	3RV2901-2A 3RV2901-2B 3RV2901-2C --
 3RV2901-2A						
Signaling switches²⁾						
 3RV2921-1M	Signaling switches One signaling switch can be mounted on the left per motor starter protector. Separate tripped and short-circuit alarms, 1 NO + 1 NC each	S00 ... S3	▶	3RV2921-1M	▶	3RV2921-2M
 3RV2921-2M						
Isolator modules²⁾						
 3RV2928-1A	Isolator modules³⁾ Visible isolating distance for isolating individual motor starter protectors from the network, lockable in disconnected position	S00, S0 S2 ⁴⁾	▶	3RV2928-1A 3RV2938-1A		-- --
 3RV2938-1A						

¹⁾ Each motor starter protector/circuit breaker can be fitted with one transverse and one lateral auxiliary switch. The lateral auxiliary switch with 2 NO + 2 NC is used without a transverse auxiliary switch.

²⁾ This accessory cannot be used for the 3RV27 and 3RV28 circuit breakers (sizes S00, S0, S3).

³⁾ The isolator module for size S2 can be used only with 3RV2 motor starter protectors/circuit breakers up to max. 65 A. Similarly, it cannot be used with the transverse auxiliary switch.

Motor Starter Protectors/Circuit Breakers SIRIUS 3RV2 Motor Starter Protectors/Circuit Breakers Accessories

Mountable accessories

PU (UNIT, SET, M) = 1
PS* = 1 unit
PG = 41E



3RV2902-1AV0



3RV2902-2AV0



3RV2922-1CP0



3RV2902-2DB0

Rated control supply voltage U_s						For motor starter protectors/circuit breakers	SD	Screw terminals		SD	Spring-type terminals	
AC 50 Hz	AC 60 Hz	AC 50/60 Hz	AC/DC 50/60 Hz, DC	DC	Size			d	Article No.		Price per PU	d
100 % ON period ¹⁾						5 s ON period ²⁾						
V	V	V	V	V	Size	d			d			
Auxiliary releases³⁾												
Undervoltage releases												
--	--	--	--	--	S00 ... S3	2	3RV2902-1AB4		--	3RV2902-2AP0		
24	--	--	--	24	S00 ... S3	2	3RV2902-1AB0		--	3RV2902-2AV0		
110	120	--	--	--	S00 ... S3	2	3RV2902-1AF0		--	3RV2902-2AV0		
--	208	--	--	--	S00 ... S3	2	3RV2902-1AM1		--	3RV2902-2AV0		
230	240	--	--	--	S00 ... S3	2	3RV2902-1AP0		--	3RV2902-2AV0		
400	440	--	--	--	S00 ... S3	2	3RV2902-1AV0		--	3RV2902-2AV0		
415	480	--	--	--	S00 ... S3	2	3RV2902-1AV1		--	3RV2902-2AV0		
500	600	--	--	--	S00 ... S3	2	3RV2902-1AS0		--	3RV2902-2AV0		
Undervoltage releases with leading auxiliary contacts 2 NO												
24	24	--	--	--	S00 ... S3	5	3RV2922-1CB0		--	3RV2922-2CP0		
230	240	--	--	--	S00 ... S3	2	3RV2922-1CP0		2	3RV2922-2CV0		
400	440	--	--	--	S00 ... S3	2	3RV2922-1CV0		2	3RV2922-2CV1		
415	480	--	--	--	S00 ... S3	2	3RV2922-1CV1		2	3RV2922-2CV1		
Shunt releases												
--	--	20 ... 24	20 ... 70	--	S00 ... S3	2	3RV2902-1DB0		--	3RV2902-2DB0		
--	--	90 ... 110	70 ... 190	--	S00 ... S3	2	3RV2902-1DF0		2	3RV2902-2DF0		
--	--	210 ... 240	190 ... 330	--	S00 ... S3	2	3RV2902-1DP0		2	3RV2902-2DP0		
--	--	350 ... 415	330 ... 500	--	S00 ... S3	2	3RV2902-1DV0		--	3RV2902-2DP0		
--	--	500	500	--	S00 ... S3	2	3RV2902-1DS0		--	3RV2902-2DP0		

¹⁾ The voltage range is valid for 100 % (infinite) ON period. The response voltage lies at 0.9 of the lower limit of the voltage range.
²⁾ The voltage range is valid for 5 s ON period at AC 50/60 Hz and DC. The response voltage lies at 0.85 of the lower limit of the voltage range.

³⁾ One auxiliary release can be mounted on the right per motor starter protector/circuit breaker (does not apply to 3RV21 motor starter protectors with overload relay function).

Motor Starter Protectors/Circuit Breakers

SIRIUS 3RV2 Motor Starter Protectors/Circuit Breakers

Accessories

Busbar accessories

Overview

Insulated three-phase busbar system

Three-phase busbar systems provide an easy, time-saving and clearly arranged means of feeding 3RV2 motor starter protectors/circuit breakers with screw terminals. Different versions are available for sizes S00 to S2 and can be used for the various different types of motor starter protectors/circuit breakers (size S0 up to 32 A).

The 3RV1915 and 3RV1935 three-phase busbar systems are generally unsuitable for the 3RV21 motor starter protectors for motor protection with overload relay function and 3RV27 and 3RV28 circuit breakers according to UL 489/CSA C22.2 No. 5.

The busbars are suitable for between two and five motor starter protectors/circuit breakers. However, any kind of extension is possible by clamping the tags of an additional busbar (rotated by 180°) underneath the terminals of the respective last motor starter protector/circuit breaker.

A combination of motor starter protectors/circuit breakers of size S00 and S0 is possible. The motor starter protectors/circuit breakers are supplied by appropriate infeed terminals.

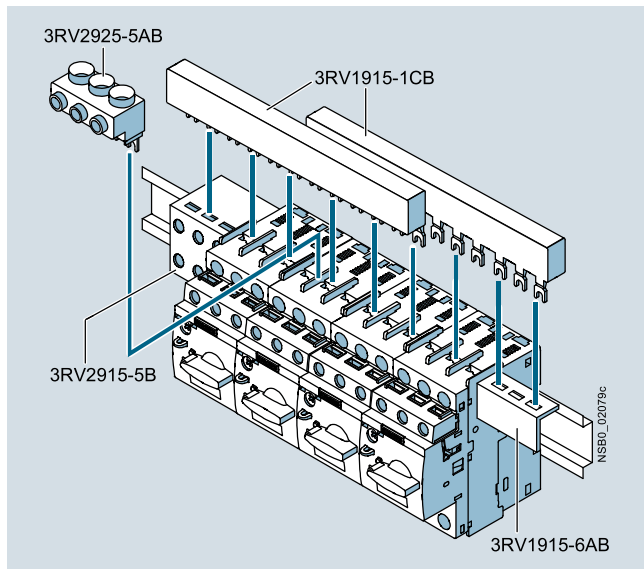

SIRIUS three-phase busbar system size S00/S0

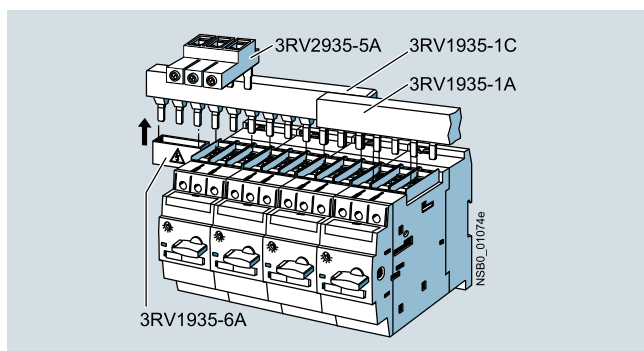

SIRIUS three-phase busbar system size S2

The three-phase busbar systems are finger-safe. They are designed for any short-circuit stress which can occur at the output side of connected motor starter protectors/circuit breakers.

The three-phase busbar systems can also be used to construct "Type E Starters" according to UL/CSA. Special infeed terminals must be used for this purpose, however (see "Selection and ordering data", page 7/41).

8US busbar adapters for 60 mm systems

The motor starter protectors/circuit breakers are mounted directly with the aid of busbar adapters on busbar systems with 60 mm center-to-center clearance in order to save space and to reduce infeed times and costs.

Busbar adapters for busbar systems with 60 mm center-to-center clearance are suitable for copper busbars with a width of 12 mm to 30 mm. The busbars can be 5 mm or 10 mm thick.

The motor starter protectors/circuit breakers are snapped onto the adapter and connected on the line side. This prepared unit is then plugged directly onto the busbar system, and is thus connected both mechanically and electrically at the same time.

For further busbar adapters for snap-mounting direct-on-line starters and reversing starters as well as additional accessories such as incoming and outgoing terminals, flat copper profile etc., see [Catalog LV 10](#).

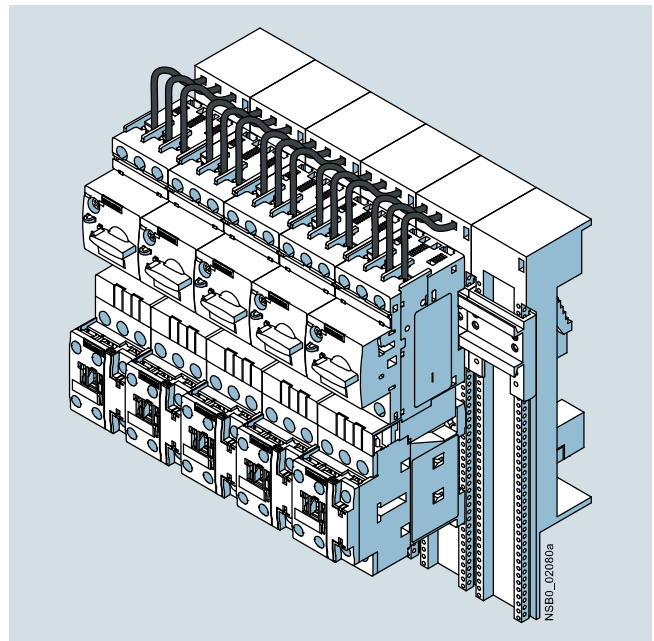

SIRIUS load feeders with busbar adapters snapped onto busbars





Motor Starter Protectors/Circuit Breakers

SIRIUS 3RV2 Motor Starter Protectors/Circuit Breakers

Accessories

Busbar accessories

Selection and ordering data

	Modular spacing mm	Number of motor starter protectors that can be connected			Rated current I_n at 690 V A	For motor starter protectors Size	SD d	Article No.	Price per PU	PU (UNIT, SET, M)	PS*	PG
		Without lateral accessories	With lateral auxiliary switch	incl. auxiliary release								
Three-phase busbars¹⁾												
For feeding several motor starter protectors with screw terminals, mounted side by side on standard mounting rails, insulated, with touch protection												
 3RV1915-1AB	45 ³⁾	2	--	--	63	S00, S0 ²⁾	▶	3RV1915-1AB		1	1 unit	41E
		3	--	--	63	S00, S0 ²⁾	▶	3RV1915-1BB		1	1 unit	41E
		4	--	--	63	S00, S0 ²⁾	▶	3RV1915-1CB		1	1 unit	41E
 3RV1915-1BB	55 ⁴⁾	--	2	--	63	S00, S0 ²⁾	▶	3RV1915-2AB		1	1 unit	41E
		--	3	--	63	S00, S0 ²⁾	▶	3RV1915-2BB		1	1 unit	41E
		--	4	--	63	S00, S0 ²⁾	▶	3RV1915-2CB		1	1 unit	41E
 3RV1915-1CB		--	5	--	63	S00, S0 ²⁾	▶	3RV1915-2DB		1	1 unit	41E
		2	--	--	108	S2	▶	3RV1935-1A		1	1 unit	41E
		3	--	--	108	S2	▶	3RV1935-1B		1	1 unit	41E
 3RV1915-1DB	63 ⁵⁾	--	--	2	63	S00, S0 ²⁾	▶	3RV1915-3AB		1	1 unit	41E
		--	--	4	63	S00, S0 ²⁾	▶	3RV1915-3CB		1	1 unit	41E
	75 ⁵⁾	--	2	2	108	S2	▶	3RV1935-3A		1	1 unit	41E
		--	3	3	108	S2	▶	3RV1935-3B		1	1 unit	41E
		--	4	4	108	S2	▶	3RV1935-3C		1	1 unit	41E



1) Not suitable for 3RV21 motor starter protectors for motor protection with overload relay function and for 3RV27 and 3RV28 circuit breakers according to UL 489/CSA C22.2 No.5.

2) Approved for motor starter protectors size S0 with $I_n \leq 32$ A.



3) For 3RV2 motor starter protectors without accessories mounted on the side.

4) For 3RV2 motor starter protectors with auxiliary switches with 1 NO + 1 NC, 2 NO and 2 NC mounted on the left (9 mm wide).

5) For 3RV2 motor starter protectors with mounted accessories (18 mm wide). Auxiliary switches with 2 NO + 2 NC or signaling switch (mounted on the left) or with auxiliary release (mounted on the right).

	Conductor cross-section			Tightening torque Nm	For motor starter protectors/circuit breakers Size	SD d	Article No.	Price per PU	PU (UNIT, SET, M)	PS*	PG
	Solid or stranded mm ²	Finely stranded with end sleeve mm ²	AWG cables, solid or stranded AWG								
Three-phase infeed terminals											
Connection from top											
 3RV2925-5AB	2.5 ... 25	2.5 ... 16	10 ... 4	3 ... 4	S00, S0	▶	3RV2925-5AB		1	1 unit	41E
	2 x (2.5 ... 50) ¹⁾ 1 x (2.5 ... 70) ¹⁾	2 x (2.5 ... 35) ¹⁾ 1 x (2.5 ... 50) ¹⁾	2 x (10 ... 1/0) ¹⁾ 1 x (10 ... 2/0) ¹⁾	4 ... 6	S2	▶	3RV2935-5A		1	1 unit	41E
 3RV2935-5A											
Connection from below											
Terminal is connected in place of a switch, take space requirement into account											
 3RV2915-5B	2.5 ... 25	2.5 ... 16	10 ... 4	Input: 4, Output: 2 ... 2.5	S00, S0	▶	3RV2915-5B		1	1 unit	41E

Three-phase infeed terminals for constructing "Type E Starters" "

Connection from top											
 3RV2925-5EB	2.5 ... 25	2.5 ... 16	10 ... 4	3 ... 4	S00, S0	2	3RV2925-5EB		1	1 unit	41E
	2 x (2.5 ... 50) ¹⁾ 1 x (2.5 ... 70) ¹⁾	2 x (2.5 ... 35) ¹⁾ 1 x (2.5 ... 50) ¹⁾	2 x (10 ... 1/0) ¹⁾ 1 x (10 ... 2/0) ¹⁾	4 ... 6	S2	▶	3RV2935-5E		1	1 unit	41E
 3RV2935-5E											

1) If two different conductor cross-sections are connected to one clamping point, both cross-sections must be in the range specified.

Motor Starter Protectors/Circuit Breakers

SIRIUS 3RV2 Motor Starter Protectors/Circuit Breakers

Accessories

Busbar accessories

Version	For motor starter protectors/circuit breakers	SD	Article No.	Price per PU	PU (UNIT, SET, M)	PS*	PG
	Size	d					

Covers for connection tags



3RV1915-6AB

Touch protection for empty positions

S00, S0

S2

▶ 3RV1915-6AB

1 10 units

41E

▶ 3RV1935-6A

1 5 units

41E

Busbar adapters



8US1251-5DS10



8US1251-5DT11



8US1250-5AS10



8US1250-5AT10



8US1211-4RT00

For motor starter protectors/circuit breakers	Rated current	Connecting cable	Adapter length	Adapter width	Rated voltage	SD	Article No.	Price per PU	PU (UNIT, SET, M)	PS*	PG
Size	A	AWG	mm	mm	V	d					

Busbar adapters for 60 mm systems

For copper busbars according to DIN 46433
Width: 12 mm and 30 mm
Thickness: 5 mm and 10 mm
also for T and double-T special profiles

- For motor starter protectors/circuit breakers with screw terminals

S00, S0 ²⁾	25	12	200	45	690	2	8US1251-5DS10		1	1 unit	140
S0 ²⁾	32	10	260	45	690	2	8US1251-5NT10		1	1 unit	140
S2	80	4	200	55	69	5	8US1261-5MS13		1	1 unit	140
S2	80	4	260	55	690	5	8US1261-6MT10		1	1 unit	140
S2 ¹⁾	80	4	260	118	690	5	8US1211-6MT10		1	1 unit	140
S3	100/70 ³⁾	4	215	72	690/600 ³⁾	2	8US1211-4TR00		1	1 unit	140

- For motor starter protectors/circuit breakers with spring-type terminals

S00, S0 ²⁾	25	12	200	45	690	2	8US1251-5DS11		1	1 unit	140
S00, S0 ²⁾	25	12	260	45	690	2	8US1251-5DT11		1	1 unit	140
S0 ²⁾	32	10	260	45	690	2	8US1251-5NT11		1	1 unit	140

Accessories

Device holders

For lateral mounting to busbar adapters

--	--	--	200	45	--	2	8US1250-5AS10		1	1 unit	140
--	--	--	260	45	--	2	8US1250-5AT10		1	1 unit	140

Side modules

For widening of busbar adapters

--	--	--	200	9	--	2	8US1998-2BJ10		1	10 units	140
----	----	----	-----	---	----	---	----------------------	--	---	----------	-----

Spacers

For fixing the feeder onto the busbar adapter

--	--	--	--	--	--	2	8US1998-1BA10		1	50 units	140
----	----	----	----	----	----	---	----------------------	--	---	----------	-----

Vibration and shock kits

For high vibration and shock loads

S00/S0	--	--	--	--	--	2	8US1998-1CA10		1	2 units	140
S2	--	--	--	--	--	5	8US1998-1DA10		1	1 unit	140

¹⁾ For the assembly of feeders for reversing starters comprising a motor starter protector and two contactors.

²⁾ Also approved for 3RV27, 3RV28 according to UL.

³⁾ Values according to UL/CSA:
-Rated current: 70 A at 600 V AC
-Short-circuit breaking capacity:
480 V AC: 65 kA, up to $I_n = 30$ A
480 Y/277 V AC: 65 kA
600 Y/347 V AC: 20 kA.

For additional busbar adapters, see [Catalog LV 10](#).

Motor Starter Protectors/Circuit Breakers

SIRIUS 3RV2 Motor Starter Protectors/Circuit Breakers

Accessories

Rotary operating mechanisms

Overview

Door-coupling rotary operating mechanisms

Motor starter protectors/circuit breakers with a rotary operating mechanism can be mounted in a control cabinet and operated externally by means of a door-coupling rotary operating mechanism. When the cabinet door with motor starter protector/circuit breaker is closed, the operating mechanism is coupled. When the motor starter protector/circuit breaker closes, the coupling is locked which prevents the door from being opened unintentionally. This interlock can be defeated by the maintenance personnel. In the OPEN position, the rotary operating mechanism can be secured against reclosing with up to three padlocks. Inadvertent opening of the door is not possible in this case either.

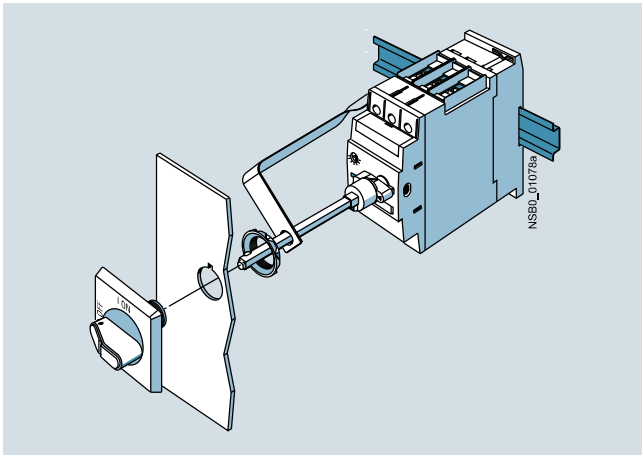

SIRIUS 3RV2926-0K door-coupling rotary operating mechanism

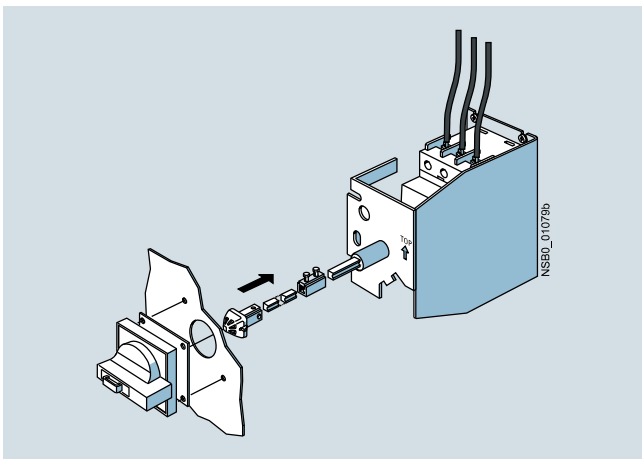

SIRIUS 3RV2926-2B door-coupling rotary operating mechanism for arduous conditions

Remote motorized operating mechanisms

3RV motor starter protectors are manually operated switching devices. They automatically trip in response to an overload or short circuit. Intentional remote-controlled tripping is possible by means of a shunt release or an undervoltage release. Reclosing is only possible directly at the motor starter protector/circuit breaker.

The remote motorized operating mechanism allows the motor starter protectors/circuit breakers to be opened and closed by electrical commands. This enables a load or an installation to be isolated from the network or reconnected to it from an operator panel.

If the motor starter protector/circuit breaker is tripped as a result of overload or short circuit, it will be in the tripped position. For reclosing, the remote motorized operating mechanism must first be set manually or electrically to the 0 position (electrically by means of the Open command). Then it can be reclosed.

The remote motorized operating mechanism is available for motor starter protectors/circuit breakers in size S3 for control voltages of 230 V AC and 24 V DC. The motor starter protector/circuit breaker is fitted into the remote motorized operating mechanism as shown in the drawing.

In the "MANUAL" position, the motor starter protector/circuit breaker in the remote motorized operating mechanism can continue to be switched manually on site. In the "AUTOMATIC" position, the motor starter protector/circuit breaker is switched by means of electrical commands. The switching command must be applied for a minimum of 100 ms. The remote motorized operating mechanism closes the motor starter protector after a maximum of 1 s. On voltage failure during the switching operation it is ensured that the motor starter protector/circuit breaker remains in the "OPEN" or "CLOSED" position. In the "MANUAL" and "OFF" position, the remote motorized operating mechanism can be locked with a padlock.

RESET function

The RESET button on the motorized operating mechanism serves to reset any 3RV2921-1M signaling switch that might be installed.

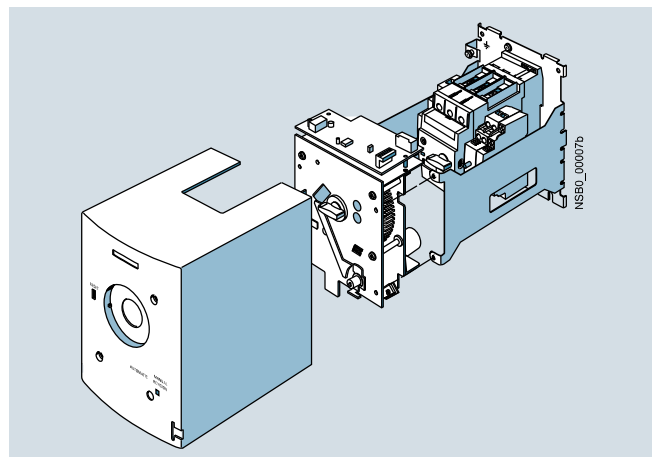

SIRIUS 3RV1946-3A.. remote motorized operating mechanism

Motor Starter Protectors/Circuit Breakers

SIRIUS 3RV2 Motor Starter Protectors/Circuit Breakers

Accessories

Rotary operating mechanisms

Technical specifications

Remote motorized operating mechanisms		
Type	3RV1946	
Max. power consumption		
• At $U_s = 24$ V DC	W	48
• At $U_s = 230$ V AC	VA	170
Operating range	0.85 ... 1.1 x U_s	
Minimum command duration at U_s	s	0.1
Max. command duration	Unlimited (uninterrupted operation)	
Max. total make/break time, remote-controlled	s	2
Ready to reclose after approx.	s	2.5
Switching frequency	1/h	25
Internal back-up fuse		
• 230 V AC	A	0.8
• 24 V DC	A	1.6
Connection type of control cables	Plug-in connectors with screw terminals	
Shock resistance acc. to IEC 60068-2-27	g/ms	25/11 (square and sine pulse)

Selection and ordering data

Version	Color of actuator	Version of extension shaft mm	For motor starter protectors/ circuit breakers Size	SD	Article No.	Price per PU	PU (UNIT, SET, M)	PS*	PG
---------	-------------------	----------------------------------	---	----	-------------	--------------	-------------------	-----	----

Door-coupling rotary operating mechanisms



3RV2926-0B

Door-coupling rotary operating mechanisms consisting of an actuator, a coupling driver and a 130/330 mm long extension shaft (6 mm x 6 mm)

Designed for degree of protection IP65; the door locking device prevents accidental opening of the control cabinet door when the switch is set to ON. The OFF position can be locked with up to three padlocks.

Door-coupling rotary operating mechanisms	Black	130 330	S00 ... S3 S00 ... S3	▶ ▶	3RV2926-0B 3RV2926-0K		1 1	1 unit 1 unit	41E 41E
EMERGENCY-STOP door-coupling rotary operating mechanisms	Red/yellow	130 330	S00 ... S3 S00 ... S3	▶ ▶	3RV2926-0C 3RV2926-0L		1 1	1 unit 1 unit	41E 41E

Door-coupling rotary operating mechanisms for arduous conditions



3RV2926-2B

The door-coupling rotary operating mechanisms consist of an actuator, a coupling driver, an extension shaft of 300 mm in length (8 mm x 8 mm), a spacer and two metal brackets into which the motor starter protector/circuit breaker is inserted.

The door-coupling rotary operating mechanisms are designed to degree of protection IP65. The door interlocking reliably prevents opening of the control cabinet door in the ON position of the motor starter protector/circuit breaker. The OFF position can be locked with up to three padlocks.

Laterally mountable auxiliary releases and two-pole auxiliary switches can be used.

The door-coupling rotary operating mechanisms thus meet the requirements for isolating functions according to IEC 60947-2.

Door-coupling rotary operating mechanisms	Gray	300	S00, S0 S2	▶ ▶	3RV2926-2B 3RV2936-2B		1 1	1 unit 1 unit	41E 41E
EMERGENCY-STOP door-coupling rotary operating mechanisms	Red/yellow	300	S00, S0 S2 S3	▶ ▶ ▶	3RV2946-2B 3RV2926-2C 3RV2936-2C 3RV2946-2C		1 1 1 1	1 unit 1 unit 1 unit 1 unit	41E 41E 41E 41E



3RV2936-2C

Version	Rated control supply voltage U_s	For motor starter protectors/ circuit breakers Size	SD	Article No.	Price per PU	PU (UNIT, SET, M)	PS*	PG
---------	------------------------------------	---	----	-------------	--------------	-------------------	-----	----

Remote motorized operating mechanisms



3RV1946-3A...

Remote motorized operating mechanisms	50/60 Hz, 230 V AC 24 V DC	S3 S3	X X	3RV1946-3AP0 3RV1946-3AB4		1 1	1 unit 1 unit	41E 41E
--	-------------------------------	----------	--------	--	--	--------	------------------	------------

Motor Starter Protectors/Circuit Breakers

SIRIUS 3RV2 Motor Starter Protectors/Circuit Breakers

Accessories

Mounting accessories

Overview

More information

System Manual "SIRIUS – System Overview", see <https://support.industry.siemens.com/cs/ww/en/view/60311318>

Manual "SIRIUS – SIRIUS 3RV2 Motor Starter Protectors", see <https://support.industry.siemens.com/cs/ww/en/view/60279172>

Accessories for "Self-Protected Combination Motor Controllers (Type E)" according to UL 508/UL 60947-4-1

The 3RV20 motor starter protectors with screw terminals are approved according to UL 508/UL 60947-4-1 as "Self-Protected Combination Motor Controllers (Type E)".

This requires increased through air and over surface spacing (1 inch and 2 inches respectively) at the input side of the device, which are achieved by mounting a terminal block or a phase barrier.

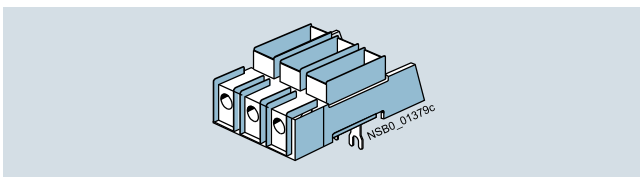

SIRIUS 3RV2928-1H terminal block

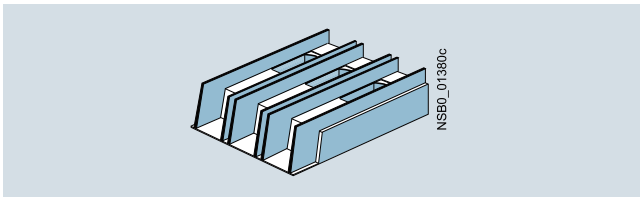

SIRIUS 3RT2946-4GA07 terminal block (type E)

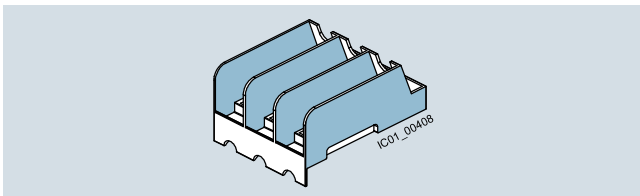

SIRIUS 3RV2928-1K phase barrier

Motor starter protectors/circuit breakers	Size	Essential accessories for "Self-Protected Combination Motor Controllers (Type E)" according to UL 508/UL 60947-4-1
3RV201., 3RV202.	S00/S0	3RV2928-1H terminal block or 3RV2928-1K phase barrier
3RV2031-4B.1., 3RV2031-4D.1., 3RV2031-4E.1., 3RV2031-4P.1., 3RV2031-4S.1., 3RV2031-4T.1., 3RV2031-4U.1., 3RV2031-4V.1.	S2	--
3RV2031-4J.1., 3RV2031-4K.1., 3RV2031-4R.1., 3RV2031-4W.1., 3RV2031-4X.1., 3RV2032	S2	3RV2938-1K phase barrier
3RV204.	S3	3RT2946-4GA07 terminal block

-- No accessories needed

Special three-phase infeed terminals are required for constructing "Type E Starters" with an insulated three-phase busbar system (see "Busbar Accessories", page 7/41).

The 3RV29 infeed system also enables the assembly of "Type E Starters", see page 7/55 onwards.

Note:

According to CSA, these terminal blocks and the phase barriers can be omitted when the device is used as a "Self-Protected Combination Motor Controller (Type E)".

Motor Starter Protectors/Circuit Breakers

SIRIUS 3RV2 Motor Starter Protectors/Circuit Breakers

Accessories

Mounting accessories

Link modules

Feeders can be easily assembled from single devices with the help of the link modules. The following table shows the different combination options for devices with screw or spring-type terminals.

Combination devices	3RV2 motor starter protectors/circuit breakers Size	3RT2 contactors; 3RW30, 3RW40 soft starters; 3RF34 solid-state contactors Size	Link modules	
			Screw terminals	Spring-type terminals
Link modules for connecting switching devices to 3RV2 motor starter protectors/circuit breakers¹⁾				
3RT2 contactors with AC or DC coil	S00	S00	3RA1921-1DA00	3RA2911-2AA00
	S0	S00		--
	S2	S2	3RA2931-1AA00	--
	S3 ²⁾	S3 ²⁾	3RA1941-1AA00	--
3RT2 contactors with AC coil	S0	S0	3RA2921-1AA00	3RA2921-2AA00 ³⁾
	S00	S0		--
3RT2 contactors with DC coil	S0	S0	3RA2921-1BA00	3RA2921-2AA00
	S00	S0		--
3RW30 soft starters	S00	S00	3RA2921-1BA00	3RA2911-2GA00
	S0	S00		--
3RW30/3RW40 soft starters	S0	S0	3RA2921-1BA00	3RA2921-2GA00
	S00	S0		--
	S2 ⁴⁾	S2 ⁴⁾	3RA2931-1AA00	--
	S3 ⁵⁾	S3 ⁵⁾	3RA1941-1AA00	--
3RF34 solid-state contactors	S00/S0	S00	3RA2921-1BA00	--
Hybrid link modules for connecting contactors with spring-type terminals to 3RV2 motor starter protectors/circuit breakers with screw terminals⁶⁾				
3RT2 contactors with AC or DC coil	S00	S00	3RA2911-2FA00	--
	S0	S0	3RA2921-2FA00	--

-- Version not possible

- 1) The link modules cannot be used for 3RV2.21-4PA1., 3RV2.21-4FA1., 3RV2.31-4K.1., 3RV2.31-4R.1., 3RV2.32-4K.1., 3RV2.32-4R.1., 3RV27 and 3RV28 motor starter protectors/circuit breakers.
- 2) To assemble the feeder between a motor starter protector and a contactor in size S3, the 3RA2942-1A00 standard mounting rail adapter must be used.
- 3) A spacer for height compensation on AC contactors, size S0, is optionally available, see page 7/49.
- 4) To assemble the feeder between a motor starter protector and a soft starter in size S2, the 3RA2932-1CA00 standard mounting rail adapter must be used.
- 5) It is only permissible to assemble the feeder between the motor starter protector and the soft starter in size S3 on a mounting plate.
- 6) The motor starter protector to contactor hybrid link modules cannot be used for the 3RV2.21-4PA1., 3RV2.21-4FA1., 3RV27 and 3RV28 motor starter protectors/circuit breakers. They are suitable only for constructing direct-on-line starters.

Note:

- Link modules can be used in
 - Sizes S00 and S0: up to max. 32 A
 - Size S2: up to max. 65 A
- Hybrid link modules can be used in
 - Sizes S00 and S0: up to max. 32 A

Motor Starter Protectors/Circuit Breakers





SIRIUS 3RV2 Motor Starter Protectors/Circuit Breakers

Accessories

Mounting accessories

Selection and ordering data

Accessories

Version	For motor starter protectors/circuit breakers	SD	Article No.	Price per PU	PU (UNIT, SET, M)	PS*	PG
	Size	d					
Covers							
	Terminal covers For cable lug and busbar connection for maintaining the required voltage clearances and as touch protection if box terminal is removed (2 units can be mounted per motor starter protector/circuit breaker)	S3	5	3RT1946-4EA1	1	1 unit	41B
3RV2 (size S3) with 3RT1946-4EA1 (left)							
	Scale covers Sealable, for covering the set current scale	3RV20, 3RV21, 3RV24; S00 ... S3	▶	3RV2908-0P	100	10 units	41E
3RV2908-0P							
	Covers for devices with screw terminals (box terminals) Additional touch protection for fastening to the box terminals (2 units required per device) • Main current level	S2	2	3RT2936-4EA2	1	1 unit	41B
3RT2936-4EA2							
		S3	NEW ▶	3RT2946-4EA2	1	1 unit	41B
Fixing accessories							
	Push-in lugs For screwing the motor starter protector onto mounting plates Two units are required for each motor starter protector.	S00, S0	2	3RV2928-0B	100	10 units	41E
3RV2928-0B							
Tools for opening spring-type terminals							
	Screwdrivers For all SIRIUS devices with spring-type terminals Length, approx. 200 mm, 3.0 mm x 0.5 mm, titanium gray/black, partially insulated	S00 ... S3	2	3RA2908-1A	1	1 unit	41B
3RA2908-1A							

Motor Starter Protectors/Circuit Breakers

SIRIUS 3RV2 Motor Starter Protectors/Circuit Breakers

Accessories

Mounting accessories

Version	For motor starter protectors/ circuit breakers	SD	Article No.	Price per PU	PU (UNIT, SET, M)	PS*	PG
	Size	d					

Terminal blocks and phase barriers for "Self-Protected Combination Motor Controllers (Type E)" according to UL 508/UL 60947-4-1

Note:

UL 508/UL 60947-4-1 approval demands 1-inch through air spacing and 2-inch over surface spacing for "Self-Protected Combination Motor Controllers (Type E)". The following terminal blocks or phase barriers must be used for the 3RV20 motor starter protectors with screw terminals. 3RV20 motor starter protectors with spring-type terminals must be assembled with the 3RV29 infeed system for approval as "Self-Protected Combination Motor Controllers (Type E)" according to UL 508/UL 60947-4-1.

The terminal block or phase barriers cannot be used in combination with the 3RV19.5 three-phase busbars.

For construction with three-phase busbars, see "Busbar Accessories", page 7/40 onwards.



3RV2928-1H



3RT2946-4GA07

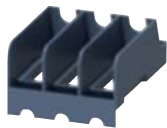

3RV2928-1K



3RV2938-1K

Terminal blocks type E
For extended clearances
(1 and 2 inch)

S00, S0
S3 **NEW** 3

▶ **3RV2928-1H**
▶ **3RT2946-4GA07**

1 1 unit 41E
1 1 unit 41B

Phase barriers
For extended clearances
(1 and 2 inch)

S00, S0
S2

▶ **3RV2928-1K**
▶ **3RV2938-1K**

1 1 unit 41E
1 1 unit 41E

Auxiliary terminals, 3-pole



3RT2946-4F

For connection of auxiliary and control
cables to the main conductor connections
(for one side)

S3 **NEW** 5

▶ **3RT2946-4F**

1 1 unit 41B

Motor Starter Protectors/Circuit Breakers

SIRIUS 3RV2 Motor Starter Protectors/Circuit Breakers



Accessories

Mounting accessories

Link modules

Actuating voltage of contactor	Size	3RV2 motor starter protectors/circuit breakers	SD	Article No.	Price per PU	PU (UNIT, SET, M)	PS*	PG
--------------------------------	------	--	----	-------------	--------------	-------------------	-----	----

Link modules for motor starter protector to contactor¹⁾

				Screw terminals 				
For electrical and mechanical connection between motor starter protector and contactor with screw terminals								
Single-unit packaging								
AC/DC	S00	S00/S0	▶	3RA1921-1DA00		1	1 unit	41B
AC	S0	S00/S0	▶	3RA2921-1AA00		1	1 unit	41B
DC	S0	S00/S0	▶	3RA2921-1BA00		1	1 unit	41B
AC/DC	S2	S2	▶	3RA2931-1AA00		1	1 unit	41B
AC/DC	S3	S3	▶	3RA1941-1AA00		1	1 unit	41B
Multi-unit packaging								
AC/DC	S00	S00/S0	▶	3RA1921-1D		1	10 units	41B
AC	S0	S00/S0	▶	3RA2921-1A		1	10 units	41B
DC	S0	S00/S0	▶	3RA2921-1B		1	10 units	41B
AC/DC	S2	S2	▶	3RA2931-1A		1	5 units	41B
AC/DC	S3	S3	▶	3RA1941-1A		1	5 units	41B
				Spring-type terminals 				
For electrical and mechanical connection between motor starter protector and contactor with spring-type terminals								
Single-unit packaging								
AC/DC	S00	S00	▶	3RA2911-2AA00		1	1 unit	41B
AC ²⁾	S0	S0	▶	3RA2921-2AA00		1	1 unit	41B
DC	S0	S0	▶	3RA2921-2AA00		1	1 unit	41B
Multi-unit packaging								
AC/DC	S00	S00	▶	3RA2911-2A		1	10 units	41B
AC ²⁾	S0	S0	▶	3RA2921-2A		1	10 units	41B
DC	S0	S0	▶	3RA2921-2A		1	10 units	41B
Spacers²⁾								
For compensating the height on AC contactors								
Single-unit packaging	S0	S0	▶	3RA2911-1CA00		1	1 unit	41B
Multi-unit packaging	S0	S0	▶	3RA2911-1C		1	5 units	41B

¹⁾ The link modules for motor starter protector to contactor cannot be used for 3RV2.21-4PA1., 3RV2.21-4FA1., 3RV2.31-4K.1., 3RV2.31-4R.1., 3RV2.32-4K.1., 3RV2.32-4R.1., 3RV27 and 3RV28 motor starter protectors/circuit breakers.

²⁾ A spacer for height compensation on AC contactors size S0 is optionally available.

Note:

Link modules can be used in

- Sizes S00 and S0 up to max. 32 A
- Size S2 up to max. 65 A

Motor Starter Protectors/Circuit Breakers





SIRIUS 3RV2 Motor Starter Protectors/Circuit Breakers

Accessories

Mounting accessories

Size	SD	Article No.	Price per PU	PU (UNIT, SET, M)	PS*	PG
3RW30, 3RW40 soft starters; 3RF34 solid-state contactors	3RV2 motor starter protectors/ circuit breakers					

Link modules for motor starter protector to soft starter¹⁾ and motor starter protector to solid-state contactor¹⁾

 3RA2921-1BA00		Connection between motor starter protector and soft starter / solid-state contactor with screw terminals Single-unit packaging S00 S00/S0 2 S0 S00/S0 2 S2 ²⁾ S2 ▶ S3 ³⁾ S3 ³⁾ ▶		Screw terminals 			
 3RA2931-1AA00		Multi-unit packaging S00 S00/S0 2 S0 S00/S0 2 S2 ²⁾ S2 ▶ S3 ³⁾ S3 ³⁾ ▶		3RA2921-1B 3RA2921-1B 3RA2931-1A 3RA1941-1A		1 1 unit 41B 1 1 unit 41B 1 1 unit 41B 1 1 unit 41B 1 10 units 41B 1 10 units 41B 1 5 units 41B 1 5 units 41B	
 3RA2921-2GA00		Connection between motor starter protector and soft starter spring-type terminals Single-unit packaging S00 S00 ▶ S0 S0 ▶		Spring-type terminals 		3RA2911-2GA00 3RA2921-2GA00 1 1 unit 41B 1 1 unit 41B	

- ¹⁾ The link modules for motor starter protector to soft starter and motor starter protector to solid-state contactor cannot be used for 3RV2.21-4PA1., 3RV2.21-4FA1., 3RV2.31-4K.1., 3RV2.31-4R.1., 3RV2.32-4K.1., 3RV2.32-4R.1., 3RV27 and 3RV28 motor starter protectors/circuit breakers.
- ²⁾ To assemble the feeder between a motor starter protector and a soft starter in size S2, the 3RA2932-1AC00 standard mounting rail adapter must be used.
- ³⁾ It is only permissible to assemble the feeder between the motor starter protector and the soft starter in size S3 on a mounting plate.

Note:

Link modules can be used in



- Sizes S00 and S0 up to max. 32 A
- Size S2 up to max. 65 A

Motor Starter Protectors/Circuit Breakers

SIRIUS 3RV2 Motor Starter Protectors/Circuit Breakers

Accessories

Mounting accessories



Actuating voltage of contactor	Size	3RV2 motor starter protectors	SD	Article No.	Price per PU	PU (UNIT, SET, M)	PS*	PG
	3RT2 contactors		d					
Hybrid link modules for motor starter protector to contactor¹⁾								
Mechanical and electrical connection between motor starter protector with screw terminals and contactor with spring-type terminals								
Single-unit packaging								
	AC/DC	S00	S00	▶	3RA2911-2FA00	1	1 unit	41B
	AC ²⁾ /DC	S0	S0	▶	3RA2921-2FA00	1	1 unit	41B
3RA2911-2FA00	Multi-unit packaging							
	AC/DC	S00	S00	▶	3RA2911-2F	1	10 units	41B
	AC ²⁾ /DC	S0	S0	▶	3RA2921-2F	1	10 units	41B
3RA2921-2FA00	Spacers²⁾							
For compensating the height on AC contactors								
	Single-unit packaging	S0	S0	2	3RA2911-1CA00	1	1 unit	41B
	Multi-unit packaging	S0	S0	2	3RA2911-1C	1	5 units	41B
3RA2911-1CA00								

¹⁾ The hybrid link modules for motor starter protector to contactor cannot be used for 3RV2.21-4PA1., 3RV2.21-4FA1., 3RV27 and 3RV28 motor starter protectors/circuit breakers. They are suitable only for constructing direct-on-line starters.

²⁾ A spacer for height compensation on AC contactors size S0 is optionally available.

Note:

Hybrid link modules in sizes S00 and S0 can be used up to max. 32 A.

For motor starter protectors/circuit breakers	Version	SD	Article No.	Price per PU	PU (UNIT, SET, M)	PS*	PG	
Type		d						
Motor feeder connectors for motor starter protectors/circuit breakers with screw terminals								
	3RV2.2	Adapters for motor starter protectors/circuit breakers Ambient temperature $t_{u \max.} = 60 \text{ °C}$ Size S0, rated operational current I_e at AC-3/400 V: 25 A	5	Screw terminals 	1	1 unit	41B	
	3RT1926-4RD01			3RT1926-4RD01				
	3RV2.2	Motor feeder connectors for motor starter protectors/circuit breakers Size S0	5	3RT1900-4RE01	1	1 unit	41B	
	3RT1900-4RE01							

Motor Starter Protectors/Circuit Breakers

SIRIUS 3RV2 Motor Starter Protectors/Circuit Breakers

Accessories

Enclosures and front plates

Overview

Enclosures

For stand-alone installation of 3RV20 to 3RV24 motor starter protectors size S00 ($I_{n\ max} = 16\ A$), S0 ($I_{n\ max} = 32\ A$) and S2 ($I_{n\ max} = 65\ A$), cast aluminum enclosures for surface mounting and molded-plastic enclosures for flush mounting are available in various dimensions.

When installed in a molded-plastic enclosure the motor starter protectors have a rated operational voltage U_e of 500 V.

The enclosures for surface mounting have the degree of protection IP55; the enclosures for flush mounting also comply with the degree of protection IP55 at the front (the flush-mounted section complies with IP20).

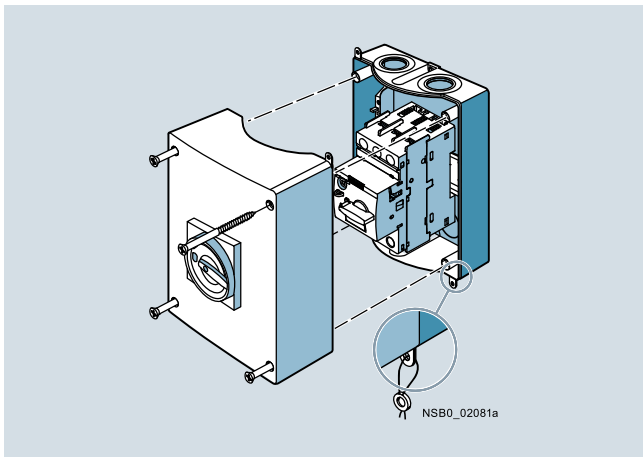

Enclosures for surface mounting

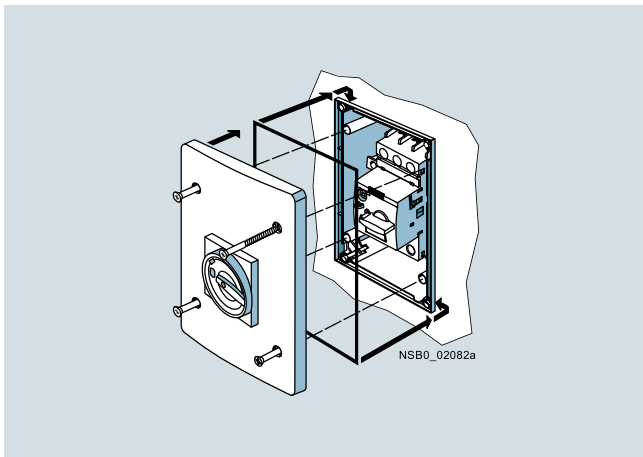

Enclosures (only for sizes S00 and S0)

All enclosures are equipped with N and PE terminals. There are two knock-out cable entries for cable glands at the top and two at the bottom; also on the rear corresponding cable entries are scored. There is a knockout on the top of the enclosure for indicator lights that are available as accessories.

The narrow enclosure can accommodate a motor starter protector without accessories, with transverse auxiliary switch and with lateral auxiliary switch. There is no provision for installing a motor starter protector with a signaling switch.

With size S00 to S2 circuit breakers the molded-plastic enclosures are equipped with a rotary operating mechanism.

The enclosures can be supplied with either a black rotary operating mechanism or with an EMERGENCY-STOP rotary operating mechanism with a red/yellow knob.

In the OFF setting, all rotary operating mechanisms can be locked with up to three padlocks.

Front plates

Motor starter protectors are frequently required to be actuated in any enclosure. Front plates equipped with a rotary operating mechanism for 3RV20 to 3RV24 motor starter protectors sizes S00 to S3 are available for this purpose.

A holder for the motor starter protectors size S00 and S0, into which the motor starter protectors can be snapped, is available for the front plates.

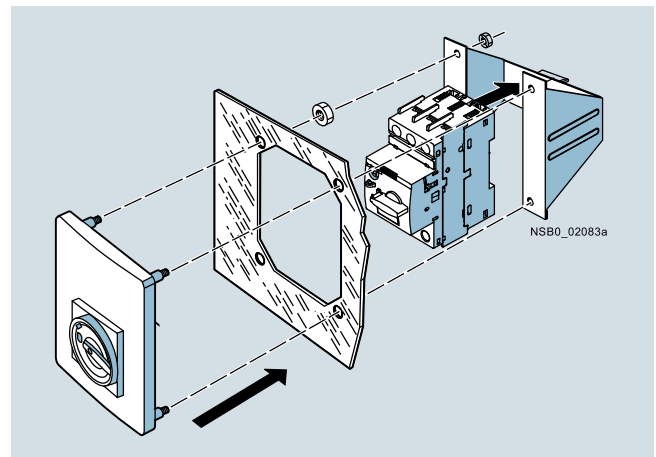

Front plate (including holder) for sizes S00 and S0





Motor Starter Protectors/Circuit Breakers

SIRIUS 3RV2 Motor Starter Protectors/Circuit Breakers

Accessories

Enclosures and front plates

Selection and ordering data

Version	Degree of protection	Integrated terminals	Width mm	For 3RV20 to 3RV24 motor starter protectors Size	SD d	Article No.	Price per PU	PU (UNIT, SET, M)	PS*	PG	
Molded-plastic enclosures for surface mounting¹⁾											
 3RV1933-1DA00	With rotary operating mechanism, lockable in 0 position	IP55	N and PE/ground	54 (for motor starter protector + lateral auxiliary switch)	S00, S0 ▶	3RV1923-1CA00		1	1 unit	41E	
				72 (for motor starter protector + lateral auxiliary switch ²⁾ + auxiliary release)	S00, S0 ▶	3RV1923-1DA00		1	1 unit	41E	
				82 (for motor starter protector + lateral auxiliary switch ²⁾ + auxiliary release)	S2	2	3RV1933-1DA00		1	1 unit	41E
 3RV1923-1FA00, 3RV1933-1GA00	With EMERGENCY-STOP rotary operating mechanism, lockable in 0 position	IP55	N and PE/ground	54 (for motor starter protector + lateral auxiliary switch)	S00, S0 ▶	3RV1923-1FA00		1	1 unit	41E	
				72 (for motor starter protector + lateral auxiliary switch ²⁾ + auxiliary release)	S00, S0 ▶	3RV1923-1GA00		1	1 unit	41E	
				82 (for motor starter protector + lateral auxiliary switch ²⁾ + auxiliary release)	S2	2	3RV1933-1GA00		1	1 unit	41E
Cast aluminum enclosures for surface mounting¹⁾											
 3RV1923-1DA01	With rotary operating mechanism, lockable in 0 position	IP65	PE ³⁾	72 (for motor starter protector + lateral auxiliary switch ²⁾ + auxiliary release)	S00, S0 ▶	3RV1923-1DA01		1	1 unit	41E	
				With EMERGENCY-STOP rotary operating mechanism, lockable in 0 position	IP65	PE ³⁾	72 (for motor starter protector + lateral auxiliary switch ²⁾ + auxiliary release)	S00, S0 ▶	3RV1923-1GA01		1
Molded-plastic enclosures for flush mounting⁴⁾											
 3RV1923-2DA00	With rotary operating mechanism, lockable in 0 position	IP55 (front side)	N and PE/ground	72 (for motor starter protector + lateral auxiliary switch ²⁾ + auxiliary release)	S00, S0	2	3RV1923-2DA00		1	1 unit	41E
				With EMERGENCY-STOP rotary operating mechanism, lockable in 0 position	IP55 (front side)	N and PE/ground	72 (for motor starter protector + lateral auxiliary switch ²⁾ + auxiliary release)	S00, S0	2	3RV1923-2GA00	

¹⁾ The rear cable glands cannot be used on 3RV2.11-...2. and 3RV2.21-...2. devices with spring-type terminals.

²⁾ Only valid for lateral auxiliary switches with two auxiliary contacts.

³⁾ If required, an additional N terminal can be mounted (e.g. 8WA1011-1BG11).

⁴⁾ Not suitable for 3RV2.11-...2. and 3RV2.21-...2. devices with spring-type terminals.

Motor Starter Protectors/Circuit Breakers

SIRIUS 3RV2 Motor Starter Protectors/Circuit Breakers

Accessories

Enclosures and front plates

Version	Degree of protection	For 3RV20 to 3RV24 motor starter protectors	SD	Article No.	Price per PU	PU (UNIT, SET, M)	PS*	PG
---------	----------------------	---	----	-------------	--------------	-------------------	-----	----

Front plates



3RV1923-4B + 3RV1923-4G

Molded-plastic front plates with rotary operating mechanism, lockable in 0 position For actuation of 3RV2 motor starter protectors in any enclosure	IP55 (front side)	S00 to S3	▶	3RV1923-4B		1	1 unit	41E
Molded-plastic front plates with EMERGENCY-STOP rotary operating mechanism, red/yellow, lockable in 0 position EMERGENCY-STOP actuation of 3RV2 motor starter protectors in any enclosure	IP55 (front side)	S00 to S3	2	3RV1923-4E		1	1 unit	41E
Holders for front plates Holder is mounted on front plate, motor starter protector with and without accessories is snapped in.	--	S00, S0	▶	3RV1923-4G		1	1 unit	41E

Version	Rated control supply voltage U_s	For 3RV20 to 3RV24 motor starter protectors	SD	Article No.	Price per PU	PU (UNIT, SET, M)	PS*	PG
---------	------------------------------------	---	----	-------------	--------------	-------------------	-----	----

Indicator lights



3RV1903-5B

Indicator lights For all enclosures and front plates	110 ... 120	S00 to S3	5	3RV1903-5B		1	1 unit	41E
	220 ... 240		5	3RV1903-5C		1	1 unit	41E
• With LED lamp for versions 110 ... 120 V, with glow lamp for versions 220 ... 500 V	380 ... 415		5	3RV1903-5E		1	1 unit	41E
	480 ... 500		5	3RV1903-5G		1	1 unit	41E
• With colored lenses red, green, yellow-orange and clear								

Motor Starter Protectors/Circuit Breakers

SIRIUS 3RV2 Motor Starter Protectors/Circuit Breakers

3RV29 infeed system

Overview

The 3RV29 infeed system is a convenient means of energy supply and distribution for a group of several motor starter protectors or complete load feeders with screw or spring-type terminals in sizes S00 and S0. Motor starter protectors or load feeders with a rated current of maximum 32 A each can be used. 3RV21, 3RV27 and 3RV28 motor starter protectors/circuit breakers cannot be deployed in this system.

The system is based on a basic module complete with a lateral incoming unit (three-phase busbar with infeed). This infeed with spring-type terminals is mounted on the right or left, depending on the version, and can be supplied with a maximum conductor cross-section of 25 mm² (with end sleeve). A basic module has two sockets onto each of which a motor starter protector can be snapped.

Expansion modules (three-phase busbars for system expansion) are available for extending the system. The individual modules are connected through an expansion plug.

The electrical connection between the three-phase busbars and the motor starter protectors is implemented through plug-in connectors. The complete system can be mounted on a TH 35

standard mounting rail to IEC 60715, and can be expanded as required up to a maximum current carrying capacity of 63 A.

The system is mounted extremely quickly and easily thanks to the simple plug-in technique. Thanks to the lateral infeed, the system also saves space in the control cabinet. The additional height required for the infeed unit is only 30 mm. The alternative infeed possibilities on each side offer a high degree of flexibility for configuring the control cabinet: Infeed on left-hand or right-hand side as well as infeed on one side and outfeed on the other side to supply further loads are all possible. A terminal block with spring-type connections in combination with a standard mounting rail enables the integration of not only SIRIUS motor starter protectors but also single-phase, 2-phase and 3-phase components such as 5SY miniature circuit breakers or SIRIUS relay components.

The 3RV29 infeed system is approved in accordance with IEC to 500 V. It is also UL-approved and authorized for "Self-Protected Combination Motor Controller" (Type E starter) as well as for Type F starter (Type E starter + contactor).

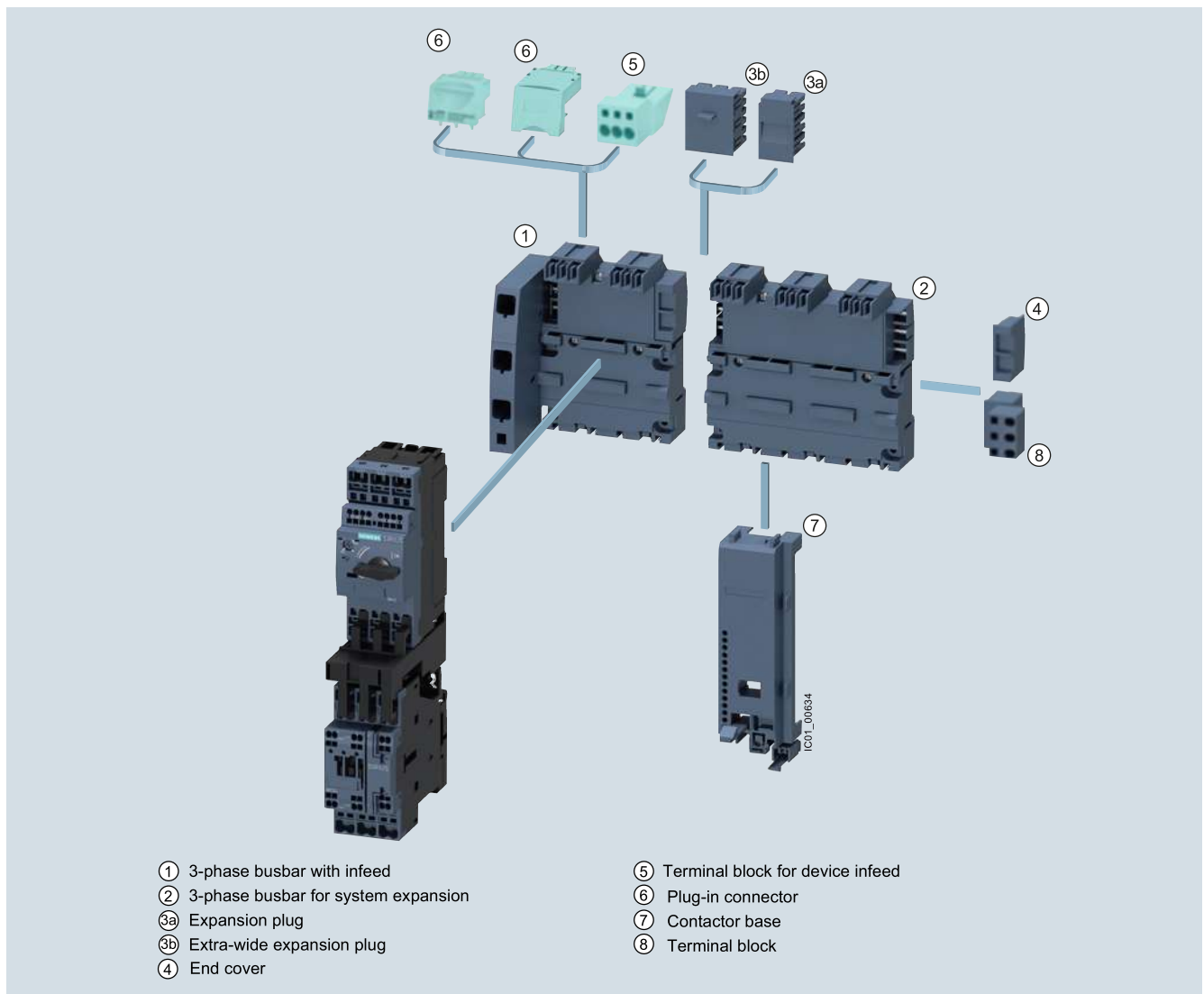

SIRIUS 3RV29 infeed systems

Motor Starter Protectors/Circuit Breakers

SIRIUS 3RV2 Motor Starter Protectors/Circuit Breakers

3RV29 infeed system

① Three-phase busbars with infeed

A three-phase busbar with infeed unit is required for connecting the incoming supply. These modules comprise one infeed module and two sockets which each accept one motor starter protector. A choice of two versions with infeed on the left or right is available. The infeed is connected to spring-type terminals. They permit an infeed with conductor cross-sections of up to 25 mm² with end sleeve. An end cover is supplied with each module.

② Three-phase busbars for system expansion

The three-phase busbars for system expansion support expansion of the system. There is a choice of modules with two or three sockets. The system can be expanded as required up to a maximum current carrying capacity of 63 A. An expansion plug is supplied with each module.

③a Expansion plug

The expansion plug is used for electrical connection of adjacent three-phase busbars. The current carrying capacity of this plug equals 63 A. One expansion plug is supplied with each three-phase busbar for system expansion. Additional expansion plugs are therefore only required as spare parts.

③b Extra-wide expansion plug

The wide expansion plug makes the electrical connection between two three-phase busbars, thus performing the same function as the 3RV2917-5BA00 expansion plug; the electrical characteristics (e.g. a current carrying capacity of 63 A) are identical.

The 3RV2917-5E expansion plug is 10 mm wider than the 3RV2917-5BA00 expansion plug, hence in the plugged state there is a distance of 10 mm between the connected three-phase busbars. This distance can be used to lay the auxiliary current and control current wiring ("wiring duct"). The motor starter protector and contactor can be wired from underneath, which means that the complete cable duct above the system can be omitted.

④ End cover

The end cover is used to cover the three-phase busbar at the open end of the system. This cover is therefore only required once for each system. An end cover is supplied with each three-phase busbar system with infeed. Further end covers are therefore only required as spare parts.

⑤ Terminal block for device infeed

A new addition to the system is a connector for outfeeding to a device slot within a module. This offers the option not only of connecting three-phase loads to the system, but also of integrating single-phase loads into the infeed system.

⑥ Plug-in connector

The plug-in connector is used for the electrical connection between the three-phase busbar and the 3RV2 motor starter protector. These plug-in connectors are available for screw or spring-type terminals.

⑦ Contactor base

Load feeders can be assembled in the system using the S00 and S0 contactor base. The contactor bases are suitable for contactors sizes S00 and S0 with spring-type and screw terminals and are simply snapped onto the three-phase busbars. Direct-on-line starters and reversing starters are possible. One contactor base is required for direct-on-line starters and two are required for reversing starters.

To assemble load feeders for reversing starters, the contactor bases can be arranged alongside each other (90 mm overall width). In this case the mechanical interlocking of the contactors is possible. The S0 contactor bases are also suitable for soft starters size S00 and S0 with screw terminal.

The infeed system is designed for mounting onto a TH 35 standard mounting rail with 7.5 mm overall depth. This standard mounting rail gives the contactor base a stable mounting surface to sit on. If standard mounting rails with a depth of 15 mm are used, the spacer connected to the bottom of the contactor base must be knocked out and plugged into the standard mounting rail mating piece, which is also located on the underside. Then the contactor base also has a stable mounting surface. When standard mounting rails with a depth of 7.5 mm are used, the spacer has no function and can be removed.

The link modules are used for direct start load feeders, in which case the use of a contactor base is not absolutely necessary. Motor starter protector and contactor assemblies can then be directly snapped onto the sockets of the three-phase busbars. For feeders of sizes S00 and S0, the corresponding 3RA1921-1....., 3RA2911-2....., 3RA2921-1..... or 3RA2921-2..... link modules should generally be used.

⑧ Terminal block

The 3RV2917-5D terminal block enables the integration of not only SIRIUS motor starter protectors but also single-phase, 2-phase and 3-phase components. The three phases can be fed out of the system using the terminal block; which means that single-phase loads can also be integrated in the system. The terminal block is plugged into the slot of the expansion plug and thus enables outfeeding from the middle or end of the infeed system. The terminal block can be rotated through 180° and be locked to the support modules of the infeed system. In addition, the 45 mm wide TH 35 3RV1917-7B standard mounting rail option for screwing onto the support plate facilitates plugging the single-phase, two-phase and three-phase components onto the infeed system.

Motor Starter Protectors/Circuit Breakers

SIRIUS 3RV2 Motor Starter Protectors/Circuit Breakers

3RV29 infeed system

Technical specifications

More information

Manual "SIRIUS – SIRIUS 3RV2 Motor Starter Protectors", see
<https://support.industry.siemens.com/cs/ww/en/view/60279172>

General data

Type	3RV29.7				
Size	S00, S0				
Standards					
• IEC 60947-2	✓				
• IEC 60947-4-1	✓				
• UL 508/UL 60947-4-1	✓				
Rated current I_n	A	63			
Permissible rated current at inside temperature of control cabinet					
Motor starter protectors	Size	Rated current	Inside temperature of control cabinet		
• 3RV2.11	S00	... 14 A	60 °C	%	100
		> 14 ... 16 A	40 °C	%	100
			60 °C	%	87
• 3RV2.21	S0	... 16 A	60 °C	%	100
		> 16 ... 25 A	40 °C	%	100
			60 °C	%	87
		> 25 ... 32 A	40 °C	%	87
Permissible ambient temperature					
• Storage/transport		°C	-50 ... +80		
• Operation		°C	-20 ... +60		
Rated operational voltage U_e					
• Acc. to IEC	10 % overvoltage	V AC	500		
	5 % overvoltage	V AC	525		
• Acc. to UL/CSA		V AC	600		
Rated frequency		Hz	50/60		
Rated impulse withstand voltage U_{imp}		kV	6		
Short-circuit strength	Corresponds to the mounted motor starter protector or load feeder				
Degree of protection acc. to IEC 60529	IP20 (In the terminal compartment of the infeed without connected IP00 conductor)				
Touch protection acc. to IEC 60529	Finger-safe				

✓ Yes

Conductor cross-sections

Type		Three-phase busbar with infeed 3RV2917-1A, 3RV2917-1E	Terminal block 3RV2917-5D	Terminal block for device infeed 3RV2917-5FA00
Conductor cross-sections (min./max.)				
• Solid or stranded	mm ²	4 ... 25	1.5 ... 6	1 ... 10
• Finely stranded with end sleeve	mm ²	4 ... 25	1.5 ... 4	1 ... 6
• Finely stranded without end sleeve	mm ²	6 ... 25	1.5 ... 6	--
• AWG cables	AWG	10 ... 3	15 ... 10	18 ... 8

-- No

Motor Starter Protectors/Circuit Breakers

SIRIUS 3RV2 Motor Starter Protectors/Circuit Breakers

3RV29 infeed system

Selection and ordering data

Type	Version	For 3RV20, 3RV23, 3RV24 motor starter protectors	SD	Article No.	Price per PU	PU (UNIT, SET, M)	PS*	PG
		Size	d					

Three-phase busbars with infeed



3RV2917-1A

Three-phase busbars with infeed incl. 3RV2917-6A end cover

For 2 motor starter protectors with screw or spring-type terminals

- With infeed on the left
- With infeed on the right

S00, S0	2
S00, S0	2

3RV2917-1A	1	1 unit	41E
3RV2917-1E	1	1 unit	41E

Three-phase busbars for system expansion



3RV2917-4A

Three-phase busbars incl. 3RV2917-5BA00 expansion plug

For motor starter protectors with screw or spring-type terminals

- For 2 motor starter protectors
- For 3 motor starter protectors

S00, S0	2
S00, S0	2

3RV2917-4A	1	1 unit	41E
3RV2917-4B	1	1 unit	41E

Plug-in connectors



3RV2917-5AA00

Plug-in connectors to make contact with motor starter protectors

- For spring-type terminals
 - Single-unit packaging S00¹⁾ S0²⁾
 - Multi-unit packaging S00¹⁾ S0²⁾

2	2
2	2

Spring-type terminals		
3RV2917-5AA00	1	1 unit
3RV2927-5AA00	1	1 unit
3RV2917-5A	1	10 units
3RV2927-5A	1	10 units



3RV2917-5CA00

- For screw terminals

S00 ¹⁾ S0 ²⁾	2
S00 ¹⁾ S0 ²⁾	2

Screw terminals		
3RV2917-5CA00	1	1 unit
3RV1927-5AA00	1	1 unit
3RV2917-5C	1	10 units
3RV1927-5A	1	10 units

¹⁾ I > 14 A, please note derating.

²⁾ I > 16 A, please note derating.

Type	Version	For contactors	SD	Article No.	Price per PU	PU (UNIT, SET, M)	PS*	PG
		Size	d					

Contactors bases



3RV2927-7AA00

Contactors bases for mounting direct-on-line or reversing starters

Single-unit packaging	S00	2
	S00, S0	2

3RV2917-7AA00	1	1 unit	41E
3RV2927-7AA00	1	1 unit	41E

Motor Starter Protectors/Circuit Breakers

SIRIUS 3RV2 Motor Starter Protectors/Circuit Breakers

3RV29 infeed system

Type	Version	SD	Article No.	Price per PU	PU (UNIT, SET, M)	PS*	PG
Terminal blocks							
	Terminal blocks for integration of single-phase, two-phase and three-phase components	Single-unit packaging	2	3RV2917-5D	1	1 unit	41E
3RV2917-5D							
TH 35 standard mounting rails, width 45 mm							
	TH 35 standard mounting rails acc. to IEC 60715, width 45 mm For mounting onto three-phase busbars	Single-unit packaging	2	3RV1917-7B	1	1 unit	41E
3RV1917-7B							
Extra-wide expansion plugs							
	Extra-wide expansion plugs As accessory	Single-unit packaging	2	3RV2917-5E	1	1 unit	41E
3RV2917-5E							
Expansion plugs							
	Expansion plugs¹⁾ As spare part	Single-unit packaging	2	3RV2917-5BA00	1	1 unit	41E
3RV2917-5BA00							
End covers							
	End covers²⁾ As spare part	Multi-unit packaging	2	3RV2917-6A	100	10 units	41E
3RV2917-6A							
Terminal blocks for device infeed							
	Terminal blocks for device infeed	Single-unit packaging	2	3RV2917-5FA00	1	1 unit	41E
3RV2917-5FA00							

¹⁾ The expansion plug is included in the scope of supply of the 3RV2917-4. three-phase busbars for system expansion.

²⁾ The end cover is included in the scope of supply of the 3RV2917-1. three-phase busbars with infeed system.

Motor Starter Protectors/Circuit Breakers

SIRIUS 3RV1 Motor Starter Protectors/Circuit Breakers

For fuse monitoring

Technical specifications

See pages 7/10, 7/12, 7/14, 7/18, 7/19 and 7/22

Selection and ordering data

Without auxiliary switches

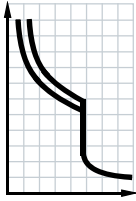

Rated current	Thermal overload releases	Instantaneous overcurrent release	Short-circuit breaking capacity at 400 V AC	SD	Screw terminals	PU (UNIT, SET, M)	PS*	PG
I_n		$I >$	I_{cu}	d	Article No.	Price per PU		
A	A	A	kA					

Size S00



3RV1611-0BD10

0.2	0.2	1.2	100	▶	3RV1611-0BD10		1	1 unit	41E
-----	-----	-----	-----	---	----------------------	--	---	--------	-----

Note:

The auxiliary switch required for signaling must be ordered separately.

Accessories

Version	Contacts	SD	Screw terminals	PU (UNIT, SET, M)	PS*	PG
		d	Article No.	Price per PU		

Mountable auxiliary switches (essential accessories)



3RV2901-1E

Transverse auxiliary switches With screw terminals, mountable on front	1 NO + 1 NC	▶	3RV2901-1E		1	1 unit	41E
--	-------------	---	-------------------	--	---	--------	-----



3RV2901-1A

Lateral auxiliary switches With screw terminals, mountable on the left	1 NO + 1 NC	▶	3RV2901-1A		1	1 unit	41E
--	-------------	---	-------------------	--	---	--------	-----

Motor Starter Protectors/Circuit Breakers SIRIUS 3RV1 Motor Starter Protectors/Circuit Breakers

For distance protection

Technical specifications

See page 7/23

Selection and ordering data

Voltage transformer circuit breakers with transverse auxiliary switches (1 CO)

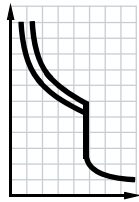

Rated current	Thermal overload releases	Instantaneous overcurrent release	Auxiliary switch integrated in the motor starter protector, transverse	Short-circuit breaking capacity at 400 V AC	SD	Screw terminals	PU (UNIT, SET, M)	PS*	PG
I_n		$I >$		I_{cu}		Article No.	Price per PU		
A	A	A		kA	d				

Size S00



3RV1611-1.G14

1.4	1.4	6	1 CO	50	5	3RV1611-1AG14	1	1 unit	41E
2.5	2.5	10.5	1 CO	50	▶	3RV1611-1CG14	1	1 unit	41E
3	3	20	1 CO	50	▶	3RV1611-1DG14	1	1 unit	41E

Accessories

Version	Contacts	SD	Screw terminals	PU (UNIT, SET, M)	PS*	PG
			Article No.	Price per PU		
		d				

Mountable auxiliary switches for other signaling purposes



3RV2901-1A

Lateral auxiliary switches With screw terminals, mountable on the left	1 NO + 1 NC	▶	3RV2901-1A	1	1 unit	41E
--	-------------	---	-------------------	---	--------	-----

Motor Starter Protectors/Circuit Breakers

SIRIUS 3RV1 Molded Case Motor Starter Protectors up to 800 A

General data

Overview

More information

Home page, see www.siemens.com/sirius-circuit-breaker



SIRIUS 3RV1063-7AL10 molded case motor starter protector

The 3RV10 and 3RV13 molded case motor starter protectors for up to 800 A are compact, current-limiting motor starter protectors which can be used above all in motor feeders for special voltages of 440 V, 480 V, 550 V and 690 V. They are used for switching and protecting three-phase motors and other loads with rated currents up to 800 A.

Note:

For motor feeders above 100 A and at 400 V and 500 V, the 3VL molded case motor starter protectors must be used, see [Catalog LV 10](#).

Type of construction

The molded case motor starter protectors are available in 4 widths:

- 3RV1353 – width 90 mm, max. rated current 32 A at 550 V AC suitable for three-phase motors up to 22 kW
- 3RV1.6. – width 105 mm, max. rated current 250 A at 690 V AC suitable for three-phase motors up to 160 kW
- 3RV1.7. – width 140 mm, max. rated current 630 A at 690 V AC suitable for three-phase motors up to 315 kW
- 3RV1.83 – width 210 mm, max. rated current 800 A at 690 V AC suitable for three-phase motors up to 500 kW

The 3RV1 molded case motor starter protectors for up to 800 A can be mounted in horizontal, vertical or lying arrangement directly on a mounting plate or mounting rail. Their rated data are adversely affected as the result.

The phase barriers for better insulation between the phases are included in the scope of supply, and it is essential to use them.

The motor starter protectors can be supplied through top and bottom terminals without impairing their function, enabling them to be installed in any type of switchgear without any further steps.

Connection methods

The 3RV1 molded case motor starter protectors up to 800 A are suitable solely for screw connection.



Screw terminals

The terminals are indicated in the corresponding tables by the symbols shown on orange backgrounds.

Article No. scheme

Product versions	Article number
Molded case motor starter protectors	3RV1 □ □ □ - □ □ □ □ - □ □ □ □
Type of motor starter protector/ e. g. 0 = for motor protection circuit breaker	□
Rated current e. g. 6 = 100 A	□
Breaking capacity e. g. 3 = standard switching capacity	□
Setting range for overload release e. g. 7A = 40 ... 100 A	□ □
Trip class (CLASS) e.g. L = CLASS 10A, 10, 20, 30	□
Connection methods e. g. 1 = screw terminals	□
With or without auxiliary switch e. g. 0 = without	□
Special versions	□ □ □ □
Example	3RV1 0 6 3 - 7 A L 1 0

Note:

The Article No. scheme shows an overview of product versions for better understanding of the logic behind the article numbers.

For your orders please use the article numbers quoted in the selection and ordering data.

Motor Starter Protectors/Circuit Breakers

SIRIUS 3RV1 Molded Case Motor Starter Protectors up to 800 A

General data

Benefits

- High short-circuit breaking capacity in the feeder
- Optimum usability in motor feeders for the special voltages 440 V, 480 V, 550 V and 690 V
- Compact design
- The releases are available both in purely magnetic (up to 32 A) and in solid-state versions (100 A to 800 A).
- Available for motor or starter protection (short-circuit protection alone)

Application

Operating conditions

The 3RV1 molded case motor starter protectors for up to 800 A can be operated at ambient temperatures between -25 °C and +70 °C. They can be used according to IEC 60721-2-1 in the most difficult environmental conditions with a hot and damp climate.

Since operational currents, starting currents and current peaks are different even for motors with identical power ratings due to the inrush current, the motor ratings in the selection tables are only guide values. The specific rated and start up data of the motor to be protected is always paramount to the choice of the most suitable molded case motor starter protectors.

The 3RV1 molded case motor starter protectors up to 800 A have not been tested for use with frequency converters. The possibility of premature tripping in such applications cannot therefore be ruled out.

Possible uses

The 3RV1 molded case motor starter protectors for up to 800 A are suitable as switching and protection devices for motors. The following versions are available:

- For motor protection; the overload and short-circuit releases are designed for optimized protection and direct-on-line starting of three-phase AC squirrel-cage motors. The motor starter protectors have an electronic release which not only provides short-circuit and overload protection but is also sensitive to phase failure and phase asymmetry and offers protection in the event of rotor blockage.
- For starter combinations; these molded case motor starter protectors are used for short-circuit protection in combinations of circuit breaker, motor contactor and overload relay. They are equipped with a purely magnetic release (up to 32 A) or a solid-state release (100 A to 800 A).

Standards and specifications

The overcurrent releases for motor protection comply with IEC 60947-4-1. Isolating features are also compliant with IEC 60947-2.

The 3RV1 molded case motor starter protectors comply in addition with IEC 60068-2-6 (shock and vibration strength) and are certified for the specifications of the major marine classification societies:

- RINA
- Det Norske Veritas
- Bureau Veritas
- Lloyds Register of Shipping
- Germanischer Lloyd
- American Bureau of Shipping

Use of SIRIUS protection devices in conjunction with IE3/IE4 motors

Note:

For the use of 3RV1 motor starter protectors/circuit breakers in conjunction with highly energy-efficient IE3/IE4 motors, please observe the information on dimensioning and configuring, [see Application Manual](#).

For more information, [see Preface on page 7](#).

Motor Starter Protectors/Circuit Breakers

SIRIUS 3RV1 Molded Case Motor Starter Protectors up to 800 A

General data

Technical specifications

More information

Configuration Manual "SIRIUS Configuration – Selection Data for Fuseless Load Feeders", see <https://support.industry.siemens.com/cs/ww/en/view/40625241> Reference Manual "Protection Equipment – Circuit Breakers - Molded Case Circuit Breakers", see <https://support.industry.siemens.com/cs/ww/en/view/35681461>

General data

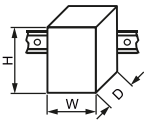
Type		3RV1063	3RV1073	3RV1083	3RV1353	3RV1363	3RV1364	3RV1373	3RV1374	3RV1383
Dimensions										
• W	mm	105	140	210	90	105	105	140	140	210
• H	mm	205	205	268	130	205	205	205	205	268
• D	mm	139	139	159	102	139	139	139	139	159
Standard		IEC 60947-2, EN 60947-2								
Motor protection		✓			--					
Starter combinations		--			✓					
Rated current I_n	A	160	400	630	160	250		400, 630		630, 800
Number of poles		3								
Rated operational voltage U_e 50 ... 60 Hz AC	V	690								
Rated impulse withstand voltage U_{imp}	V	8								
Rated insulation voltage U_i	V	1 000			800	1 000				
Test voltage at industrial frequency for 1 min	V	3 500			3 000	3 500				
Rated ultimate short-circuit breaking capacity I_{cu}										
• At 220/230 V AC, 50 ... 60 Hz	kA	200			120	200				
• At 380/415 V AC, 50 ... 60 Hz	kA	120		100	85	120	200	120	200	100
• At 440 V AC, 50 ... 60 Hz	kA	100		80	75	100	180	100	180	80
• At 500 V AC, 50 ... 60 Hz	kA	85		65	50	85	150	85	150	65
• At 550 V AC, 50 ... 60 Hz	kA	--			35	--				
• At 690 V AC, 50 ... 60 Hz	kA	70		30	10	70	80	70	80	30
Rated service short-circuit breaking capacity I_{cs} (% of I_{cu})										
• At 220/230 V AC, 50 ... 60 Hz	%	100		75	100					75
• At 380/415 V AC, 50 ... 60 Hz	%	100		75		100				75
• At 440 V AC, 50 ... 60 Hz	%	100		75		100				75
• At 500 V AC, 50 ... 60 Hz	%	100		75		100			100 ^{1)/75²⁾}	100
• At 690 V AC, 50 ... 60 Hz	%	100		75		100			100 ^{1)/50²⁾}	100
Rated short-circuit making capacity (415 V)	kA	264		220	187	264	440	264	440	220
Break time (415 V at I_{cu})	ms	5	6	7	3	5		6		7
Category (IEC 60947-2)	A		B (400 A), A (630 A)		A			B (400 A), A (630 A)		B
Isolating features		✓								
Trip class CLASS		10A, 10, 20, 30			--					
Releases										
• Magnetic type		--			✓	--				
• Electronic (motor protection)		✓			-- ³⁾					
• Electronic (starter combinations)		--			✓					
Permissible ambient temperature										
• Operation	°C	-25 ... +70 ⁴⁾								
• Storage	°C	-40 ... +70								
Mechanical endurance										
• Operating cycles		20 000			25 000	20 000				
• Operating cycles per hour		240	120		240			120		
Electrical endurance										
• Operating cycles		8 000	7 000	5 000	8 000			7 000		5 000
• Operating cycles per hour (415 V AC)		120	60		120			60		

✓ Has this function

-- Does not have this function

1) Value applies for 3RV1373-7GN10 molded case motor starter protectors.

2) Value applies for 3RV1373-7JN10 molded case motor starter protectors.

3) For overload protection of the motors, appropriate overload relays must be used.

4) From 50 °C, derating applies in some cases.

Motor Starter Protectors/Circuit Breakers

SIRIUS 3RV1 Molded Case Motor Starter Protectors up to 800 A

General data

Main circuit terminals					
Type	3RV1353	3RV1.6.	3RV1.7.	3RV1083-7JL10, 3RV1383-7JN10	3RV1383-7KN10

Terminal dimensions

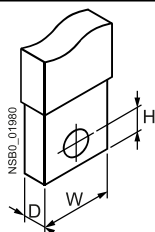

Front-accessible standard terminals					
Busbars/cable lug					
Number	Unit(s)	11		2	
Dimensions					
• W	mm	20	25	35	40
• D	mm	5	8	10	5
• H	mm	7.5	9.5	11	12
• Lock hasp diameter	mm	6.5	8.5	10.5	7
Front-extended terminals					
Busbars					
Number	Unit(s)	1		2	
Dimensions					
• W	mm	20		30	40
• D	mm	4	10	7	5
• Lock hasp diameter	mm	8.5	10	11	14
Cable lug					
Number	Unit(s)	1		2	
Dimensions					
• W	mm	20		30	40
• Lock hasp diameter	mm	8.5	10	11	14
Front-extended cable terminals for copper cable					
Busbars, flexible					
Number	Unit(s)	1			--
Dimensions W x D x N					
• W	mm	13	15.5	24	--
• D	mm	0.5	0.8	1	--
• N (= number of laminations)	mm	10			--
Cable lug, flexible					
Number	Unit(s)	1 or 2			--
Dimensions					
• For 1 unit	mm ²	1 ... 70	2.5 ... 120	16 ... 240	--
• For 2 units	mm ²	1 ... 50	2.5 ... 95	16 ... 150	--
Cable lug, rigid					
Number	Unit(s)	1		1 or 2	--
Dimensions					
• For 1 unit	mm ²	1 ... 95	2.5 ... 185	16 ... 300	--
• For 2 units (for outside mounting)	mm ²	--		120 ... 240	--
Rear terminals					
Busbars					
Number	Unit(s)	1		2	
Dimensions					
• W	mm	20		30	40
• D	mm	4	10	7	5
• Lock hasp diameter	mm	8.5		11	14

Motor Starter Protectors/Circuit Breakers

SIRIUS 3RV1 Molded Case Motor Starter Protectors up to 800 A

General data

Auxiliary switches					
Type		3RV1991-1.A0			
Rated operational current I_e					
• At 250 V AC/DC					
- At AC-14 (utilization category according to IEC 60947-5-1)					
Supply voltage 125 V	A	6			
Supply voltage 250 V	A	5			
- At DC-13 (utilization category according to IEC 60947-5-1)					
Supply voltage 125 V	A	0.3			
Supply voltage 250 V	A	0.15			
• At 24 V DC					
- Supply voltage 24 V	mA	≥ 0.75			
- Supply voltage 5 V	mA	≥ 1			
Auxiliary releases					
		Power consumption during pick-up			
Molded case motor starter protectors					
Version		3RV1353		3RV1.6., 3RV1.7., 3RV1.83	
		AC	DC	AC	DC
Undervoltage releases		3RV1952-1A.0		3RV1982-1A.0	
• 24 ... 30 V AC/DC		1.5 VA	1.5 W	6 VA	3 W
• 110 ... 127 V AC/110 ... 125 V DC		2 VA	2 CO	6 VA	3 W
• 220 ... 240 V AC/220 ... 250 V DC		2.5 VA	2.5 W	6 VA	3 W
Opening times	ms	15	15	≤ 25	≤ 15
Shunt releases		3RV1952-1E.0		3RV1982-1E.0	
• 24 ... 30 V AC/DC		50 VA	50 W	150 VA	150 W
• 110 ... 127 V AC/110 ... 125 V DC		50 VA	50 W	150 VA	150 W
• 220 ... 240 V AC/220 ... 250 V DC		50 VA	50 W	150 VA	150 W
Opening times	ms	15	15	15	15

Motor Starter Protectors/Circuit Breakers

SIRIUS 3RV1 Molded Case Motor Starter Protectors up to 800 A

IE3/IE4 ready

For motor protection

Selection and ordering data

CLASS 10A, 10, 20, 30; without auxiliary switch

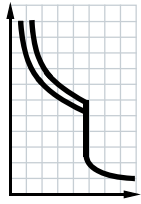

Rated current	Current setting of the inverse-time delayed overload releases "L" I_R	Operating current of the instantaneous short-circuit releases "I" I_i	Short-circuit breaking capacity at 400 V AC	SD	Screw terminals	PU (UNIT, SET, M)	PS*	PG
I_n			I_{cu}		Article No.	Price per PU		
A	A	A	kA	d				

With electronic releases



3RV10.3-7.L10

TU = trip unit (release)

Further accessories can be ordered separately (see "Accessories" page 7/69 onwards).

Standard switching capacity, adjustable short-circuit and overload release, TU 4

100	40 ... 100	600 ... 1 300	120	20	3RV1063-7AL10	1	1 unit	41E
160	64 ... 160	960 ... 2 080	120	20	3RV1063-7CL10	1	1 unit	41E
200	80 ... 200	1 200 ... 2 600	120	20	3RV1063-7DL10	1	1 unit	41E
400	160 ... 400	2 400 ... 5 200	120	20	3RV1073-7GL10	1	1 unit	41E
630	252 ... 630	3 780 ... 8 190	100	20	3RV1083-7JL10	1	1 unit	41E

Motor Starter Protectors/Circuit Breakers

SIRIUS 3RV1 Molded Case Motor Starter Protectors up to 800 A

For starter combinations **IE3/IE4 ready**

Selection and ordering data

Without auxiliary switches

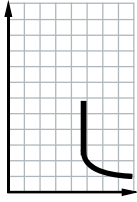

Rated current	Inverse-time delayed overload release "L" I_R	Operating current of the instantaneous short-circuit releases "I" I_f	Short-circuit breaking capacity at 400 V AC	SD	Screw terminals	PU (UNIT, SET, M)	PS*	PG
I_n			I_{cu}		Article No.	Price per PU		
A	A	A	kA	d				

With magnetic releases



3RV1353-6.P10

Standard switching capacity, non-adjustable short-circuit release, TU 1

1	Without	13	85	20	3RV1353-6AP10	1	1 unit	41E
1.6	Without	21	85	20	3RV1353-6BP10	1	1 unit	41E
2	Without	26	85	20	3RV1353-6CP10	1	1 unit	41E
3.2	Without	42	85	20	3RV1353-6DP10	1	1 unit	41E
4	Without	52	85	20	3RV1353-6EP10	1	1 unit	41E
5	Without	65	85	20	3RV1353-6FP10	1	1 unit	41E
6.5	Without	85	85	20	3RV1353-6GP10	1	1 unit	41E
8.5	Without	111	85	20	3RV1353-6HP10	1	1 unit	41E
12.5	Without	163	85	20	3RV1353-6JP10	1	1 unit	41E

Standard switching capacity, adjustable short-circuit release, TU 2

20	Without	120 ... 240	85	20	3RV1353-6LM10	1	1 unit	41E
32	Without	192 ... 384	85	20	3RV1353-6MM10	1	1 unit	41E

With electronic releases



3RV13...-7.N10

Standard switching capacity, adjustable short-circuit release, TU 3

100	Without	100 ... 1 000	120	20	3RV1363-7AN10	1	1 unit	41E
160	Without	160 ... 1 600	120	20	3RV1363-7CN10	1	1 unit	41E
250	Without	250 ... 2 500	120	20	3RV1363-7EN10	1	1 unit	41E
400	Without	400 ... 4 000	120	20	3RV1373-7GN10	1	1 unit	41E
630	Without	630 ... 6 300	120	20	3RV1373-7JN10	1	1 unit	41E
630	Without	630 ... 6 300	100	20	3RV1383-7JN10	1	1 unit	41E
800	Without	800 ... 8 000	100	20	3RV1383-7KN10	1	1 unit	41E

Increased switching capacity, adjustable short-circuit release, TU 3

100	Without	100 ... 1 000	200	20	3RV1364-7AN10	1	1 unit	41E
160	Without	160 ... 1 600	200	20	3RV1364-7CN10	1	1 unit	41E
250	Without	250 ... 2 500	200	20	3RV1364-7EN10	1	1 unit	41E
400	Without	400 ... 4 000	200	20	3RV1374-7GN10	1	1 unit	41E

TU = trip unit (release)

Further accessories can be ordered separately (see "Accessories" page 7/69 onwards).

Motor Starter Protectors/Circuit Breakers

SIRIUS 3RV1 Molded Case Motor Starter Protectors/Circuit Breakers

Accessories

Mountable accessories

Selection and ordering data

Type	Version	For molded case motor starter protectors	SD	Screw terminals 	PU (UNIT, SET, M)	PS*	PG
				Article No.	Price per PU		

Auxiliary switches



3RV1991-1AA0

Auxiliary switches For mounting on the front	1 signaling switch Off-On + 1 tripped signal (250 V AC/DC)	3RV1353, 3RV1.6, ... 3RV1.83	20	3RV1991-1AA0	1	1 unit	41E
	3 signaling switches Off-On + 1 tripped signal (250 V AC/DC)	3RV1.83	20	3RV1991-1BA0	1	1 unit	41E
	3 signaling switches Off-On + 1 tripped signal (24 V DC)		20	3RV1991-1CA0	1	1 unit	41E
	Connection cables for auxiliary switches	Length 2 m, 6-pole	3RV1353, 3RV1.6, ... 3RV1.83	20	3RV1991-1FA0	1	1 unit

Type	Rated control supply voltage U_s		For molded case motor starter protectors	SD	Screw terminals 	PU (UNIT, SET, M)	PS*	PG
		AC 50/60 Hz	DC					
		V	V	d	Article No.	Price per PU		

Auxiliary releases



3RV1952-1AA0

Undervoltage releases For mounting on the front	24 ... 30	24 ... 30	3RV1353	20	3RV1952-1AA0	1	1 unit	41E
	110 ... 127	110 ... 125		20	3RV1952-1AD0	1	1 unit	41E
	220 ... 240	220 ... 250		20	3RV1952-1AE0	1	1 unit	41E
	24 ... 30	24 ... 30	3RV1.6	20	3RV1982-1AA0	1	1 unit	41E
	110 ... 127	110 ... 125	...	20	3RV1982-1AD0	1	1 unit	41E
	220 ... 240	220 ... 250	3RV1.83	20	3RV1982-1AF0	1	1 unit	41E



3RV1952-1EA0

Shunt releases For mounting on the front	24 ... 30	24 ... 30	3RV1353	20	3RV1952-1EA0	1	1 unit	41E
	110 ... 127	110 ... 125		20	3RV1952-1ED0	1	1 unit	41E
	220 ... 240	220 ... 250		20	3RV1952-1EF0	1	1 unit	41E
	24 ... 30	24 ... 30	3RV1.6	20	3RV1982-1EA0	1	1 unit	41E
	110 ... 127	110 ... 125	...	20	3RV1982-1ED0	1	1 unit	41E
	220 ... 240	220 ... 250	3RV1.83	20	3RV1982-1EF0	1	1 unit	41E
Connection cables for undervoltage and shunt releases	Length 2 m, 6-pole		3RV1353, 3RV1.6, ... 3RV1.83	20	3RV1992-1FA0	1	1 unit	41E





Motor Starter Protectors/Circuit Breakers

SIRIUS 3RV1 Molded Case Motor Starter Protectors/Circuit Breakers

Accessories

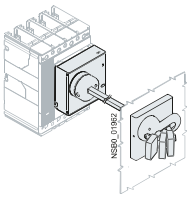
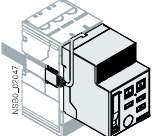
Rotary operating mechanisms, mounting accessories

Selection and ordering data

Version	For molded case motor starter protectors	SD	Screw terminals		PU (UNIT, SET, M)	PS*	PG
		d	Article No.		Price per PU		
Rotary operating mechanisms							
	Lever-type rotary operating mechanisms	with adjustable distance,	3RV1353	20	3RV1956-0BA0	1	1 unit 41E
		with lock/door interlocking (padlocks are not included in scope of supply)	3RV1.6., 3RV1.7.	20	3RV1976-0BA0	1	1 unit 41E
			3RV1.83	20	3RV1986-0BA0	1	1 unit 41E
3RV19.6-0BA0							
	Motorized operating mechanisms	With stored energy mechanism, 220 ... 250 V AC/DC	3RV1.6., 3RV1.7.	20	3RV1976-3AP3	1	1 unit 41E
			3RV1.83	20	3RV1986-3AP3	1	1 unit 41E
3RV19.6-3AP3							
Connections							
	Connections	Front-extended (1 set = 6 units)	3RV1353	20	3RV1955-1AA0	1	1 unit 41E
			3RV1.6.	20	3RV1965-1BA0	1	1 unit 41E
			3RV1.7.	20	3RV1975-1CA0	1	1 unit 41E
			3RV1.83-7J.10	20	3RV1985-1DA0	1	1 unit 41E
			3RV1.83-7KN10	20	3RV1985-1EA0	1	1 unit 41E
3RV1975-1CA0							
		Rear (1 set = 3 units)	3RV1353	20	3RV1955-3AA0	1	1 unit 41E
			3RV1.6.	20	3RV1965-3AA0	1	1 unit 41E
			3RV1.7.	20	3RV1975-3AA0	1	1 unit 41E
			3RV1.83	20	3RV1985-3AA0	1	1 unit 41E
3RV1955-3AA0							
	Cable terminals	Front-extended (1 set = 6 units)	3RV1353	20	3RV1955-2AA0	1	1 unit 41E
			3RV1.6.	20	3RV1965-2BA0	1	1 unit 41E
			3RV1.7.-7G.10	20	3RV1975-2CA0	1	1 unit 41E
			3RV1.73-7JN10	20	3RV1975-2DA0	1	1 unit 41E
3RV1975-2AA0							

Overview

More information

Home page, see <http://www.siemens.com/sirius-overloadrelays>

Industry Mall, see

- www.siemens.com/product?3RU2
- www.siemens.com/product?3RB3
- www.siemens.com/product?3RB2

Configuration Manuals, see

- "SIRIUS Configuration – Selection Data for Fuseless Load Feeders", <https://support.industry.siemens.com/cs/ww/en/view/40625241>
- "Configuring SIRIUS Innovations – Selection Data for Fuseless and Fused Load Feeders", <https://support.industry.siemens.com/cs/ww/en/view/39714188>



Features	3RU21	3RB30/3RB31	3RB20/3RB21	3RB22/3RB23	3RB24	Benefits
General data						
Sizes	S00 ... S3	S00 ... S3	S6 ... S12	S00 ... S12	S00 ... S12	<ul style="list-style-type: none"> • Are coordinated with the dimensions, connections and technical characteristics of the other devices in the SIRIUS modular system (contactors, etc., ...) • Permit the mounting of slim and compact load feeders in widths of 45 mm (S00, S0), 55 mm (S2), 70 mm (S3), 120 mm (S6) and 145 mm (S10/S12); this does not include the current measuring modules for the 3RB22 to 3RB24 evaluation modules sizes S00 to S3 • Simplify configuration
Seamless current range	0.11 ... 100 A	0.1 ... 115 A	50 ... 630 A	0.3 ... 630 A (up to 820 A) ¹⁾	0.3 ... 630 A (up to 820 A) ¹⁾	<ul style="list-style-type: none"> • Allows easy and consistent configuration with one series of overload relays (for small to large loads)
Protection functions						
Tripping due to overload	✓	✓	✓	✓	✓	<ul style="list-style-type: none"> • Provides optimum inverse-time delayed protection of loads against excessive temperature rises due to overload
Tripping due to phase asymmetry	✓	✓	✓	✓	✓	<ul style="list-style-type: none"> • Provides optimum inverse-time delayed protection of loads against excessive temperature rises due to phase asymmetry
Tripping due to phase failure	✓	✓	✓	✓	✓	<ul style="list-style-type: none"> • Minimizes heating of three-phase motors during phase failure
Protection of single-phase loads	✓	--	--	✓	✓	<ul style="list-style-type: none"> • Enables the protection of single-phase loads
Tripping due to overtemperature by integrated thermistor motor protection function	-- ²⁾	-- ²⁾	-- ²⁾	✓	✓	<ul style="list-style-type: none"> • Provides optimum temperature-dependent protection of loads against excessive temperature rises, e.g. for stator-critical motors or in the event of insufficient coolant flow, contamination of the motor surface or long starting or braking operations • Eliminates the need for additional special equipment • Saves space in the control cabinet • Reduces wiring outlay and costs
Tripping due to ground fault by internal ground-fault detection (can be activated)	--	✓ (only 3RB31)	✓ (only 3RB21)	✓	✓	<ul style="list-style-type: none"> • Provides optimum protection of loads against high-resistance short circuits or ground faults due to moisture, condensed water, damage to the insulation material, etc. • Eliminates the need for additional special equipment • Saves space in the control cabinet • Reduces wiring outlay and costs

- ✓ Available
- Not available

¹⁾ Motor currents up to 820 A can be recorded and evaluated by a current measuring module, e.g. 3RB2906-2BG1 (0.3 to 3 A), in combination with a 3UF1868-3GA00 (820 A/1 A) series transformer. For 3UF18 transformers see page 10/22.

²⁾ The SIRIUS 3RN thermistor motor protection devices can be used to provide additional temperature-dependent protection.

Overload Relays

General data



Features	3RU21	3RB30/3RB31	3RB20/3RB21	3RB22/3RB23	3RB24	Benefits
Features						
RESET function	✓	✓	✓	✓	✓	<ul style="list-style-type: none"> Allows manual or automatic resetting of the device
Remote RESET function	✓ (by means of separate module)	✓ (only with 3RB31 and external auxiliary voltage 24 V DC)	✓ (only with 3RB21 and external auxiliary voltage 24 V DC)	✓ (electrically via external button)	✓ (electrically with button or via IO-Link)	<ul style="list-style-type: none"> Allows the remote resetting of the device
TEST function for auxiliary contacts	✓	✓	✓	✓	✓	<ul style="list-style-type: none"> Allows easy checking of the function and wiring
TEST function for electronics	--	✓	✓	✓	✓	<ul style="list-style-type: none"> Allows checking of the electronics
Status display	✓	✓	✓	✓	✓	<ul style="list-style-type: none"> Displays the current operating state
Large current adjustment button	✓	✓	✓	✓	✓	<ul style="list-style-type: none"> Makes it easier to set the relay exactly to the correct current value
Integrated auxiliary contacts (1 NO + 1 NC)	✓	✓	✓	✓ (2 ×)	--	<ul style="list-style-type: none"> Allows the load to be switched off if necessary Can be used to output signals
Integrated auxiliary contacts (1 CO and 1 NO in series)	--	--	--	--	✓	<ul style="list-style-type: none"> Enables the controlling of contactors directly from the higher-level control system through IO-Link
IO-Link connection	--	--	--	--	✓	<ul style="list-style-type: none"> Reduction of wiring in the control cabinet Enables communication
Connection of optional hand-held device	--	--	--	--	✓	<ul style="list-style-type: none"> Enables local operation
Communication capability through IO-Link						
Full starter functionality through IO-Link	--	--	--	--	✓	<ul style="list-style-type: none"> Enables in combination with the SIRIUS 3RT contactors the assembly of communication-capable motor starters (direct-on-line, reversing and star-delta (wye-delta) starting)
Readout of diagnostics functions	--	--	--	--	✓	<ul style="list-style-type: none"> Enables the reading out of diagnostics information such as overload, open circuit, ground fault, etc.
Readout of current values	--	--	--	--	✓	<ul style="list-style-type: none"> Enables the reading out of current values and their direct processing in the higher-level control system
Readout of all set parameters	--	--	--	--	✓	<ul style="list-style-type: none"> Enables the reading out of all set parameters, e.g. for plant documentation

✓ Available

-- Not available



Features	3RU21	3RB30/3RB31	3RB20/3RB21	3RB22/3RB23	3RB24	Benefits
Design of load feeders						
Short-circuit strength up to 100 kA at 690 V (in conjunction with the corresponding fuses or the corresponding motor starter protector)	✓	✓	✓	✓	✓	<ul style="list-style-type: none"> Provides optimum protection of the loads and operating personnel in the event of short circuits due to insulation faults or faulty switching operations
Electrical and mechanical matching to 3RT contactors	✓	✓	✓	✓ ¹⁾	✓ ¹⁾	<ul style="list-style-type: none"> Simplifies configuration Reduces wiring outlay and costs Enables stand-alone installation as well as space-saving direct mounting
Straight-through transformers for main circuit²⁾ (in this case the cables are routed through the feed-through openings of the overload relay and connected directly to the box terminals of the contactor)	--	✓ (S2, S3)	✓ (S6)	✓ (S00 ... S6)	✓ (S00 ... S6)	<ul style="list-style-type: none"> Reduces the contact resistance (only one point of contact) Saves wiring costs (easy, no need for tools, and fast) Saves material costs Reduces installation costs
Spring-type connection system for main circuit²⁾	✓ (S00, S0)	✓ (S00, S0)	--	--	--	<ul style="list-style-type: none"> Enables fast connections Permits vibration-resistant connections Enables maintenance-free connections
Spring-type connection system for auxiliary circuits²⁾	✓	✓	✓	✓	✓	<ul style="list-style-type: none"> Enables fast connections Permits vibration-resistant connections Enables maintenance-free connections
Full starter functionality through IO-Link	--	--	--	--	✓	<ul style="list-style-type: none"> Enables in combination with the SIRIUS 3RT contactors the assembly of communication-capable motor starters (direct-on-line, reversing and star-delta (wye-delta) starting)
Starter function	--	--	--	--	✓	<ul style="list-style-type: none"> Integration of feeders via IO-Link in the control system up to 630 A or 820 A

✓ Available

-- Not available

¹⁾ Exception: up to size S3, only stand-alone installation is possible.²⁾ Alternatively available for screw terminals.

Overload Relays

General data



Features	3RU21	3RB30/3RB31	3RB20/3RB21	3RB22/3RB23	3RB24	Benefits
Other features						
Temperature compensation	✓	✓	✓	✓	✓	<ul style="list-style-type: none"> Allows the use of the relays at high temperatures without derating Prevents premature tripping Allows compact installation of the control cabinet without distance between the devices/load feeders Simplifies configuration Enables space to be saved in the control cabinet
Very high long-term stability	✓	✓	✓	✓	✓	<ul style="list-style-type: none"> Provides safe protection for the loads even after years of use in severe operating conditions
Wide setting ranges	--	✓ (1:4)	✓ (1:4)	✓ (1:10)	✓ (1:10)	<ul style="list-style-type: none"> Minimize the configuration outlay and costs Minimize storage overheads, storage costs, tied-up capital
Fixed trip class	CLASS 10, CLASS 10A	3RB30: CLASS 10E or CLASS 20E	3RB20: CLASS 10E or CLASS 20E	--	--	<ul style="list-style-type: none"> Optimum motor protection for standard starts
Trip classes adjustable on the device CLASS 5E, 10E, 20E, 30E	--	3RB31: ✓	3RB21: ✓	✓	✓	<ul style="list-style-type: none"> Enables solutions for very fast starting motors requiring special protection (e.g. Ex motors) Enables heavy starting solutions Reduces the number of variants Minimizes the configuring outlay and costs Minimizes storage overhead, storage costs, and tied-up capital
Low power loss	--	✓	✓	✓	✓	<ul style="list-style-type: none"> Reduces power consumption and energy costs (up to 98 % less power is used than for thermal overload relays) Minimizes temperature rises of the contactor and control cabinet – in some cases this may eliminate the need for control cabinet cooling. Direct mounting to contactor saves space, even for high motor currents (i.e. no heat decoupling is required)
Internal power supply	-- ¹⁾	✓	✓	--	--	<ul style="list-style-type: none"> Eliminates the need for configuration and connecting an additional control circuit
Supplied from an external source via IO-Link	--	--	--	--	✓	<ul style="list-style-type: none"> Eliminates the need for configuration and connecting an additional control circuit

✓ Available
-- Not available

¹⁾ SIRIUS 3RU11 and 3RU21 thermal overload relays use a bimetal contactor and therefore do not require a control supply voltage.



Features	3RU21	3RB30/3RB31	3RB20/3RB21	3RB22/3RB23	3RB24	Benefits
Other features (continued)						
Overload warning	--	--	--	✓	✓	<ul style="list-style-type: none"> Indicates imminent tripping of the relay directly on the device due to overload, phase asymmetry or phase failure through flickering of the LEDs or in the case of the 3RB24 as a signal through IO-Link Allows the imminent tripping of the relay to be signaled Allows measures to be taken in time in the event of inverse-time delayed overloading of the load for an extended period over the current limit Eliminates the need for an additional device Saves space in the control cabinet Reduces wiring outlay and costs
Analog output	--	--	--	✓	✓	<ul style="list-style-type: none"> Allows the output of an analog output signal for actuating moving-coil instruments, feeding programmable logic controllers or transfer to bus systems Eliminates the need for an additional measuring transducer and signal converter Saves space in the control cabinet Reduces wiring outlay and costs

✓ Available
 -- Not available



Overload Relays

General data

Overview of overload relays – matching contactors

Overload relays	Current measurement	Current range	Contactors (type, size, rating in kW)								
			3RT201.	3RT202.	3RT203.	3RT204.	3RT105.	3RT106.	3RT107.	3TF68/3TF69	
Type	A		S00 3/4/5.5/7.5	S0 5.5/7.5/11/15/18.5	S2 15/18.5/22/30/37	S3 37/45/55	S6 55/75/90	S10 110/132/160	S12 200/250	14 375/450	

SIRIUS 3RU21 thermal overload relays



3RU211	Integrated	0.11 ... 16	✓	--	--	--	--	--	--	--
3RU212	Integrated	1.8 ... 40	--	✓	--	--	--	--	--	--
3RU213	Integrated	11 ... 80	--	--	✓	--	--	--	--	--
3RU214	Integrated	28 ... 100	--	--	--	✓	--	--	--	--

3RU21

SIRIUS 3RB30 electronic overload relays¹⁾



3RB301	Integrated	0.1 ... 16	✓	--	--	--	--	--	--	--
3RB302	Integrated	0.1 ... 40	--	✓	--	--	--	--	--	--
3RB303	Integrated	12.5 ... 80	--	--	✓	--	--	--	--	--
3RB304	Integrated	32 ... 115	--	--	--	✓	--	--	--	--

3RB30

SIRIUS 3RB31 electronic overload relays¹⁾



3RB311	Integrated	0.1 ... 16	✓	--	--	--	--	--	--	--
3RB312	Integrated	0.1 ... 40	--	✓	--	--	--	--	--	--
3RB313	Integrated	12.5 ... 80	--	--	✓	--	--	--	--	--
3RB314	Integrated	32 ... 115	--	--	--	✓	--	--	--	--

3RB31

SIRIUS 3RB20 electronic overload relays¹⁾



3RB205	Integrated	50 ... 200	--	--	--	--	✓	--	--	--
3RB206	Integrated	55 ... 630	--	--	--	--	--	✓	✓	✓
3RB201 + 3UF18	Integrated	630 ... 820	--	--	--	--	--	--	--	✓

3RB20

SIRIUS 3RB21 electronic overload relays¹⁾



3RB215	Integrated	50 ... 200	--	--	--	--	✓	--	--	--
3RB216	Integrated	55 ... 630	--	--	--	--	--	✓	✓	✓
3RB211 + 3UF18	Integrated	630 ... 820	--	--	--	--	--	--	--	✓

3RB21

SIRIUS 3RB22 to 3RB24 electronic overload relays¹⁾



3RB2283/ 3RB2383/ 3RB2483+	3RB2906	0.3 ... 25	✓	✓	--	--	--	--	--	--
	3RB2906	10 ... 100	✓	✓	✓	✓	--	--	--	--
	3RB2956	20 ... 200	--	✓	✓	✓	✓	--	--	--
	3RB2966	63 ... 630	--	--	--	--	--	✓	✓	✓
	3RB2906 + 3UF18	630 ... 820	--	--	--	--	--	--	--	✓

3RB22, 3RB23



3RB24

✓ Can be used
-- Cannot be used

¹⁾ "Technical specifications" for the use of overload relays with trip class ≥ CLASS 20E can be found in "Short-circuit protection with fuses for motor feeders" in the Configuration Manuals:
- "Configuring SIRIUS Innovations – Selection Data for Fuseless and Fused Load Feeders",
- "SIRIUS Configuration – Selection Data for Fuseless Load Feeders".

Connection methods3RU2 thermal overload relays

- Sizes S00 and S0:
 - Main and auxiliary circuit: Either screw or spring-type terminals
- Sizes S2 and S3:
 - Main circuit: Screw terminals with box terminal
 - Auxiliary circuit: Either screw or spring-type terminals

3RB3 electronic overload relays

- Sizes S00 and S0:
 - Main and auxiliary circuit: Either screw or spring-type terminals
- Sizes S2 and S3:
 - Main circuit: Screw terminals with box terminal or as straight-through transformer
 - Auxiliary circuit: Either screw or spring-type terminals

3RB2 electronic overload relays

3RB20 and 3RB21 overload relays:

- Size S6:
 - Main circuit: With busbar connection or as straight-through transformer
 - Auxiliary circuit: Either screw or spring-type terminals
- Sizes S10/S12:
 - Main circuit: With busbar connection
 - Auxiliary circuit: Either screw or spring-type terminals

3RB22 to 3RB24 evaluation modules:

- Screw or spring-type terminals

3RB29 current measuring modules:

- Up to size S3: Straight-through transformers
- As from size S6:
 - Main circuit: With busbar connection
 - Auxiliary circuit: Either screw or spring-type terminals



Screw terminals



Spring-type terminals



Busbar connections



Straight-through transformers

The various terminals and straight-through transformers are indicated in the corresponding tables by the symbols shown on orange backgrounds.

Overload Relays

SIRIUS 3RU2 Thermal Overload Relays

3RU2 for standard applications

Overview

More information

Home page, see <http://www.siemens.com/sirius-overloadrelays>
 Industry Mall, see www.siemens.com/product?3RU2
 Conversion tool, e.g. from 3RU11 to 3RU21, see www.siemens.com/sirius/conversion-tool

Application Manual "SIRIUS Controls with IE3/IE4 Motors", see <https://support.industry.siemens.com/cs/ww/en/view/94770820>
 Manual "SIRIUS – SIRIUS 3RU Thermal Overload Relays / SIRIUS 3RB Electronic Overload Relays", see <http://support.automation.siemens.com/WW/view/en/60298164>
 Characteristics and certificates, see <https://support.industry.siemens.com/cs/ww/en/ps/16271>

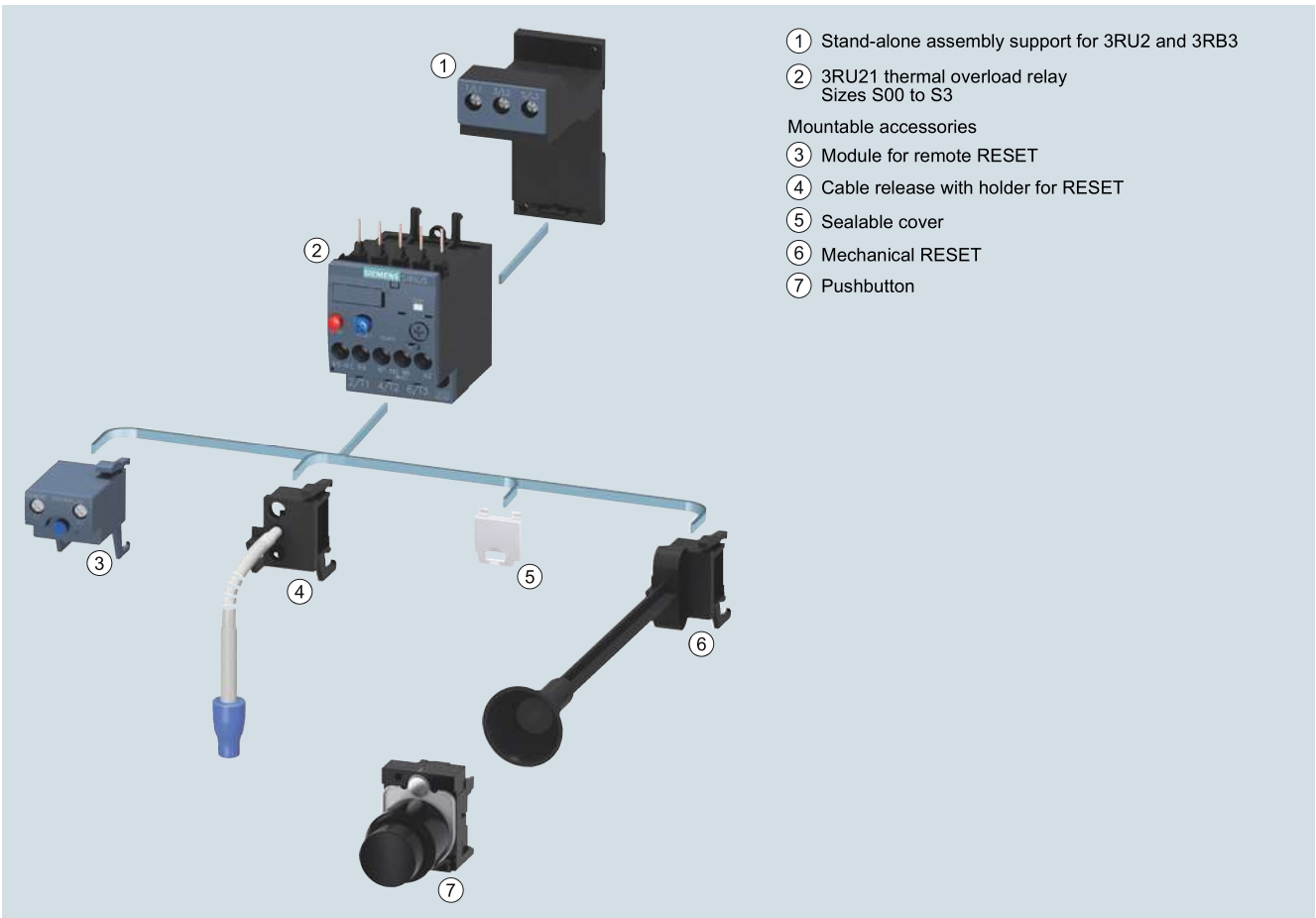

Mountable accessories for 3RU thermal overload relay

Overload Relays

SIRIUS 3RU2 Thermal Overload Relays

3RU2 for standard applications

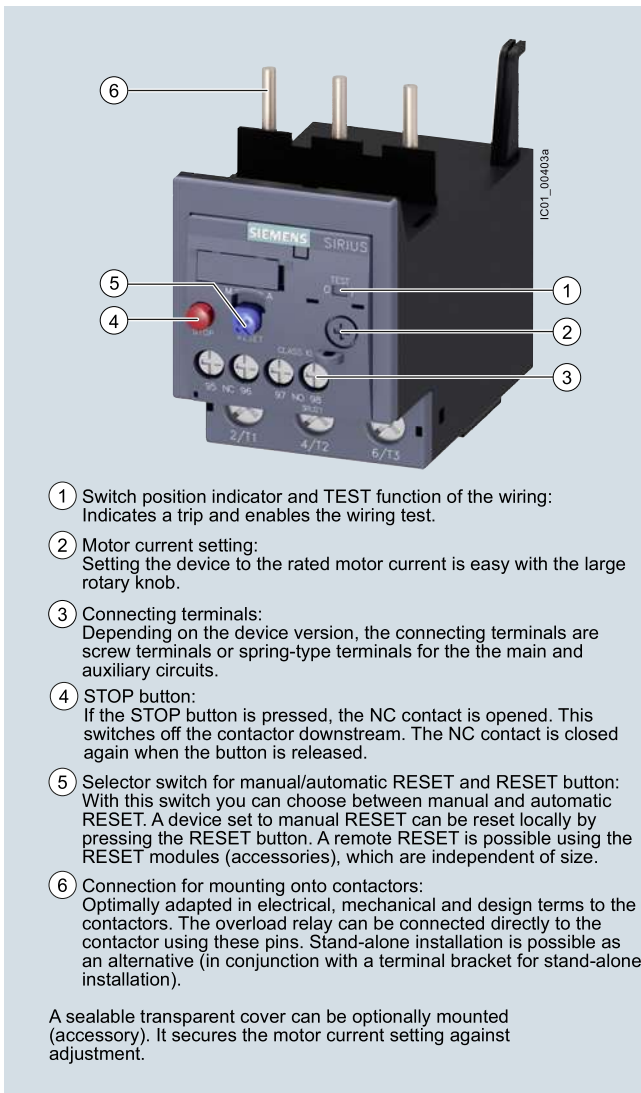

- ① Switch position indicator and TEST function of the wiring:
Indicates a trip and enables the wiring test.
- ② Motor current setting:
Setting the device to the rated motor current is easy with the large rotary knob.
- ③ Connecting terminals:
Depending on the device version, the connecting terminals are screw terminals or spring-type terminals for the main and auxiliary circuits.
- ④ STOP button:
If the STOP button is pressed, the NC contact is opened. This switches off the contactor downstream. The NC contact is closed again when the button is released.
- ⑤ Selector switch for manual/automatic RESET and RESET button:
With this switch you can choose between manual and automatic RESET. A device set to manual RESET can be reset locally by pressing the RESET button. A remote RESET is possible using the RESET modules (accessories), which are independent of size.
- ⑥ Connection for mounting onto contactors:
Optimally adapted in electrical, mechanical and design terms to the contactors. The overload relay can be connected directly to the contactor using these pins. Stand-alone installation is possible as an alternative (in conjunction with a terminal bracket for stand-alone installation).

A sealable transparent cover can be optionally mounted (accessory). It secures the motor current setting against adjustment.

3RU21 thermal overload relays up to 100 A have been designed to provide current-dependent protection for loads with normal starting against impermissibly high temperature rises due to overload or phase failure.

An overload or phase failure results in an increase of the motor current beyond the set rated motor current. Via heating elements, this current rise heats up the bimetal strips inside the device which then bend and as a result trigger the auxiliary contacts by means of a tripping mechanism. The auxiliary contacts then switch off the load by means of a contactor. The break time depends on the ratio between the tripping current and the current setting I_e and is stored in the form of a long-term stable tripping characteristic curve, see [Characteristic curves](#).

The "tripped" status is signaled by means of a switch position indicator. The relay is reset manually or automatically after a recovery time has elapsed.

The 3RU2 thermal overload relays are suitable for operation with frequency converters.

The devices are manufactured in accordance with environmental guidelines and contain environmentally friendly and reusable materials. They comply with all important worldwide standards and approvals.

Use in hazardous areas

The 3RU2 overload relays are certified in accordance with the European explosion protection directive (ATEX) and the international explosion protection standard (IECEx), see [Certificates](#).

SIRIUS 3RU2136-4.B0 thermal overload relay

Article No. scheme

Product versions		Article number	
Thermal overload relays		3RU2	<input type="checkbox"/> <input type="checkbox"/> <input type="checkbox"/> - <input type="checkbox"/> <input type="checkbox"/> <input type="checkbox"/> <input type="checkbox"/>
Device type	e. g. 1 = CLASS 10, 1 NO + 1 NC	<input type="checkbox"/>	
Size, rated operational current and power	e. g. 16 = 16 A (7.5 kW) for size S00	<input type="checkbox"/> <input type="checkbox"/>	
Setting range for overload release	e. g. 0A = 0.11 ... 0.16 A		<input type="checkbox"/> <input type="checkbox"/>
Connection methods	e.g. B = screw terminals		<input type="checkbox"/>
Installation type	e. g. 0 = mounting on contactor		<input type="checkbox"/>
Example		3RU2	1 1 6 - 0 A B 0

Note:

The Article No. scheme shows an overview of product versions for better understanding of the logic behind the article numbers.

For your orders please use the article numbers quoted in the selection and ordering data.

Overload Relays

SIRIUS 3RU2 Thermal Overload Relays

3RU2 for standard applications

Benefits

The most important features and benefits of the 3RU21 thermal overload relays are listed in the overview table (see "General Data", page 7/71 onwards).

Application

Industries

The 3RU21 thermal overload relays are suitable for customers from all industries who want to guarantee optimum inverse-time delayed protection of their electrical loads (e.g. motors) under normal starting conditions (CLASS 10, 10A).

Application

The 3RU21 thermal overload relays have been designed for the protection of three-phase and single-phase AC and DC motors.

If single-phase AC or DC loads are to be protected by the 3RU21 thermal overload relays, all three bimetal strips must be heated. For this purpose, all main current paths of the relay must be connected in series.

Ambient conditions

3RU21 thermal overload relays compensate temperature in the temperature range from -40 °C to $+60\text{ °C}$ according to IEC 60947-4-1. At temperatures from $+60\text{ °C}$ to $+70\text{ °C}$, the upper set value of the setting range has to be reduced by a specific factor in accordance with the table below.

Use of SIRIUS protection devices in conjunction with IE3/IE4 motors

Note:

For the use of 3RU21 thermal overload relays in conjunction with highly energy-efficient IE3/IE4 motors, please observe the information on dimensioning and configuring. see [Application Manual](#).

For more information, see [Preface on page 7](#).



Technical specifications

More information

System Manual "SIRIUS – System Overview", see <https://support.industry.siemens.com/cs/ww/en/view/60311318>
 Configuration Manual "Configuring SIRIUS Innovations – Selection Data for Fuseless and Fused Load Feeders", see <https://support.industry.siemens.com/cs/ww/en/view/39714188>

Manual "SIRIUS – SIRIUS 3RU Thermal Overload Relays / SIRIUS 3RB Electronic Overload Relays", see <https://support.industry.siemens.com/cs/ww/en/view/60298164>
 Technical specifications, see <https://support.industry.siemens.com/cs/ww/en/ps/16270/td>

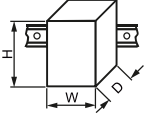
The following technical information is intended to provide an initial overview of the various types of device and functions.

Type		3RU2116	3RU2126	3RU2136	3RU2146
Size		S00	S0	S2	S3
Dimensions (W x H x D) (overload relay with stand-alone installation support)					
• Screw terminals	mm	45 x 89 x 80	45 x 97 x 95	55 x 105 x 117	70 x 106 x 124
• Spring-type terminals	mm	45 x 102 x 79	45 x 114 x 95	55 x 105 x 117	70 x 106 x 124
General data					
Tripping in the event of		Overload and phase failure			
Trip class acc. to IEC 60947-4-1	Class	10		10, 10A	
Phase failure sensitivity		Yes			
Overload warning		No			
Reset and recovery					
• Reset options after tripping		Manual, Automatic and Remote RESET (Remote RESET in conjunction with the appropriate accessory)			
• Recovery time					
- For automatic RESET	min.	Depends on the strength of the tripping current and characteristic			
- For manual RESET	min.	Depends on the strength of the tripping current and characteristic			
- For remote RESET	min.	Depends on the strength of the tripping current and characteristic			
Features					
• Display of operating state on device		Yes, by means of TEST function/switch position indicator slide			
• TEST function		Yes			
• RESET button		Yes			
• STOP button		Yes			
Protection of motors in hazardous environments					
• according to European Directive 2014/34/EU (ATEX)		DMT 98 ATEX G 001  II (2) GD			
• according to international standard IECEx		IECEx BVS 15.0046 see https://support.industry.siemens.com/cs/ww/en/ps/16270/cert			

Overload Relays

SIRIUS 3RU2 Thermal Overload Relays

3RU2 for standard applications

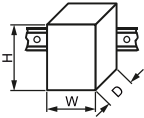
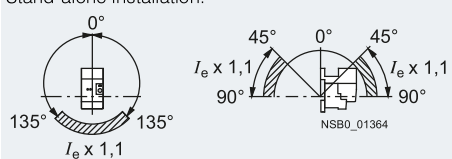
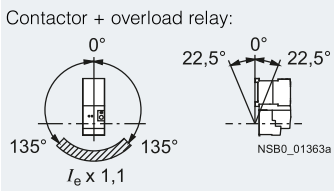
Type		3RU2116	3RU2126	3RU2136	3RU2146
Size		S00	S0	S2	S3
Dimensions (W x H x D) (overload relay with stand-alone installation support)					
• Screw terminals	mm	45 x 89 x 80	45 x 97 x 95	55 x 105 x 117	70 x 106 x 124
• Spring-type terminals	mm	45 x 102 x 79	45 x 114 x 95	55 x 105 x 117	70 x 106 x 124
General data (continued)					
Ambient temperature					
• Storage/transport	°C	-55 ... +80			
• Operation	°C	-40 ... +70			
• Temperature compensation	°C	Up to +60			
• Permissible rated current at					
- Temperature inside control cabinet 60 °C	%	100 (current reduction is required above +60 °C)			
- Temperature inside control cabinet 70 °C	%	87			
Repeat terminals					
• Coil repeat terminals		Yes	Not required		
• Auxiliary contact repeat terminal		Yes	Not required		
Degree of protection acc. to IEC 60529					
		IP20		- IP20 (front side) - Terminal IP00 (use additional terminal covers for higher degree of protection)	
Touch protection acc. to IEC 60529					
		Finger-safe			
Shock resistance with sine acc. to IEC 60068-2-27					
	g/ms	15/11 (auxiliary contacts 95/96 and 97/98: 8 g/11 ms)			
Electromagnetic compatibility (EMC)					
• Interference immunity		Not relevant			
• Emitted interference		Not relevant			
Resistance to extreme climates – air humidity					
	%	90			
Installation altitude above sea level					
	m	Up to 2 000			
Mounting position					
		<p>The diagrams show the permissible mounting positions for mounting onto contactors and stand-alone installation. For mounting position in the hatched area, a setting correction of 10 % must be implemented.</p> <p>Stand-alone installation:</p>  <p>Contactor + overload relay:</p> 			
Type of mounting					
		For mounting onto contactor or stand-alone installation with terminal support, screw and snap-on mounting onto standard mounting rail.			

Overload Relays

SIRIUS 3RU2 Thermal Overload Relays

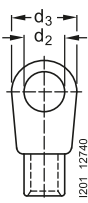

3RU2 for standard applications

Type		3RU2116	3RU2126	3RU2136	3RU2146
Size		S00	S0	S2	S3
Main circuit					
Rated insulation voltage U_i (pollution degree 3)	V	690			1000
Rated impulse withstand voltage U_{imp}	kV	6			8
Rated operational voltage U_e	V	690			
Type of current		Yes			
• Direct current		Yes			
• Alternating current		Yes, frequency range up to 400 Hz			
Current setting	A	0.11 ... 0.16 up to 11 ... 16	1.8 ... 2.5 up to 34 ... 40	11 ... 16 up to 70 ... 80	28 ... 40 up to 80 ... 100
Power loss per unit (max.)	W	4.1 ... 6.3	6.2 ... 7.5	8 ... 14	12 ... 16.5
Short-circuit protection					
• With fuse without contactor		See "Selection and ordering data", pages 7/84 ... 7/87			
• With fuse and contactor		"Short-Circuit Protection with Fuses/Motor Starter Protectors for Motor Feeders" see Configuration Manual.			
Protective separation between main and auxiliary current paths					
Acc. to IEC 60947-1					
• Screw terminals or ring terminal lug connections	V	440	690: Setting range ≤ 25 A	690	
• Spring-type terminals	V	440	440: Setting range > 25 A	690	
Conductor cross-sections of main circuit					
Connection type		⊕ Screw terminals			⊕ Screw terminals with box terminal
Terminal screw		M3, Pozidriv size 2	M4, Pozidriv size 2	M6, Pozidriv size 2	4 mm Allen screw
Operating devices	mm	∅ 5 ... 6	∅ 5 ... 6	∅ 5 ... 6	4 mm Allen screw
Prescribed tightening torque	Nm	0.8 ... 1.2	2 ... 2.5	3 ... 4.5	4.5 ... 6
Conductor cross-sections (min./max.), 1 or 2 conductors can be connected					
• Solid or stranded	mm ²	2 x (0.5 ... 1.5) ¹⁾ , 2 x (0.75 ... 2.5) ¹⁾ , max. 2 x 4	2 x (1 ... 2.5) ¹⁾ , 2 x (2.5 ... 10) ¹⁾	2 x (2.5 ... 35) ¹⁾ , 1 x (2.5 ... 50) ¹⁾	2 x (2.5 ... 16) ¹⁾ , 2 x (10 ... 50) ¹⁾ , 1 x (10 ... 70) ¹⁾
• Finely stranded with end sleeve (DIN 46228-1)	mm ²	2 x (0.5 ... 1.5) ¹⁾ , 2 x (0.75 ... 2.5) ¹⁾	2 x (1 ... 2.5) ¹⁾ , 2 x (2.5 ... 6) ¹⁾ ; max.. 1 x 10	2 x (1 ... 25) ¹⁾ , 1 x (1 ... 35) ¹⁾	2 x (2.5 ... 35) ¹⁾ , 1 x (2.5 ... 50) ¹⁾
• AWG cables, solid or stranded	AWG	2 x (20 ... 16) ¹⁾ , 2 x (18 ... 14) ¹⁾ , 2 x 12	2 x (16 ... 12) ¹⁾ , 2 x (14 ... 8) ¹⁾	2 x (18 ... 2) ¹⁾ , 1 x (18 ... 1) ¹⁾	2 x (10 ... 1/0) ¹⁾ , 1 x (10 ... 2/0) ¹⁾
Removable box terminals²⁾					
• With copper bars ³⁾	mm	--	--	--	2 x 12 x 4
• With cable lugs ⁴⁾					
- Terminal screw		--	--	--	M6
- Prescribed tightening torque	Nm	--	--	--	4.5 ... 6
- Usable ring terminal lugs	mm	--	--	--	d ₂ = min. 6.3 d ₃ = max. 19
					
Connection type		⊖ Spring-type terminals			
Operating devices	mm	3.0 x 0.5 and 3.5 x 0.5			
Conductor cross-sections (min./max.), 1 conductor can be connected					
• Solid or stranded	mm ²	1 x (0.5 ... 4)	1 x (1 ... 10)	--	
• Finely stranded without end sleeve	mm ²	1 x (0.5 ... 2.5)	1 x (1 ... 6)	--	
• Finely stranded with end sleeve (DIN 46228-1)	mm ²	1 x (0.5 ... 2.5)	1 x (1 ... 6)	--	
• AWG cables, solid or stranded	AWG	1 x (20 ... 12)	1 x (18 ... 8)	--	
¹⁾ If two different conductor cross-sections are connected to one clamping point, both cross-sections must be in the range specified. ²⁾ Cable lug and busbar connection possible after removing the box terminals. ³⁾ If bars larger than 12 mm x 10 mm are connected, a 3RT2946-4EA2 cover is needed to maintain the required phase clearance, see page 7/89. ⁴⁾ When conductors larger than 25 mm ² are connected, the 3RT2946-4EA2 cover is needed to maintain the required phase clearance, see page 7/89.					

Overload Relays

SIRIUS 3RU2 Thermal Overload Relays

3RU2 for standard applications

Type		3RU2116	3RU2126	3RU2136	3RU2146
Size		S00	S0	S2	S3
Auxiliary circuit					
Number of NO contacts		1			
Number of NC contacts		1			
Auxiliary contacts – assignment		1 NO for the signal "tripped"; 1 NC for disconnecting the contactor			
Rated insulation voltage U_i (pollution degree 3)	V	690			
Rated impulse withstand voltage U_{imp}	kV	6			
Contact rating of the auxiliary contacts					
<ul style="list-style-type: none"> NC, NO contact with alternating current AC-15, rated operational current I_e at U_e <ul style="list-style-type: none"> - 24 V - 120 V - 125 V - 230 V - 400 V - 600 V - 690 V NC, NO contacts with DC current DC-13, rated operational current I_e at U_e <ul style="list-style-type: none"> - 24 V - 110 V - 125 V - 220 V Contact reliability (suitability for PLC control; 17 V, 5 mA) 					
	A	3			
	A	3			
	A	3			
	A	2			
	A	1			
	A	0.75			
	A	0.75			
	A	1			
	A	0.22			
	A	0.22			
	A	0.11			
		Yes			
Short-circuit protection					
<ul style="list-style-type: none"> With fuse <ul style="list-style-type: none"> - Operational class gG - Quick With miniature circuit breaker (C characteristic) 					
	A	6			
	A	10			
	A	6 (up to $I_k \leq 0.5$ kA; $U \leq 260$ V)			
Permissible operational voltage for protective separation between auxiliary current paths Acc. to IEC 60947-1	V	440			
CSA, UL, UR rated data					
Auxiliary circuit – switching capacity		B600, R300			
Conductor cross-sections for auxiliary circuit					
Connection type		 Screw terminals			
Terminal screw		M3, Pozidriv size 2			
Operating devices		mm	∅ 5 ... 6		
Prescribed tightening torque		Nm	0.8 ... 1.2		
Conductor cross-sections (min./max.), 1 or 2 conductors can be connected					
<ul style="list-style-type: none"> Solid or stranded 	mm ²	2 x (0.5 ... 1.5) ¹⁾ , 2 x (0.75 ... 2.5) ¹⁾			
<ul style="list-style-type: none"> Finely stranded with end sleeve (DIN 46228-1) 	mm ²	2 x (0.5 ... 1.5) ¹⁾ , 2 x (0.75 ... 2.5) ¹⁾			
<ul style="list-style-type: none"> AWG cables, solid or stranded 	AWG	2 x (20 ... 16) ¹⁾ , 2 x (18 ... 14) ¹⁾			
Connection type		 Spring-type terminals			
Operating devices		mm	3.0 x 0.5 and 3.5 x 0.5		
Conductor cross-sections (min./max.), 1 or 2 conductors can be connected					
<ul style="list-style-type: none"> Solid or stranded 	mm ²	2 x (0.5 ... 2.5)			
<ul style="list-style-type: none"> Finely stranded without end sleeve 	mm ²	2 x (0.5 ... 2.5)			
<ul style="list-style-type: none"> Finely stranded with end sleeve (DIN 46228-1) 	mm ²	2 x (0.5 ... 1.5)			
<ul style="list-style-type: none"> AWG cables, solid or stranded 	AWG	2 x (20 ... 14)			

¹⁾ If two different conductor cross-sections are connected to one clamping point, both cross-sections must be in the range specified.

Overload Relays SIRIUS 3RU2 Thermal Overload Relays

IE3/IE4 ready 3RU2 for standard applications

3RU21 thermal overload relays for mounting onto contactor¹⁾, sizes S2 and S3, CLASS 10 or 10A

Features and technical specifications:

- Connection methods
 - Main circuit: Screw terminals with box terminal
 - Auxiliary circuit: Either screw or spring-type terminals
- Overload and phase failure protection
- Auxiliary contacts 1 NO + 1 NC
- Manual and automatic RESET
- Switch position indicator

- TEST function
- STOP button
- Sealable covers (optional accessory)

PU (UNIT, SET, M) = 1
 PS* = 1 unit
 PG = 41F



Size contactor	Trip class	Rated power for three-phase motors, rated value ²⁾	Current setting value of the inverse-time delayed overload release	Short-circuit protection with fuse, type of coordination "2", operational class gG ³⁾	SD	Screw terminals		Spring-type terminals (on auxiliary current side)		
						Article No.	Price per PU	Article No.	Price per PU	
Class	kW	A	A	d						
Size S2										
S2	10	7.5	11 ... 16	40	5	3RU2136-4AB0	5	3RU2136-4AD0	5	
	10	7.5	14 ... 20	50	5	3RU2136-4BB0	5	3RU2136-4BD0	5	
	10	11	18 ... 25	63	5	3RU2136-4DB0	5	3RU2136-4DD0	5	
	10	15	22 ... 32	80	5	3RU2136-4EB0	5	3RU2136-4ED0	5	
	10	18.5	28 ... 40	80	5	3RU2136-4FB0	5	3RU2136-4FD0	5	
	10	22	36 ... 45	100	5	3RU2136-4GB0	5	3RU2136-4GD0	5	
	10	22	40 ... 50	100	5	3RU2136-4HB0	5	3RU2136-4HD0	5	
	10	30	47 ... 57	100	5	3RU2136-4QB0	5	3RU2136-4QD0	5	
	10	30	54 ... 65	125	5	3RU2136-4JB0	5	3RU2136-4JD0	5	
	10A	37	62 ... 73	160	5	3RU2136-4KB0	5	3RU2136-4KD0	5	
	10A	37	70 ... 80	160	5	3RU2136-4RB0	5	3RU2136-4RD0	5	
	Size S3 NEW									
	S3	10	18.5	28 ... 40	80	1	3RU2146-4FB0	5	3RU2146-4FD0	5
		10	22	36 ... 50	125	1	3RU2146-4HB0	5	3RU2146-4HD0	5
10		30	45 ... 63	125	1	3RU2146-4JB0	1	3RU2146-4JD0	1	
10		37	57 ... 75	160	1	3RU2146-4KB0	1	3RU2146-4KD0	1	
10		45	70 ... 90	160	1	3RU2146-4LB0	1	3RU2146-4LD0	1	
10		45	80 ... 100 ⁴⁾	200	1	3RU2146-4MB0	1	3RU2146-4MD0	1	

¹⁾ With the appropriate terminal supports (see "Accessories", page 7/88), the 3RU2 overload relays for mounting on contactors can also be installed as stand-alone units.

²⁾ Guide value for 4-pole standard motors at 50 Hz 400 V AC. The actual starting and rated data of the motor to be protected must be considered when selecting the units.

³⁾ Maximum protection by fuse only for overload relays, type of coordination "2". For fuse values in connection with contactors, see Configuration Manual.

⁴⁾ For overload relays > 100 A, see 3RB2 electronic overload relays, page 7/102 onwards.

Overload Relays

SIRIUS 3RU2 Thermal Overload Relays

3RU2 for standard applications **IE3/IE4 ready**

3RU21 thermal overload relays for stand-alone installation, sizes S00 and S0, CLASS 10

Features and technical specifications:

- Connection methods
Main and auxiliary circuit: Either screw or spring-type terminals
- Overload and phase failure protection
- Auxiliary contacts 1 NO + 1 NC
- Manual and automatic RESET

- Switch position indicator
- TEST function
- STOP button
- Sealable covers (optional accessory)

PU (UNIT, SET, M) = 1
PS* = 1 unit
PG = 41F

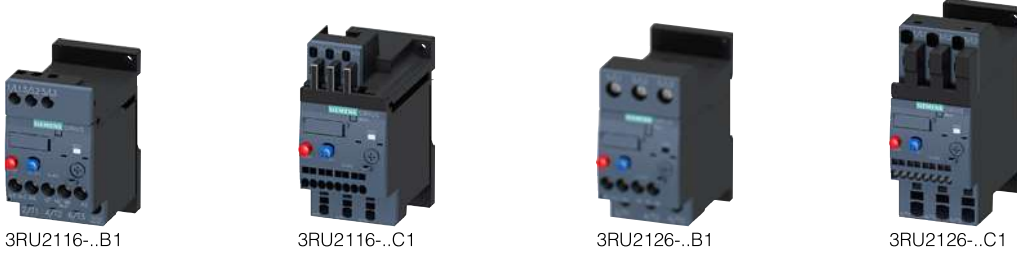

Size contac- tor	Trip class	Rated power for three-phase motors, rated value ¹⁾	Current setting value of the inverse-time delayed overload release	Short-circuit protection with fuse, type of coordination "2", operational class gG ²⁾	SD	Screw terminals		Spring-type terminals	
						Article No.	Price per PU	Article No.	Price per PU
Class	kW	A	A	d					
Size S00									
S00	10	0.04	0.11 ... 0.16	0.5	5	3RU2116-0AB1	5	3RU2116-0AC1	
	10	0.06	0.14 ... 0.2	1	5	3RU2116-0BB1	5	3RU2116-0BC1	
	10	0.06	0.18 ... 0.25	1	5	3RU2116-0CB1	5	3RU2116-0CC1	
	10	0.09	0.22 ... 0.32	1.6	5	3RU2116-0DB1	5	3RU2116-0DC1	
	10	0.09	0.28 ... 0.4	2	5	3RU2116-0EB1	5	3RU2116-0EC1	
	10	0.12	0.35 ... 0.5	2	5	3RU2116-0FB1	5	3RU2116-0FC1	
	10	0.18	0.45 ... 0.63	2	5	3RU2116-0GB1	5	3RU2116-0GC1	
	10	0.18	0.55 ... 0.8	4	5	3RU2116-0HB1	5	3RU2116-0HC1	
	10	0.25	0.7 ... 1	4	5	3RU2116-0JB1	5	3RU2116-0JC1	
	10	0.37	0.9 ... 1.25	4	5	3RU2116-0KB1	5	3RU2116-0KC1	
	10	0.55	1.1 ... 1.6	6	5	3RU2116-1AB1	5	3RU2116-1AC1	
	10	0.75	1.4 ... 2	6	5	3RU2116-1BB1	5	3RU2116-1BC1	
	10	0.75	1.8 ... 2.5	10	5	3RU2116-1CB1	5	3RU2116-1CC1	
	10	1.1	2.2 ... 3.2	10	5	3RU2116-1DB1	5	3RU2116-1DC1	
	10	1.5	2.8 ... 4	16	5	3RU2116-1EB1	5	3RU2116-1EC1	
	10	1.5	3.5 ... 5	20	5	3RU2116-1FB1	5	3RU2116-1FC1	
	10	2.2	4.5 ... 6.3	20	5	3RU2116-1GB1	5	3RU2116-1GC1	
	10	3	5.5 ... 8	25	5	3RU2116-1HB1	5	3RU2116-1HC1	
	10	4	7 ... 10	35	5	3RU2116-1JB1	5	3RU2116-1JC1	
	10	5.5	9 ... 12.5	35	5	3RU2116-1KB1	5	3RU2116-1KC1	
10	7.5	11 ... 16	40	5	3RU2116-4AB1	5	3RU2116-4AC1		
Size S0									
S0	10	7.5	14 ... 20	50	5	3RU2126-4BB1	5	3RU2126-4BC1	
	10	11	17 ... 22	63	5	3RU2126-4CB1	5	3RU2126-4CC1	
	10	11	20 ... 25	63	5	3RU2126-4DB1	5	3RU2126-4DC1	
	10	15	23 ... 28	63	5	3RU2126-4NB1	5	3RU2126-4NC1	
	10	15	27 ... 32	80	5	3RU2126-4EB1	5	3RU2126-4EC1	
	10	18.5	30 ... 36	80	5	3RU2126-4PB1	5	3RU2126-4PC1	
	10	18.5	34 ... 40	80	5	3RU2126-4FB1	5	3RU2126-4FC1	

¹⁾ Guide value for 4-pole standard motors at 50 Hz 400 V AC. The actual starting and rated data of the motor to be protected must be considered when selecting the units.

²⁾ Maximum protection by fuse only for overload relays, type of coordination "2". For fuse values in connection with contactors, see [Configuration Manual](#).

Overload Relays SIRIUS 3RU2 Thermal Overload Relays

IE3/IE4 ready 3RU2 for standard applications

3RU21 thermal overload relays for stand-alone installation, sizes S2 and S3, CLASS 10 or 10A

Features and technical specifications:

- Connection methods
 - Main circuit: Screw terminals with box terminal
 - Auxiliary circuit: Either screw or spring-type terminals
- Auxiliary contacts 1 NO + 1 NC
- Manual and automatic RESET
- Switch position indicator

- TEST function
- STOP button
- Sealable covers (optional accessory)

PU (UNIT, SET, M) = 1
 PS* = 1 unit
 PG = 41F



3RU2136-.B1



3RU2136-.D1



3RU2146-.B1



3RU2146-.D1

Size contactor	Trip class	Rated power for three-phase motors, rated value ¹⁾	Current setting value of the inverse-time delayed overload release	Short-circuit protection with fuse, type of coordination "2", operational class gG ²⁾	SD	Screw terminals		Spring-type terminals		
						Article No.	Price per PU	Article No.	Price per PU	
CLASS		kW	A	A	d					
Size S2										
S2	10	15	22 ... 32	80	5	3RU2136-4EB1	5	3RU2136-4ED1		
	10	18.5	28 ... 40	80	5	3RU2136-4FB1	5	3RU2136-4FD1		
	10	22	36 ... 45	100	▶	3RU2136-4GB1	▶	3RU2136-4GD1		
	10	22	40 ... 50	100	▶	3RU2136-4HB1	▶	3RU2136-4HD1		
	10	30	47 ... 57	100	▶	3RU2136-4QB1	▶	3RU2136-4QD1		
	10	30	54 ... 65	125	▶	3RU2136-4JB1	▶	3RU2136-4JD1		
	10A	37	62 ... 73	160	▶	3RU2136-4KB1	▶	3RU2136-4KD1		
	10A	37	70 ... 80	160	▶	3RU2136-4RB1	▶	3RU2136-4RD1		
	Size S3 NEW									
	S3	10	30	45 ... 63	125	1	3RU2146-4JB1	5	3RU2146-4JD1	
10		37	57 ... 75	160	1	3RU2146-4KB1	5	3RU2146-4KD1		
10		45	70 ... 90	160	1	3RU2146-4LB1	5	3RU2146-4LD1		
10		45	80 ... 100 ³⁾	200	1	3RU2146-4MB1	X	3RU2146-4MD1		

¹⁾ Guide value for 4-pole standard motors at 50 Hz 400 V AC. The actual starting and rated data of the motor to be protected must be considered when selecting the units.

²⁾ Maximum protection by fuse only for overload relays, type of coordination "2". For fuse values in connection with contactors, see Configuration Manual.

³⁾ For overload relays > 100 A, see 3RB2 electronic overload relays, page 7/102 onwards.

Overload Relays

SIRIUS 3RU2 Thermal Overload Relays







Accessories

Overview

The following optional accessories are available for the 3RU21 thermal overload relays:

- Size-specific terminal support for stand-alone installation, in sizes S00 and S0 also with spring-type terminals
- Mechanical RESET (for all sizes)
- Cable release for resetting devices which are difficult to access (for all sizes)
- Electrical remote RESET module in three voltage variants (for all sizes)
- Sealable cover (for all sizes)
- Terminal covers for devices with screw terminals (box terminals) and ring terminal lug connections





Selection and ordering data

Version	Size	SD	Article No.	Price per PU	PU (UNIT, SET, M)	PS*	PG	
Terminal supports for stand-alone installation								
 3RU2916-3AA01	Terminal supports for overload relays with screw terminals							
	For separate mounting of the overload relays; screw and snap-on mounting onto standard mounting rail		S00 ▶	3RU2916-3AA01		1	1 unit	41F
			S0 ▶	3RU2926-3AA01		1	1 unit	41F
			S2 ▶	3RU2936-3AA01		1	1 unit	41F
			S3 NEW 1	3RU2946-3AA01		1	1 unit	41F
 3RU2926-3AA01	Terminal supports for overload relays with spring-type terminals							
	For separate mounting of the overload relays; screw and snap-on mounting onto standard mounting rail		S00 5	3RU2916-3AC01		1	1 unit	41F
 3RU2936-3AA01			S0 5	3RU2926-3AC01		1	1 unit	41F
 3RU2946-3AA01								
 3RU2916-3AC01								
 3RU2926-3AC01								
Mechanical RESET								
 3RU2900-1A with pushbutton and extension plunger	Resetting plungers, holders and formers		S00 ... S3 ▶	3RU2900-1A		1	1 unit	41F
	Pushbuttons with extended stroke (12 mm), IP65, ∅ 22 mm		S00 ... S3 ▶	3SU1200-0FB10-0AA0		1	1 unit	41J
	Extension plungers For compensation of the distance between the pushbutton and the unlatching button of the relay		S00 ... S3 ▶	3SU1900-0KG10-0AA0		1	1 unit	41J



Overload Relays

SIRIUS 3RU2 Thermal Overload Relays

Accessories

Version	Size	SD	Article No.	Price per PU	PU (UNIT, SET, M)	PS*	PG
Cable releases with holder for RESET							
 <p>3RU2900-1.</p>	For \varnothing 6.5 mm holes in the control panel; max. control panel thickness 8 mm						
	<ul style="list-style-type: none"> Length 400 mm Length 600 mm 	S00 ... S3 ▶	3RU2900-1B	1	1 unit	41F	
		S00 ... S3 ▶	3RU2900-1C	1	1 unit	41F	
Modules for remote RESET, electrical							
 <p>3RU1900-2A.71</p>	Operating range 0.85 ... 1.1 x U_{s1} , power consumption 80 VA AC, 70 W DC, ON period 0.2 ... 4 s, switching frequency 60/h						
	<ul style="list-style-type: none"> 24 ... 30 V AC/DC 110 ... 127 V AC/DC 220 ... 250 V AC/DC 	S00 ... S3 2	3RU1900-2AB71	1	1 unit	41F	
		S00 ... S3 2	3RU1900-2AF71	1	1 unit	41F	
		S00 ... S3 2	3RU1900-2AM71	1	1 unit	41F	
Sealable covers							
 <p>3RV2908-0P</p>	For covering the setting knobs		S00 ... S3 ▶	3RV2908-0P	100	10 units	41E
Terminal covers							
 <p>3RT2936-4EA2</p>	Covers for devices with screw terminals (box terminals) Additional touch protection for fastening to the box terminals			Screw terminals 			
	<ul style="list-style-type: none"> Main current level 	S2 2	3RT2936-4EA2	1	1 unit	41B	
		S3 NEW ▶	3RT2946-4EA2	1	1 unit	41B	

General accessories

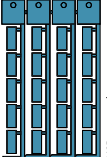
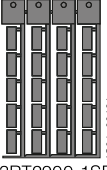
Version	Size	Color	For overload relays	SD	Article No.	Price per PU	PU (UNIT, SET, M)	PS*	PG	
Tools for opening spring-type terminals										
 <p>3RA2908-1A</p>	Screwdrivers For all SIRIUS devices with spring-type terminals		Length approx. 200 mm, 3.0 mm x 0.5 mm	Titanium gray/black, partially insulated	Main and auxiliary circuit connection: 3RU2	2				
							Spring-type terminals 	1	1 unit	41B
Blank labels										
 <p>3RT1900-1SB20</p>	Unit labeling plates¹⁾ For SIRIUS devices		20 mm x 7 mm	Pastel turquoise	3RU2	20	3RT1900-1SB20	100	340 units	41B
			20 mm x 7 mm	Titanium gray	3RU2	20	3RT2900-1SB20	100	340 units	41B
			19 mm x 6 mm	Pastel turquoise	3RU2	15	3RT1900-1SB60	100	3 060 units	41B
			19 mm x 6 mm	Zinc yellow	3RU2	15	3RT1900-1SD60	100	3 060 units	41B
 <p>3RT2900-1SB20</p>										

¹⁾ PC labeling system for individual inscription of unit labeling plates available from: murrplastik Systemtechnik GmbH (see page 16/20).

Overload Relays

SIRIUS 3RB3 Electronic Overload Relays

3RB30, 3RB31 for standard applications

Overview

More information

Home page, see <http://www.siemens.com/sirius-overloadrelays>
 Industry Mall, see www.siemens.com/product?3RB3
 Conversion tool, e.g. from 3RB20/3RB211 to 3RB30/3RB31, see www.siemens.com/sirius/conversion-tool

Application Manual "SIRIUS Controls with IE3/IE4 Motors", see <https://support.industry.siemens.com/cs/ww/en/view/94770820>
 Manual "SIRIUS – SIRIUS 3RU Thermal Overload Relays / SIRIUS 3RB Electronic Overload Relays", see <https://support.industry.siemens.com/cs/ww/en/view/60298164>
 Characteristics and certificates, see <https://support.industry.siemens.com/cs/ww/en/ps/16276>

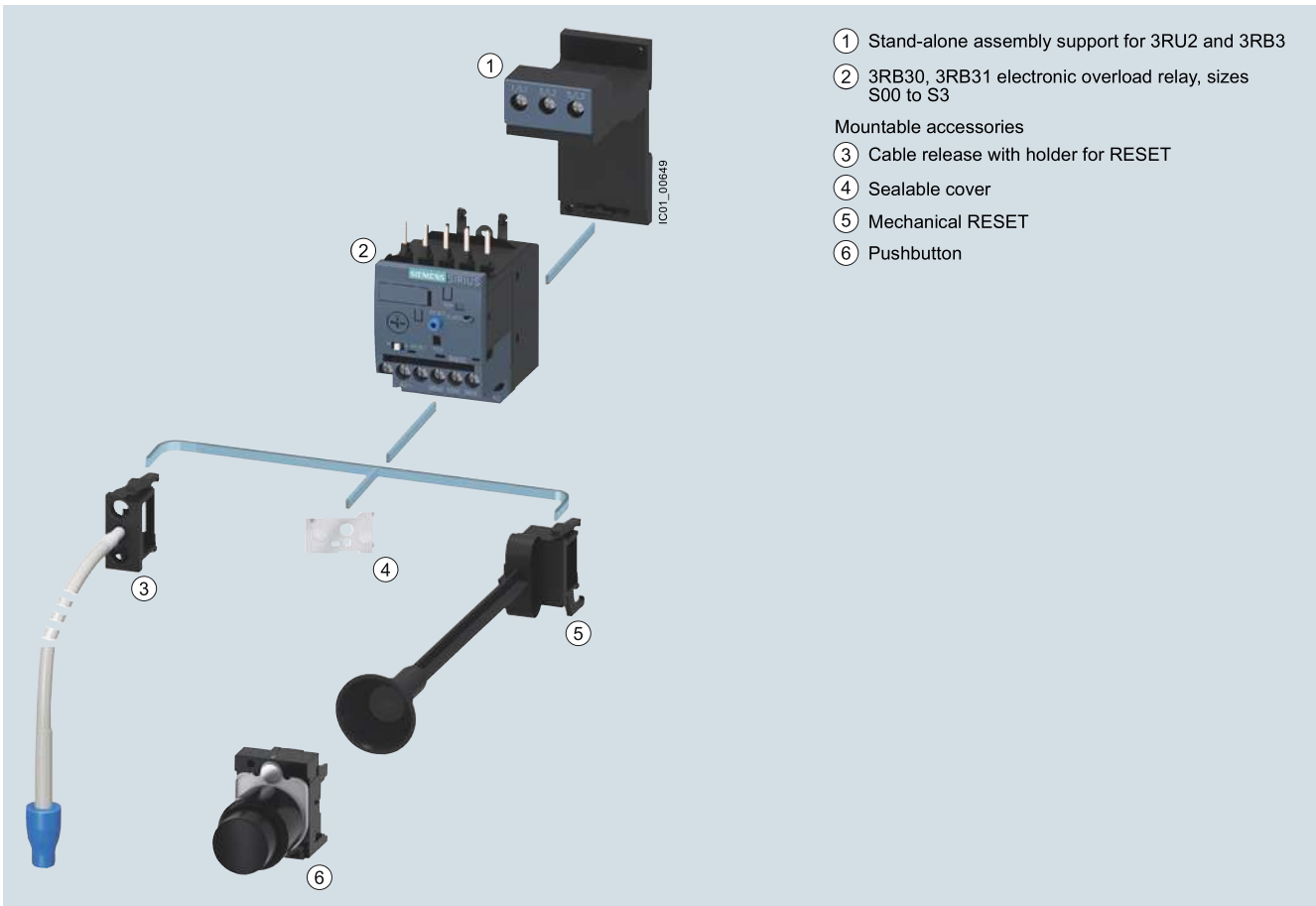

Mountable accessories for 3RB30 and 3RB31 electronic overload relays

Overload Relays

SIRIUS 3RB3 Electronic Overload Relays

3RB30, 3RB31 for standard applications

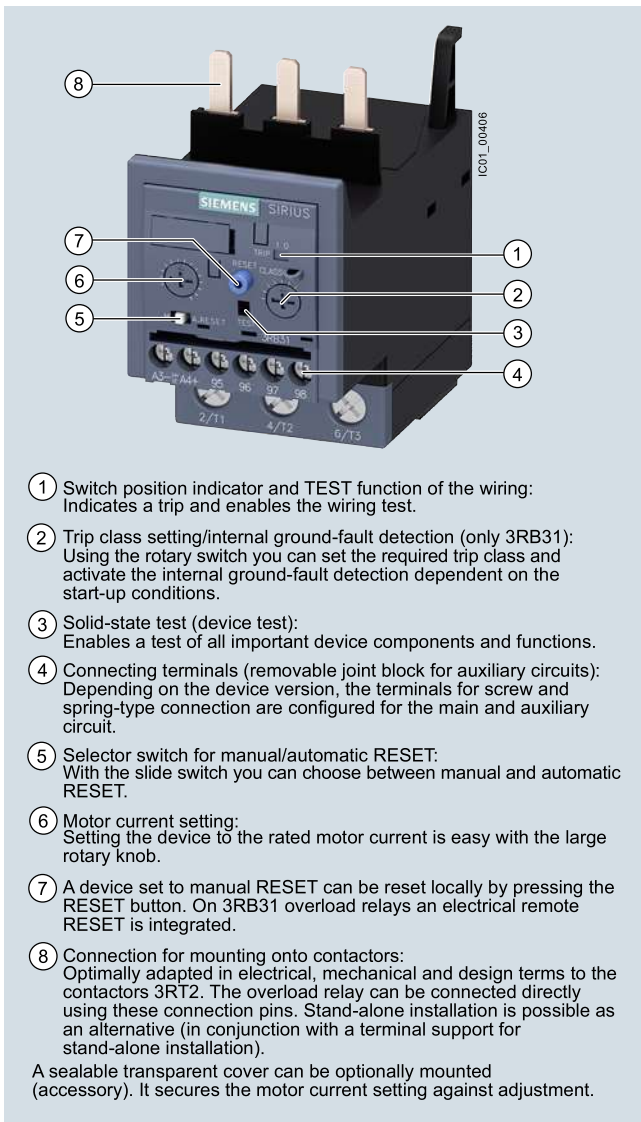

- ① Switch position indicator and TEST function of the wiring:
Indicates a trip and enables the wiring test.
- ② Trip class setting/internal ground-fault detection (only 3RB31):
Using the rotary switch you can set the required trip class and activate the internal ground-fault detection dependent on the start-up conditions.
- ③ Solid-state test (device test):
Enables a test of all important device components and functions.
- ④ Connecting terminals (removable joint block for auxiliary circuits):
Depending on the device version, the terminals for screw and spring-type connection are configured for the main and auxiliary circuit.
- ⑤ Selector switch for manual/automatic RESET:
With the slide switch you can choose between manual and automatic RESET.
- ⑥ Motor current setting:
Setting the device to the rated motor current is easy with the large rotary knob.
- ⑦ A device set to manual RESET can be reset locally by pressing the RESET button. On 3RB31 overload relays an electrical remote RESET is integrated.
- ⑧ Connection for mounting onto contactors:
Optimally adapted in electrical, mechanical and design terms to the contactors 3RT2. The overload relay can be connected directly using these connection pins. Stand-alone installation is possible as an alternative (in conjunction with a terminal support for stand-alone installation).

A sealable transparent cover can be optionally mounted (accessory). It secures the motor current setting against adjustment.

The 3RB30/3RB31 electronic overload relays up to 115 A with internal power supply have been designed for current-dependent protection of loads with normal and heavy starting, and to protect against excessive temperature rises due to overload, phase asymmetry or phase failure. An overload, phase asymmetry or phase failure result in an increase of the motor current beyond the set rated motor current. This current rise is detected by the current transformers integrated into the devices and evaluated by corresponding solid-state circuits which then output a pulse to the auxiliary contacts. The auxiliary contacts then switch off the load by means of a contactor. The break time depends on the ratio between the tripping current and the current setting I_e and is stored in the form of a long-term stable tripping characteristic curve, (see [Characteristic curves](#)).

In addition to inverse-time delayed protection of loads against excessive temperature rises due to overload, phase asymmetry and phase failure, the 3RB31 electronic overload relays also allow internal ground-fault detection (not possible in conjunction with contactor assemblies for wye-delta starting). This provides protection of loads against high-resistance short circuits due to damage to the insulation material, moisture, condensed water etc.

The "tripped" status is signaled by means of a switch position indicator. The relay is reset manually or automatically after the recovery time has elapsed.

The 3RB3 electronic overload relays are suitable for operation with frequency converters.

The devices are manufactured in accordance with environmental guidelines and contain environmentally friendly and reusable materials. They comply with all important worldwide standards and approvals.

3RB20 and 3RB21 overload relays in sizes S6 to S10/S12, see [page 7/109 onwards](#).

Use in hazardous areas

The 3RB30/3RB31 electronic overload relays are suitable for the overload protection of motors with the following types of protection:

- II (2) G [Ex e] [Ex d] [Ex px]
- II (2) D [Ex t] [Ex p]

EC type test certificate for Group II, Category (2) G/D exists. It has the number PTB 09 ATEX 3001.

SIRIUS 3RB3133-4.B0 electronic overload relay

Overload Relays

SIRIUS 3RB3 Electronic Overload Relays

3RB30, 3RB31 for standard applications

Article No. scheme

Product versions	Article number
Electronic overload relays	3RB3 <input type="checkbox"/> <input type="checkbox"/> <input type="checkbox"/> - <input type="checkbox"/> <input type="checkbox"/> <input type="checkbox"/> <input type="checkbox"/>
Device type	e. g. 0 = standard device, with internal supply, for three-phase loads <input type="checkbox"/>
Size, rated operational current and power	e. g. 1 = 16 A (7.5 kW) for size S00 <input type="checkbox"/>
Version of the automatic RESET, electrical remote RESET	e. g. 6 = switchable between manual/auto RESET <input type="checkbox"/>
Trip class (CLASS)	e. g. 1 = CLASS 10E <input type="checkbox"/>
Setting range of the overload release	e.g. R = 0.1 ... 0.4 A <input type="checkbox"/>
Connection methods	e.g. B = screw terminals for main and auxiliary circuits <input type="checkbox"/>
Installation type	e. g. 0 = mounting on contactor <input type="checkbox"/>
Example	3RB3 0 1 6 - 1 R B 0

Note:

The Article No. scheme shows an overview of product versions for better understanding of the logic behind the article numbers.

For your orders please use the article numbers quoted in the selection and ordering data.

Benefits

The most important features and benefits of the 3RB30/3RB31 electronic overload relays are listed in the overview table (see "General Data" page 7/71 onwards).

Advantages through energy efficiency

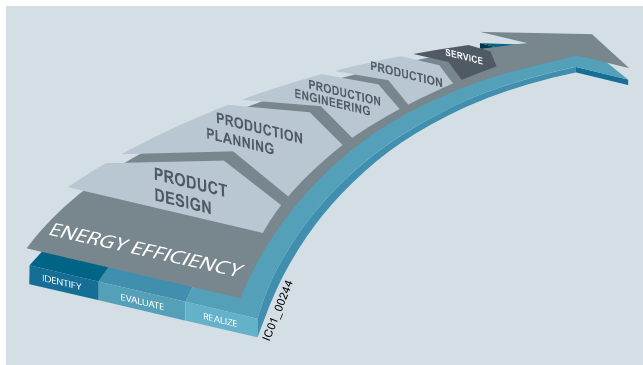

Overview of the energy management process

We offer you a unique portfolio for industrial energy management, using an energy management system that helps to optimally define your energy needs. We split up our industrial energy management into three phases – identify, evaluate, and realize – and we support you with the appropriate hardware and software solutions in every process phase.

The innovative products of the SIRIUS industrial controls portfolio can also make a substantial contribution to a plant's energy efficiency (see www.siemens.com/sirius/energysaving).

3RB30/3RB31 electronic overload relays contribute to energy efficiency throughout the plant as follows:

- Reduced inherent power loss
- Less heating of the control cabinet
- Smaller control cabinet air conditioners can be used

Application

Industries

The 3RB30/3RB31 electronic overload relays are suitable for customers from all industries who want to guarantee optimum in-verse-time delayed protection of their electrical loads (e.g. motors) under normal and heavy starting conditions (CLASS 5E to 30E), minimize project completion times, inventories and energy consumption, and optimize plant availability and maintenance management.

Application

The 3RB30/3RB31 electronic overload relays have been designed for the protection of three-phase motors in sinusoidal 50/60 Hz voltage networks. The relays are not suitable for the protection of single-phase AC or DC loads.

The 3RU21 thermal overload relay or the 3RB22/3RB23/3RB24 electronic overload relay can be used for single-phase AC loads. For DC loads we recommend the 3RU21 thermal overload relay.

Ambient conditions

The devices are insensitive to external influences such as shocks, corrosive ambient conditions, ageing and temperature fluctuations.

For the temperature range from -25 °C to $+60\text{ °C}$, the 3RB30/3RB31 electronic overload relays compensate the temperature in accordance with IEC 60947-4-1.

Use of SIRIUS protection devices in conjunction with IE3/IE4 motors

Note:

For the use of 3RB30/3RB31 electronic overload relays in conjunction with highly energy-efficient IE3/IE4 motors, please observe the information on dimensioning and configuring, see [Application Manual](#).

For more information, see [Preface on page 7](#).

Overload Relays

SIRIUS 3RB3 Electronic Overload Relays

3RB30, 3RB31 for standard applications

Technical specifications

More information

System Manual "SIRIUS – System Overview", see <https://support.industry.siemens.com/cs/ww/en/view/60311318>

Configuration Manual "Configuring SIRIUS Innovations – Selection Data for Fuseless and Fused Load Feeders", see <https://support.industry.siemens.com/cs/ww/en/view/39714188>

Manual "SIRIUS – SIRIUS 3RU Thermal Overload Relays / SIRIUS 3RB Electronic Overload Relays", see <https://support.industry.siemens.com/cs/ww/en/view/60298164>

Technical specifications, see <https://support.industry.siemens.com/cs/ww/en/ps/16276/td>

The following technical information is intended to provide an initial overview of the various types of device and functions.

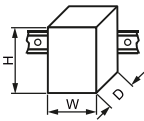
Type		3RB3016, 3RB3113	3RB3026, 3RB3123	3RB3036, 3RB3133	3RB3046, 3RB3143
Size		S00	S0	S2	S3
Dimensions (W x H x D) (overload relay with stand-alone installation support)					
• Screw terminals	mm	45 x 89 x 80	45 x 97 x 94	55 x 105 x 117	70 x 106 x 124
• Spring-type terminals	mm	45 x 102 x 80	45 x 116 x 95	55 x 105 x 117	70 x 106 x 124
General data					
Tripping in the event of		Overload, phase failure and phase asymmetry + ground fault (for 3RB31 only)			
Trip class acc. to IEC 60947-4-1	CLASS	3RB30: 10E, 20E; 3RB31: 5E, 10E, 20E or 30E adjustable			
Phase failure sensitivity		Yes			
Reset and recovery		Manual and automatic RESET, 3RB31 has an integrated connection for electrical remote RESET (24 V DC)			
• Reset options after tripping		Manual and automatic RESET, 3RB31 has an integrated connection for electrical remote RESET (24 V DC)			
• Recovery time		Approx. 3 min			
- For automatic RESET		Immediately			
- For manual RESET		Immediately			
- For remote RESET		Immediately			
Features		Yes, by means of switch position indicator slide			
• Display of operating state on device		Yes, by means of switch position indicator slide			
• TEST function		Yes, test of electronics by pressing the TEST button/test of auxiliary contacts and wiring of control circuit by actuating the switch position indicator slide/self-monitoring			
• RESET button		Yes			
• STOP button		No			
Protection and operation of explosion-proof motors		PTB 09 ATEX 3001 ⚠ II (2) G [Ex e] [Ex d] [Ex px] ⚠ II (2) G [Ex t] [Ex p] see https://support.industry.siemens.com/cs/ww/en/view/40591327			
Ambient temperatures		EC type-examination certificate number according to directive 2014/34/EU (ATEX)			
• Storage/transport	°C	-40 ... +80			
• Operation	°C	-25 ... +60			
• Temperature compensation	°C	+60			
• Permissible rated current at					
- Temperature inside control cabinet 60 °C	%	100			
- Temperature inside control cabinet 70 °C	%	On request			
Repeat terminals					
• Coil repeat terminals		Yes	Not required		
• Auxiliary contact repeat terminal		Yes	Not required		
Degree of protection acc. to IEC 60529					
• Screw terminals/spring-type terminals		IP20	- IP20 (front side) - Terminal IP00 (use additional terminal covers for higher degree of protection)		
• Straight-through transformers		--	IP20		
Touch protection acc. to IEC 60529		Finger-safe			
		Finger-safe			Finger-safe, for vertical contact from the front
Shock resistance with sine acc. to IEC 60068-2-27	g/ms	15/11 (signaling contact 97/98 in "Tripped" position: 9 g/11 ms)			
		15/11 (signaling contact 97/98 in "Tripped" position: 8 g/11 ms)			15/11 (signaling contact 97/98 in "Tripped" position: 8 g/11 ms)

Overload Relays

SIRIUS 3RB3 Electronic Overload Relays

3RB30, 3RB31 for standard applications

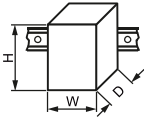
Type		3RB3016, 3RB3113	3RB3026, 3RB3123	3RB3036, 3RB3133	3RB3046, 3RB3143
Size		S00	S0	S2	S3
Dimensions (W x H x D) (overload relay with stand-alone installation support)					
• Screw terminals	mm	45 x 89 x 80	45 x 97 x 94	55 x 105 x 117	70 x 106 x 124
• Spring-type terminals	mm	45 x 102 x 80	45 x 116 x 95	55 x 105 x 117	70 x 106 x 124

General data (continued)

Electromagnetic compatibility (EMC) – Interference immunity					
• Conductor-related interference					
- Burst acc. to IEC 61000-4-4 (corresponds to degree of severity 3)	kV	2 (power ports), 1 (signal port)			
- Surge acc. to IEC 61000-4-5 (corresponds to degree of severity 3)	kV	2 (line to earth), 1 (line to line)			
• Electrostatic discharge according to IEC 61000-4-2 (corresponds to degree of severity 3)	kV	8 (air discharge), 6 (contact discharge)			
• Field-related interference acc. to IEC 61000-4-3 (corresponds to degree of severity 3)	V/m	10			
Electromagnetic compatibility (EMC) – Emitted interference		Degree of severity B acc. to EN 55011 (CISPR 11) and EN 55022 (CISPR 22)			
Resistance to extreme climates – air humidity	%	95			
Installation altitude above sea level	m	Up to 2 000			
Mounting position		Any			
Type of mounting		Direct mounting/stand-alone installation with terminal support			

Type		3RB3016, 3RB3113	3RB3026, 3RB3123	3RB3036, 3RB3133	3RB3046, 3RB3143
Size		S00	S0	S2	S3
Main circuit					
Rated insulation voltage U_i (pollution degree 3)	V	690		690 1 000 with straight-through transformer	1000
Rated impulse withstand voltage U_{imp}	kV	6		6 8 with straight-through transformer	8
Rated operational voltage U_e	V	690		690 1 000 with straight-through transformer	1000
Type of current					
• Direct current		No			
• Alternating current		Yes, 50/60 Hz \pm 5 %			
Current setting	A	0.1 ... 0.4 up to 4 ... 16	0.1 ... 0.4 up to 10 ... 40	12.5 ... 50 and 20 ... 80	12.5 ... 50 and 32 ... 115
Heavy starting		see Manual			
Power loss per unit (max.)	W	0.1 ... 1.1	0.1 ... 4.5	0.5 ... 4.6	0.9 ... 4.6
Short-circuit protection					
• With fuse without contactor		See "Selection and ordering data", pages 7/97 ... 7/99			
• With fuse and contactor		"Short-Circuit Protection with Fuses/Motor Starter Protectors for Motor Feeders" see Configuration Manual.			
Protective separation between main and auxiliary current paths acc. to IEC 60947-1 (pollution degree 2)					
• For systems with grounded neutral point	V	690			
• For systems with ungrounded neutral point	V	600			

Overload Relays

SIRIUS 3RB3 Electronic Overload Relays

3RB30, 3RB31 for standard applications

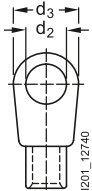
Type		3RB3016, 3RB3113	3RB3026, 3RB3123	3RB3036, 3RB3133	3RB3046, 3RB3143
Size		S00	S0	S2	S3
Conductor cross-sections of main circuit					
Connection type		⊕ Screw terminals			⊕ Screw terminals with box terminal
Terminal screw		M3, Pozidriv size 2	M4, Pozidriv size 2		4 mm Allen screw
Operating devices	mm	∅ 5 ... 6	∅ 5 ... 6		4 mm Allen screw
Prescribed tightening torque	Nm	0.8 ... 1.2	2 ... 2.5		4.5 ... 6
Conductor cross-sections (min./max.), 1 or 2 conductors can be connected					
• Solid or stranded	mm ²	2 x (0.5 ... 1.5) ¹⁾ , 2 x (0.75 ... 2.5) ¹⁾ , 2 x (0.5 ... 4) ¹⁾	2 x (1 ... 2.5) ¹⁾ , 2 x (2.5 ... 10) ¹⁾	1 x (1 ... 50) ¹⁾ , 2 x (1 ... 35) ¹⁾	2 x (2.5 ... 16) ¹⁾ , 2 x (10 ... 50) ¹⁾ , 1 x (10 ... 70) ¹⁾
• Finely stranded with end sleeve (DIN 46228-1)	mm ²	2 x (0.5 ... 1.5) ¹⁾ , 2 x (0.75 ... 2.5) ¹⁾	2 x (1 ... 2.5) ¹⁾ , 2 x (2.5 ... 6) ¹⁾ , max.. 1 x 10	2 x (1 ... 25) ¹⁾ , 1 x (1 ... 35) ¹⁾	2 x (2.5 ... 35) ¹⁾ , 1 x (2.5 ... 50) ¹⁾
• AWG cables, solid or stranded	AWG	2 x (20 ... 16) ¹⁾ , 2 x (18 ... 14) ¹⁾ , 2 x 12	2 x (16 ... 12) ¹⁾ , 2 x (14 ... 8) ¹⁾	2 x (18 ... 2) ¹⁾ , 1 x (18 ... 1) ¹⁾	2 x (10 ... 1/0) ¹⁾ , 1 x (10 ... 2/0) ¹⁾
Removable box terminals²⁾					
• With copper bars ³⁾	mm	--	--	--	2 x 12 x 4
• With cable lugs ⁴⁾					
- Terminal screw		--	--	--	M6
- Prescribed tightening torque	Nm	--	--	--	4.5 ... 6
- Usable ring terminal lugs	mm	--	--	--	d ₂ = min. 6.3 d ₃ = max. 19
					
Connection type		⊖ Spring-type terminals			
Operating devices	mm	3.0 x 0.5 and 3.5 x 0.5			
Conductor cross-sections (min./max.), 1 conductor can be connected					
• Solid or stranded	mm ²	1 x (0.5 ... 4)	1 x (1 ... 10)	--	--
• Finely stranded without end sleeve	mm ²	1 x (0.5 ... 2.5)	1 x (1 ... 6)	--	--
• Finely stranded with end sleeve (DIN 46228-1)	mm ²	1 x (0.5 ... 2.5)	1 x (1 ... 6)	--	--
• AWG cables, solid or stranded	AWG	1 x (20 ... 12)	1 x (18 ... 8)	--	--
Connection type					
⊖ Straight-through transformers					
Diameter of opening	mm	--		15	18

¹⁾ If two different conductor cross-sections are connected to one clamping point, both cross-sections must be in the range specified.

²⁾ Cable lug and busbar connection possible after removing the box terminals.

³⁾ If bars larger than 12 mm x 10 mm are connected, a 3RT2946-4EA2 cover is needed to maintain the required phase clearance, see page 7/101.



⁴⁾ When conductors larger than 25 mm² are connected, the 3RT2946-4EA2 cover is needed to maintain the required phase clearance, see page 7/101.

Overload Relays

SIRIUS 3RB3 Electronic Overload Relays

3RB30, 3RB31 for standard applications

Type		3RB3016, 3RB3113	3RB3026, 3RB3123	3RB3036, 3RB3133	3RB3046, 3RB3143
Size		S00	S0	S2	S3
Auxiliary circuit					
Number of NO contacts		1			
Number of NC contacts		1			
Auxiliary contacts – assignment		1 NO for the signal "tripped"; 1 NC for disconnecting the contactor			
Rated insulation voltage U_i (pollution degree 3)	V	300			
Rated impulse withstand voltage U_{imp}	kV	4			
Auxiliary contacts – contact rating					
• NC, NO contact with alternating current AC-14/AC-15, rated operational current I_e at U_e					
- 24 V	A	4			
- 120 V	A	4			
- 125 V	A	4			
- 250 V	A	3			
• NC, NO contacts with DC current DC-13, rated operational current I_e at U_e					
- 24 V	A	2			
- 60 V	A	0.55			
- 110 V	A	0.3			
- 125 V	A	0.3			
- 250 V	A	0.11			
• Conventional thermal current I_{th}	A	5			
• Contact reliability (suitability for PLC control; 17 V, 5 mA)		Yes			
Short-circuit protection					
• With fuse, operational class gG	A	6			
Ground-fault protection (only 3RB31)					
• Tripping value I_{Δ}		The information refers to sinusoidal residual currents at 50/60 Hz. > $0.75 \times I_{motor}$			
• Operating range I		Lower current setting < I_{motor} < $3.5 \times$ upper current setting			
• Response time t_{trip} (in steady-state condition)	s	< 1			
Integrated electrical remote RESET (only 3RB31)					
Connecting terminals A3, A4		24 V DC, max. 200 mA for approx. 20 ms, then < 10 mA			
Protective separation between auxiliary current paths acc. to IEC 60947-1	V	300			

Type		3RB3016, 3RB3113	3RB3026, 3RB3123	3RB3036, 3RB3133	3RB3046, 3RB3143
Size		S00	S0	S2	S3
CSA, UL, UR rated data					
Auxiliary circuit – switching capacity		B600, R300			
Conductor cross-sections for auxiliary circuit					
Connection type		 Screw terminals			
Terminal screw		M3, Pozidriv size 2			
Operating devices	mm	∅ 5 ... 6			
Prescribed tightening torque	Nm	0.8 ... 1.2			
Conductor cross-sections (min./max.), 1 or 2 conductors can be connected					
• Solid or stranded	mm ²	1 × (0.5 ... 4) ¹⁾ , 2 × (0.5 ... 2.5) ¹⁾			
• Finely stranded with end sleeve (DIN 46228-1)	mm ²	1 × (0.5 ... 2.5) ¹⁾ , 2 × (0.5 ... 1.5) ¹⁾			
• AWG cables, solid or stranded	AWG	2 × (20 ... 14)			
Connection type		 Spring-type terminals			
Operating devices	mm	3.0 × 0.5			
Conductor cross-sections (min./max.), 1 or 2 conductors can be connected					
• Solid or stranded	mm ²	2 × (0.25 ... 1.5)			
• Finely stranded without end sleeve	mm ²	2 × (0.25 ... 1.5)			
• Finely stranded with end sleeve (DIN 46228-1)	mm ²	2 × (0.25 ... 1.5)			
• AWG cables, solid or stranded	AWG	2 × (24 ... 16)			

¹⁾ If two different conductor cross-sections are connected to one clamping point, both cross-sections must be in the range specified.

Overload Relays SIRIUS 3RB3 Electronic Overload Relays

IE3/IE4 ready 3RB30, 3RB31 for standard applications

Selection and ordering data

3RB30 electronic overload relays, CLASS 10E

Features and technical specifications:

- Connection methods
 - Sizes S00 and S0:
Main and auxiliary circuit: Either screw or spring-type terminals
 - Sizes S2 and S3:
Main circuit: Screw terminals with box terminal or as straight-through transformer,
Auxiliary circuit: Either screw or spring-type terminals
- Overload protection, phase failure protection and asymmetry protection

- Internal power supply
- Auxiliary contacts 1 NO + 1 NC
- Manual and automatic RESET
- Switch position indicator
- TEST function and self-monitoring
- Sealable covers (optional accessory)

PU (UNIT, SET, M) = 1
PS* = 1 unit
PG = 41G



Size contactor	Rated power for three-phase motors, rated value ¹⁾	Current setting value of the inverse-time delayed overload release	Short-circuit protection with fuse, type of coordination "2", operational class gG ²⁾	SD	Screw terminals	SD	Spring-type terminals	
	kW	A	A	d	Article No.	Price per PU d	Article No.	Price per PU

Size S00

S00 *Devices for mounting onto contactor³⁾*

0.04 ... 0.09	0.1 ... 0.4	4	▶	3RB3016-1RB0	2	3RB3016-1RE0
0.12 ... 0.37	0.32 ... 1.25	6	▶	3RB3016-1NB0	2	3RB3016-1NE0
0.55 ... 1.5	1 ... 4	20	▶	3RB3016-1PB0	2	3RB3016-1PE0
1.1 ... 5.5	3 ... 12	25	▶	3RB3016-1SB0	2	3RB3016-1SE0
2.2 ... 7.5	4 ... 16	25	▶	3RB3016-1TB0	2	3RB3016-1TE0

Size S0

S0 *Devices for mounting onto contactor³⁾*

0.04 ... 0.09	0.1 ... 0.4	4	▶	3RB3026-1RB0	2	3RB3026-1RE0
0.12 ... 0.37	0.32 ... 1.25	6	▶	3RB3026-1NB0	2	3RB3026-1NE0
0.55 ... 1.5	1 ... 4	20	▶	3RB3026-1PB0	2	3RB3026-1PE0
1.1 ... 5.5	3 ... 12	25	▶	3RB3026-1SB0	2	3RB3026-1SE0
3 ... 11	6 ... 25	50	▶	3RB3026-1QB0	2	3RB3026-1QE0
5.5 ... 18.5	10 ... 40	50	▶	3RB3026-1VB0	2	3RB3026-1VE0

Size S2

S2 *Devices with screw terminals (main current side) and for mounting onto contactor³⁾*

7.5 ... 22	12.5 ... 50	250	▶	3RB3036-1UB0	▶	3RB3036-1UD0
11 ... 37	20 ... 80	250	▶	3RB3036-1WB0	▶	3RB3036-1WD0

Devices with straight-through transformer for stand-alone installation

7.5 ... 22	12.5 ... 50	250	▶	3RB3036-1UW1	▶	3RB3036-1UX1
11 ... 37	20 ... 80	250	▶	3RB3036-1WW1	▶	3RB3036-1WX1

Size S3 **NEW**

S3 *Devices with screw terminals (main current side) and for mounting onto contactor³⁾*

7.5 ... 22	12.5 ... 50	200	X	3RB3046-1UB0	X	3RB3046-1UD0
18.5 ... 55	32 ... 115	315	X	3RB3046-1XB0	X	3RB3046-1XD0

Devices with straight-through transformer for stand-alone installation

7.5 ... 22	12.5 ... 50	200	X	3RB3046-1UW1	X	3RB3046-1UX1
18.5 ... 55	32 ... 115	315	X	3RB3046-1XW1	X	3RB3046-1XX1

¹⁾ Guide value for 4-pole standard motors at 50 Hz 400 V AC. The actual starting and rated data of the motor to be protected must be considered when selecting the units.

²⁾ Maximum protection by fuse only for overload relays, type of coordination "2".
For fuse values in connection with contactors, see Configuration Manual.

³⁾ With the appropriate terminal supports (see "Accessories", page 7/100), these overload relays can also be installed as stand-alone units.

Note:

For reliable operational current, note derating information, see Manual.

Overload Relays

SIRIUS 3RB3 Electronic Overload Relays

3RB30, 3RB31 for standard applications **IE3/IE4 ready**

3RB30 electronic overload relays, CLASS 20E

Features and technical specifications:

- Connection methods
 - Sizes S00 and S0:
Main and auxiliary circuit: Either screw or spring-type terminals
 - Sizes S2 and S3:
Main circuit: Screw terminals with box terminal or as straight-through transformer,
Auxiliary circuit: Either screw or spring-type terminals
- Overload protection, phase failure protection and asymmetry protection

- Internal power supply
- Auxiliary contacts 1 NO + 1 NC
- Manual and automatic RESET
- Switch position indicator
- TEST function and self-monitoring
- Sealable covers (optional accessory)

PU (UNIT, SET, M) = 1
 PS* = 1 unit
 PG = 41G



Size	Rated power for three-phase motors, rated value ¹⁾	Current setting value of the inverse-time delayed overload release	Short-circuit protection with fuse, type of coordination "2", operational class gG ²⁾	SD	Screw terminals	SD	Spring-type terminals	
	kW	A	A	d	Article No.	Price per PU	Article No.	Price per PU

Size S00			
S00	Devices for mounting onto contactor³⁾		
	0.04 ... 0.09	0.1 ... 0.4	4
	0.12 ... 0.37	0.32 ... 1.25	6
	0.55 ... 1.5	1 ... 4	20
	1.1 ... 5.5	3 ... 12	25
	2.2 ... 7.5	4 ... 16	25

▶	3RB3016-2RB0	2	3RB3016-2RE0
▶	3RB3016-2NB0	2	3RB3016-2NE0
▶	3RB3016-2PB0	2	3RB3016-2PE0
▶	3RB3016-2SB0	2	3RB3016-2SE0
▶	3RB3016-2TB0	2	3RB3016-2TE0

Size S0			
S0	Devices for mounting onto contactor³⁾		
	0.04 ... 0.09	0.1 ... 0.4	4
	0.12 ... 0.37	0.32 ... 1.25	6
	0.55 ... 1.5	1 ... 4	20
	1.1 ... 5.5	3 ... 12	25
	3 ... 11	6 ... 25	50
	5.5 ... 18.5	10 ... 40	50

▶	3RB3026-2RB0	2	3RB3026-2RE0
▶	3RB3026-2NB0	2	3RB3026-2NE0
▶	3RB3026-2PB0	2	3RB3026-2PE0
▶	3RB3026-2SB0	2	3RB3026-2SE0
▶	3RB3026-2QB0	2	3RB3026-2QE0
▶	3RB3026-2VB0	2	3RB3026-2VE0

Size S2			
S2	Devices with screw terminals (main current side) and for mounting onto contactor³⁾		
	7.5 ... 22	12.5 ... 50	250
	11 ... 37	20 ... 80	250
	Devices with straight-through transformer for stand-alone installation		
	7.5 ... 22	12.5 ... 50	250
	11 ... 37	20 ... 80	250

▶	3RB3036-2UB0	▶	3RB3036-2UD0
▶	3RB3036-2WB0	▶	3RB3036-2WD0
▶	3RB3036-2UW1	▶	3RB3036-2UX1
▶	3RB3036-2WW1	▶	3RB3036-2WX1

Size S3 NEW			
S3	Devices with screw terminals (main current side) and for mounting onto contactor³⁾		
	7.5 ... 22	12.5 ... 50	200
	18.5 ... 55	32 ... 115	315
	Devices with straight-through transformer for stand-alone installation		
	7.5 ... 22	12.5 ... 50	200
	18.5 ... 55	32 ... 115	315

X	3RB3046-2UB0	X	3RB3046-2UD0
X	3RB3046-2XB0	X	3RB3046-2XD0
X	3RB3046-2UW1	X	3RB3046-2UX1
X	3RB3046-2XW1	X	3RB3046-2XX1

¹⁾ Guide value for 4-pole standard motors at 50 Hz 400 V AC. The actual starting and rated data of the motor to be protected must be considered when selecting the units.

²⁾ Maximum protection by fuse only for overload relays, type of coordination "2". For fuse values in connection with contactors, see Configuration Manual.

³⁾ With the appropriate terminal supports (see "Accessories", page 7/100), these overload relays can also be installed as stand-alone units.

Overload Relays

SIRIUS 3RB3 Electronic Overload Relays

IE3/IE4 ready 3RB30, 3RB31 for standard applications

3RB31 electronic overload relays, CLASS 5E, 10E, 20E or 30E (adjustable)

Features and technical specifications:

- Connection methods
 - Sizes S00 and S0: Main and auxiliary circuit: Either screw or spring-type terminals
 - Sizes S2 and S3: Main circuit: Screw terminals with box terminal or as straight-through transformer, Auxiliary circuit: Either screw or spring-type terminals
- Overload protection, phase failure protection and asymmetry protection
- Internal ground-fault detection (activatable)

- Internal power supply
- Auxiliary contacts 1 NO + 1 NC
- Manual and automatic RESET
- Electrical remote RESET integrated
- Switch position indicator
- TEST function and self-monitoring
- Sealable covers (optional accessory)

 PU (UNIT, SET, M) = 1
 PS* = 1 unit
 PG = 41G

3RB3113-4TB0

3RB3123-4VB0

3RB3133-4B0

3RB3133-4.W1

3RB3143-4.B0

3RB3143-4.W1

Size contactor	Rated power for three-phase motors, rated value ¹⁾	Current setting value of the inverse-time delayed overload release	Short-circuit protection with fuse, type of coordination "2", operational class gG ²⁾	SD	Screw terminals	SD	Spring-type terminals	
	kW	A	A	d	Article No.	Price per PU d	Article No.	Price per PU

Size S00

S00

Devices for mounting onto contactor³⁾

0.04 ... 0.09	0.1 ... 0.4	4	▶
0.12 ... 0.37	0.32 ... 1.25	6	▶
0.55 ... 1.5	1 ... 4	20	▶
1.1 ... 5.5	3 ... 12	25	▶
2.2 ... 7.5	4 ... 16	25	▶

▶	3RB3113-4RB0	2	▶	3RB3113-4RE0
▶	3RB3113-4NB0	2	▶	3RB3113-4NE0
▶	3RB3113-4PB0	2	▶	3RB3113-4PE0
▶	3RB3113-4SB0	2	▶	3RB3113-4SE0
▶	3RB3113-4TB0	2	▶	3RB3113-4TE0

Size S0

S0

Devices for mounting onto contactor³⁾

0.04 ... 0.09	0.1 ... 0.4	4	▶
0.12 ... 0.37	0.32 ... 1.25	6	▶
0.55 ... 1.5	1 ... 4	20	▶
1.1 ... 5.5	3 ... 12	25	▶
3 ... 11	6 ... 25	50	▶
5.5 ... 18.5	10 ... 40	50	▶

▶	3RB3123-4RB0	2	▶	3RB3123-4RE0
▶	3RB3123-4NB0	2	▶	3RB3123-4NE0
▶	3RB3123-4PB0	2	▶	3RB3123-4PE0
▶	3RB3123-4SB0	2	▶	3RB3123-4SE0
▶	3RB3123-4QB0	2	▶	3RB3123-4QE0
▶	3RB3123-4VB0	2	▶	3RB3123-4VE0

Size S2

S2

Devices with screw terminals (main current side) and for mounting onto contactor³⁾

7.5 ... 22	12.5 ... 50	250	▶
11 ... 37	20 ... 80	250	▶

▶	3RB3133-4UB0	▶	3RB3133-4UD0
▶	3RB3133-4WB0	▶	3RB3133-4WD0

Devices with straight-through transformer for stand-alone installation

7.5 ... 22	12.5 ... 50	250	▶
11 ... 37	20 ... 80	250	▶

▶	3RB3133-4UW1	▶	3RB3133-4UX1
▶	3RB3133-4WW1	▶	3RB3133-4WX1

Size S3 **NEW**

S3

Devices with screw terminals (main current side) and for mounting onto contactor³⁾

7.5 ... 22	12.5 ... 50	200	X
18.5 ... 55	32 ... 115	315	X

X	3RB3143-4UB0	X	3RB3143-4UD0
X	3RB3143-4XB0	X	3RB3143-4XD0

Devices with straight-through transformer for stand-alone installation

7.5 ... 22	12.5 ... 50	200	X
18.5 ... 55	32 ... 115	315	X

X	3RB3143-4UW1	X	3RB3143-4UX1
X	3RB3143-4XW1	X	3RB3143-4XX1

¹⁾ Guide value for 4-pole standard motors at 50 Hz 400 V AC. The actual starting and rated data of the motor to be protected must be considered when selecting the units.

²⁾ Maximum protection by fuse only for overload relays, type of coordination "2". For fuse values in connection with contactors, see Configuration Manual.

³⁾ With the appropriate terminal supports (see "Accessories", page 7/100), these overload relays can also be installed as stand-alone units.

Overload Relays

SIRIUS 3RB3 Electronic Overload Relays





Accessories

Overview

The following optional accessories are available for the 3RB30/3RB31 electronic overload relays:

- Size-specific terminal support for stand-alone installation, in sizes S00 and S0 also with spring-type terminals
- Mechanical RESET (for all sizes)
- Cable release for resetting devices which are difficult to access (for all sizes)
- Sealable cover (for all sizes)





Selection and ordering data

Version	Size	SD	Article No.	Price per PU	PU (UNIT, SET, M)	PS*	PG
Terminal supports for stand-alone installation							
Terminal supports for overload relays with screw terminals			Screw terminals 				
 3RU2916-3AA01	For separate mounting of the overload relays; screw and snap-on mounting onto standard mounting rail	S00	▶	3RU2916-3AA01	1	1 unit	41F
		S0	▶	3RU2926-3AA01	1	1 unit	41F
		S2	▶	3RU2936-3AA01	1	1 unit	41F
		S3	NEW	▶	3RU2946-3AA01	1	1 unit
Terminal supports for overload relays with spring-type terminals			Spring-type terminals 				
 3RU2926-3AC01	For separate mounting of the overload relays; screw and snap-on mounting onto standard mounting rail	S00	5	3RU2916-3AC01	1	1 unit	41F
		S0	5	3RU2926-3AC01	1	1 unit	41F
Mechanical RESET							
 3RB3980-0A with pushbutton and extension plungers	Resetting plungers, holders and formers	S00 ... S3	▶	3RB3980-0A	1	1 unit	41F
	Pushbuttons with extended stroke (12 mm), IP65, ∅ 22 mm	S00 ... S3	▶	3SU1200-0FB10-0AA0	1	1 unit	41J
	Extension plungers For compensation of the distance between a pushbutton and the unlatching button of the relay	S00 ... S3	▶	3SU1900-0KG10-0AA0	1	1 unit	41J



Overload Relays

SIRIUS 3RB3 Electronic Overload Relays

Accessories

Version	Size	SD	Article No.	Price per PU	PU (UNIT, SET, M)	PS*	PG
Cable releases with holder for RESET							
 <p>3RB3980-0.</p>	For \varnothing 6.5 mm holes in the control panel; max. control panel thickness 8 mm						
	<ul style="list-style-type: none"> Length 400 mm Length 600 mm 	S00 ... S3 ▶ S00 ... S3 ▶	3RB3980-0B 3RB3980-0C		1 1	1 unit 1 unit	41F 41F
Sealable covers							
 <p>3RB3984-0</p>	For covering the setting knobs		S00 ... S3 ▶	3RB3984-0	1	1 unit	41F
Terminal covers							
 <p>3RT2936-4EA2</p>	Covers for devices with screw terminals (box terminals)			Screw terminals 			
	Additional touch protection for fastening to the box terminals						
	<ul style="list-style-type: none"> Main current level 	S2 2 S3 NEW ▶	3RT2936-4EA2 3RT2946-4EA2		1 1	1 unit 1 unit	41B 41B

General accessories

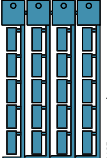
Version	Size	Color	For overload relays	SD	Article No.	Price per PU	PU (UNIT, SET, M)	PS*	PG	
Tools for opening spring-type terminals										
 <p>3RA2908-1A</p>	Screwdrivers				Spring-type terminals 					
	For all SIRIUS devices with spring-type terminals		Length, approx. 200 mm, 3.0 mm x 0.5 mm	Titanium gray/black, partially insulated	Main and auxiliary circuit connection: 3RB3	2	3RA2908-1A	1	1 unit	41B
Blank labels										
 <p>3RT1900-1SB20</p>	Unit labeling plates¹⁾									
	For SIRIUS devices		20 mm x 7 mm	Pastel turquoise	3RB3	20	3RT1900-1SB20	100	340 units	41B
			20 mm x 7 mm	Titanium gray	3RB3	20	3RT2900-1SB20	100	340 units	41B
	Adhesive inscription labels¹⁾		19 mm x 6 mm	Pastel turquoise	3RU2	15	3RT1900-1SB60	100	3 060 units	41B
	For SIRIUS devices		19 mm x 6 mm	Zinc yellow	3RU2	15	3RT1900-1SD60	100	3 060 units	41B

¹⁾ PC labeling system for individual inscription of unit labeling plates available from: murrplastik Systemtechnik GmbH (see page 16/20).

Overload Relays

SIRIUS 3RB2 Electronic Overload Relays

3RB20, 3RB21 for standard applications

Overview

More information

Home page, see <http://www.siemens.com/sirius-overloadrelays>
Industry Mall, see www.siemens.com/product?3RB2

Application Manual "SIRIUS Controls with IE3/IE4 Motors", see <https://support.industry.siemens.com/cs/ww/en/view/94770820>
Manual "SIRIUS – SIRIUS 3RU Thermal Overload Relays / SIRIUS 3RB Electronic Overload Relays", see <https://support.industry.siemens.com/cs/ww/en/view/60298164>
Characteristics and certificates, see <https://support.industry.siemens.com/cs/ww/en/ps/16278>

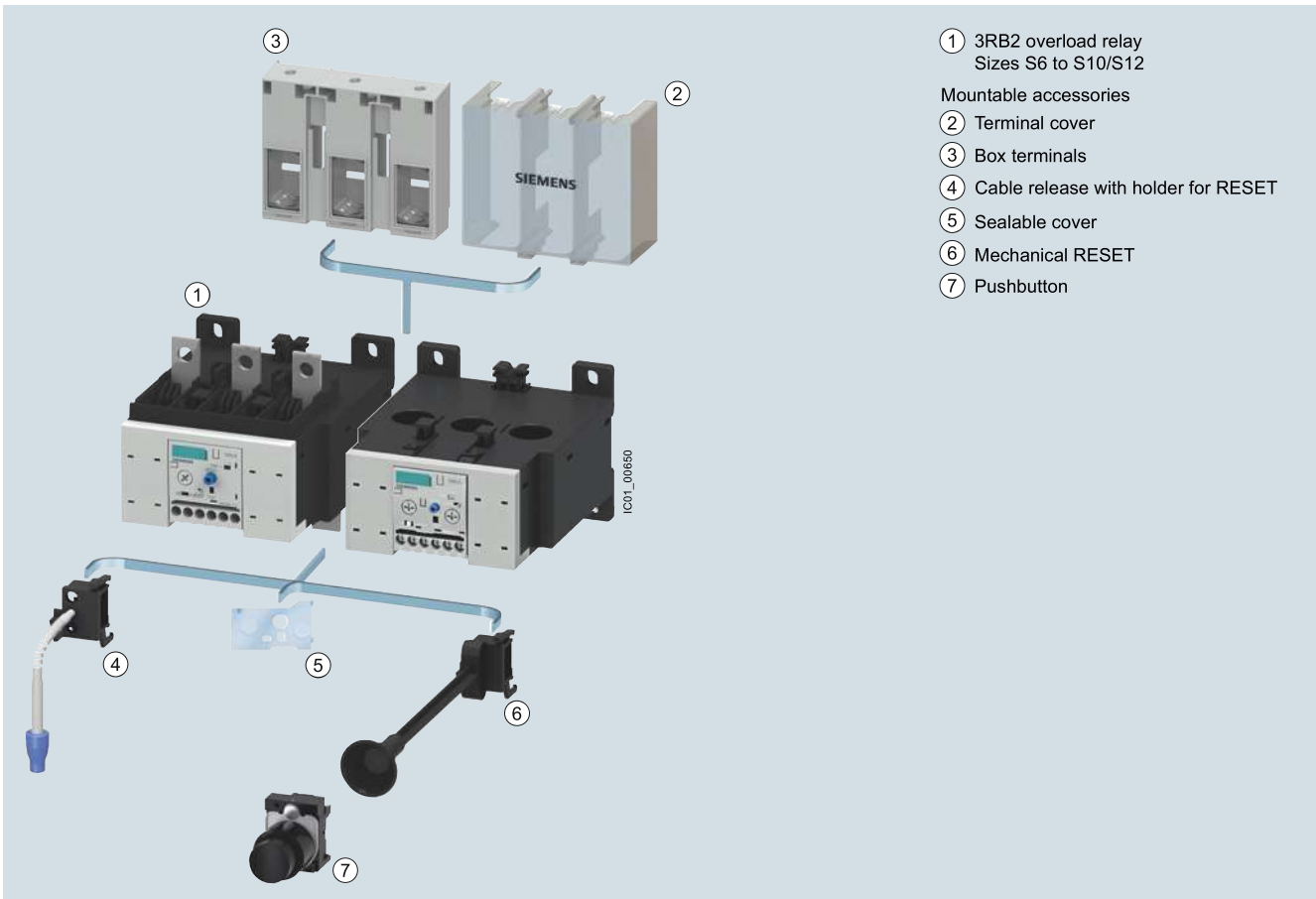

Mountable accessories for 3RB2 electronic overload relays (sizes S6 to S10/S12)

Overload Relays

SIRIUS 3RB2 Electronic Overload Relays

3RB20, 3RB21 for standard applications

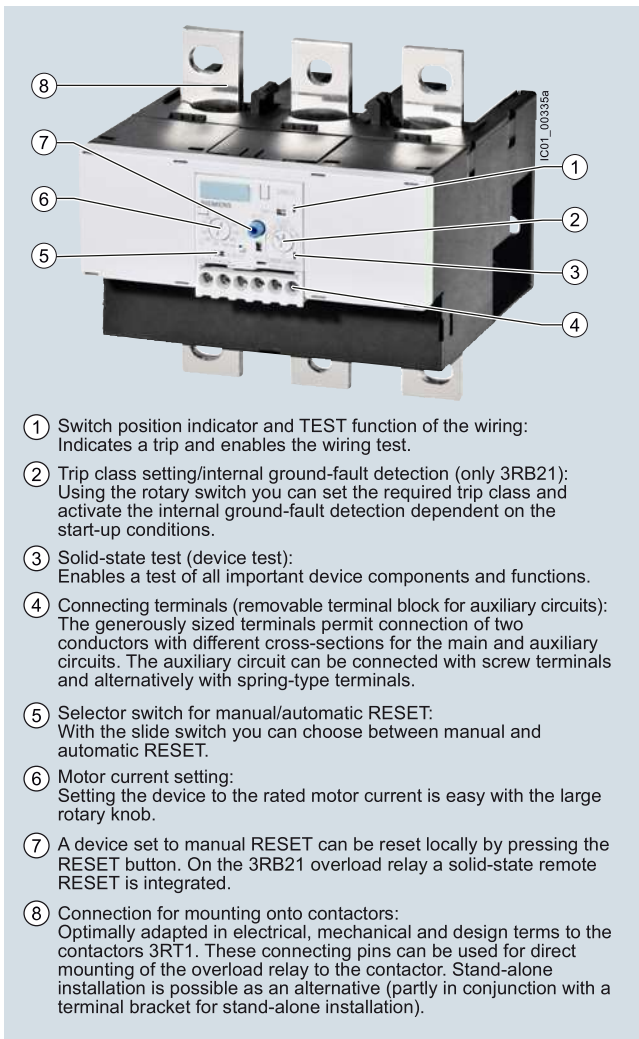

SIRIUS 3RB2153-4FW2 electronic overload relay

- ① Switch position indicator and TEST function of the wiring:
Indicates a trip and enables the wiring test.
- ② Trip class setting/internal ground-fault detection (only 3RB21):
Using the rotary switch you can set the required trip class and activate the internal ground-fault detection dependent on the start-up conditions.
- ③ Solid-state test (device test):
Enables a test of all important device components and functions.
- ④ Connecting terminals (removable terminal block for auxiliary circuits):
The generously sized terminals permit connection of two conductors with different cross-sections for the main and auxiliary circuits. The auxiliary circuit can be connected with screw terminals and alternatively with spring-type terminals.
- ⑤ Selector switch for manual/automatic RESET:
With the slide switch you can choose between manual and automatic RESET.
- ⑥ Motor current setting:
Setting the device to the rated motor current is easy with the large rotary knob.
- ⑦ A device set to manual RESET can be reset locally by pressing the RESET button. On the 3RB21 overload relay a solid-state remote RESET is integrated.
- ⑧ Connection for mounting onto contactors:
Optimally adapted in electrical, mechanical and design terms to the contactors 3RT1. These connecting pins can be used for direct mounting of the overload relay to the contactor. Stand-alone installation is possible as an alternative (partly in conjunction with a terminal bracket for stand-alone installation).

The 3RB20 and 3RB21 electronic overload relays up to 630 A with internal power supply have been designed for current-dependent protection of loads with normal and heavy starting (see [Manual](#)) against excessive temperature rises due to overload, phase asymmetry or phase failure.

An overload, phase asymmetry or phase failure result in an increase of the motor current beyond the set rated motor current. This current rise is detected by the current transformers integrated into the devices and evaluated by corresponding solid-state circuits which then output a pulse to the auxiliary contacts. The auxiliary contacts then switch off the load by means of a contactor. The break time depends on the ratio between the tripping current and the current setting I_{e} and is stored in the form of a long-term stable tripping characteristic curve, see [Characteristic curves](#).

In addition to inverse-time delayed protection of loads against excessive temperature rises due to overload, phase asymmetry and phase failure, the 3RB21 electronic overload relays also allow internal ground-fault detection (not possible in conjunction with contactor assemblies for star-delta (wye-delta) starting). This provides protection of loads against high-resistance short circuits due to damage to the insulation material, moisture, condensed water etc.

The "tripped" status is signaled by means of a switch position indicator. The relay is reset manually or automatically after the recovery time has elapsed.

The 3RB2 electronic overload relays are suitable for operation with frequency converters, see [Manual](#).

The devices are manufactured in accordance with environmental guidelines and contain environmentally friendly and reusable materials. They comply with all important worldwide standards and approvals.

For 3RB30 and 3RB31 overload relay sizes S00 to S3, see [page 7/97 onwards](#).

Use in hazardous areas

The 3RB20/3RB21 electronic overload relays are suitable for the overload protection of motors with the following types of protection:

- II (2) G [Ex e] [Ex d] [Ex px]
- II (2) D [Ex t] [Ex p]

EC type test certificate for Group II, Category (2) G/D exists. It has the number PTB 06 ATEX 3001.

Overload Relays

SIRIUS 3RB2 Electronic Overload Relays

3RB20, 3RB21 for standard applications

Article No. scheme

Product versions	Article number
Electronic overload relays	3RB2 <input type="checkbox"/> <input type="checkbox"/> <input type="checkbox"/> - <input type="checkbox"/> <input type="checkbox"/> <input type="checkbox"/> <input type="checkbox"/>
Device type	e. g. 0 = standard device, with internal supply, for three-phase loads <input type="checkbox"/>
Size, rated operational current and power	e. g. 5 = 200 A (90 kW) for size S6 <input type="checkbox"/>
Version of the automatic RESET, electrical remote RESET	e. g. 6 = switchable between manual/auto RESET <input type="checkbox"/>
Trip class (CLASS)	e. g. 1 = CLASS 10E <input type="checkbox"/>
Setting range of the overload release	e.g. F = 5 ... 200 A <input type="checkbox"/>
Connection methods	e.g. C = busbar connections main circuit; screw terminals auxiliary circuit <input type="checkbox"/>
Installation type	e. g. 2 = mounting on contactor and stand-alone installation <input type="checkbox"/>
Example	3RB2 0 5 6 - 1 F C 2

Note:

The Article No. scheme shows an overview of product versions for better understanding of the logic behind the article numbers.

For your orders please use the article numbers quoted in the selection and ordering data.

Benefits

The most important features and benefits of the 3RB20/3RB21 electronic overload relays are listed in the overview table (see "General Data", page 7/71 onwards)

Application

Industries

The 3RB20 and 3RB21 electronic overload relays are suitable for customers from all industries who want to guarantee optimum inverse-time delayed protection of their electrical loads (e.g. motors) under normal and heavy starting conditions (CLASS 5E to 30E), minimize project completion times, inventories and energy consumption, and optimize plant availability and maintenance management.

Application

The 3RB20 and 3RB21 electronic overload relays have been designed for the protection of three-phase motors in sinusoidal 50/60 Hz voltage networks. The relays are not suitable for the protection of single-phase AC or DC loads.

The 3RU21 thermal overload relays or the 3RB22 to 3RB24 electronic overload relays can be used for single-phase AC loads. For DC loads we recommend the 3RU21 thermal overload relay.

Ambient conditions

The devices are insensitive to external influences such as shocks, corrosive ambient conditions, ageing and temperature fluctuations.

For the temperature range from -25 °C to +60 °C, the 3RB20 and 3RB21 electronic overload relays compensate the temperature in accordance with IEC 60947-4-1.

For the 3RB20 and 3RB21 electronic overload relays with the sizes S6, S10 and S12, the upper set value of the setting range must be reduced for ambient temperatures > 50 °C by a certain factor.

Use of SIRIUS protection devices in conjunction with IE3/IE4 motors

Note:

For the use of 3RB20 and 3RB21 electronic overload relays in conjunction with highly energy-efficient IE3/IE4 motors, please observe the information on dimensioning and configuring, see [Application Manual](#).

For more information, see [Preface on page 7](#).

Overload Relays

SIRIUS 3RB2 Electronic Overload Relays

3RB20, 3RB21 for standard applications

Technical specifications

More information

Configuration Manual "Configuring SIRIUS Innovations – Selection Data for Fuseless and Fused Load Feeders", see <https://support.industry.siemens.com/cs/ww/en/view/39714188>

Manual "SIRIUS – SIRIUS 3RU Thermal Overload Relays / SIRIUS 3RB Electronic Overload Relays", see <https://support.industry.siemens.com/cs/ww/en/view/60298164>

Technical specifications, see <https://support.industry.siemens.com/cs/ww/en/ps/16278>

The following technical information is intended to provide an initial overview of the various types of device and functions.

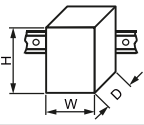
Type		3RB2056, 3RB2153	3RB2066, 3RB2163
Size		S6	S10/S12
Dimensions (W x H x D) (overload relay with stand-alone installation support)	 mm	120 x 119 x 155	145 x 147 x 156
General data			
Tripping in the event of		Overload, phase failure and phase asymmetry + ground fault (for 3RB21 only)	
Trip class acc. to IEC 60947-4-1	CLASS	3RB20: 10E or 20E; 3RB21: 5E, 10E, 20E and 30E adjustable	
Phase failure sensitivity		Yes	
Overload warning		No	
Reset and recovery		3RB20: Manual and automatic RESET; 3RB21: Manual, Automatic and Remote RESET	
• Reset options after tripping		Approx. 3 min Immediately Immediately	
• Recovery time			
- For automatic RESET			
- For manual RESET			
- For remote RESET			
Features		Yes, by means of switch position indicator slide	
• Display of operating state on device		Yes, test of electronics by pressing the TEST button/ test of auxiliary contacts and wiring of control circuit by actuating the switch position indicator slide/ self-monitoring	
• TEST function		Yes	
• RESET button		No	
• STOP button			
Protection and operation of explosion-proof motors		PTB 06 ATEX 3001 ⚠ II (2) G [Ex e] [Ex d] [Ex px] ⚠ II (2) G [Ex t] [Ex p] see https://support.industry.siemens.com/cs/ww/en/view/23814648	
EC type-examination certificate number according to directive 2014/34/EU (ATEX)			
Ambient temperatures			
• Storage/transport	°C	-40 ... +80	
• Operation	°C	-25 ... +60	
• Temperature compensation	°C	+60	
• Permissible rated current at			
- Temperature inside control cabinet 60 °C, stand-alone installation	%	100	100 or 90 ¹⁾
- Temperature inside control cabinet 60 °C, mounted on contactor	%	70	70
- Temperature inside control cabinet 70 °C	%	On request	
Degree of protection acc. to IEC 60529			
• Screw terminals/busbar connections		- IP20 (front side) - Terminal IP00 (use additional terminal covers for higher degree of protection)	
• Straight-through transformers		IP20	--

¹⁾ 90 % for relay with current setting range 160 A to 630 A.

Overload Relays

SIRIUS 3RB2 Electronic Overload Relays

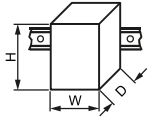

3RB20, 3RB21 for standard applications

Type		3RB2056, 3RB2153	3RB2066, 3RB2163
Size		S6	S10/S12
Dimensions (W x H x D) (overload relay with stand-alone installation support)	 mm	120 x 119 x 155	145 x 147 x 156
General data (continued)			
Touch protection acc. to IEC 60529		Finger-safe with terminal covers for vertical contact from the front	Finger-safe
• Screw terminals/busbar connections		Finger-safe	--
• Straight-through transformers			
Shock resistance with sine acc. to IEC 60068-2-27	g/ms	15/11 (signaling contact 97/98 in position "tripped": 4 g/ 11 ms)	
Electromagnetic compatibility (EMC) – Interference immunity			
• Conductor-related interference			
- Burst acc. to IEC 61000-4-4 (corresponds to degree of severity 3)	kV	2 (power ports), 1 (signal port)	
- Surge acc. to IEC 61000-4-5 (corresponds to degree of severity 3)	kV	2 (line to earth), 1 (line to line)	
• Electrostatic discharge according to IEC 61000-4-2 (corresponds to degree of severity 3)	kV	8 (air discharge), 6 (contact discharge)	
• Field-related interference acc. to IEC 61000-4-3 (corresponds to degree of severity 3)	V/m	10	
Electromagnetic compatibility (EMC) – Emitted interference		Degree of severity B acc. to EN 55011 (CISPR 11) and EN 55022 (CISPR 22)	
Resistance to extreme climates – air humidity	%	100	
Installation altitude above sea level	m	Up to 2 000	
Mounting position		Any	
Type of mounting		Direct mounting/stand-alone installation	

Overload Relays

SIRIUS 3RB2 Electronic Overload Relays

3RB20, 3RB21 for standard applications

Type		3RB2056, 3RB2153	3RB2066, 3RB2163
Size		S6	S10/S12
Main circuit			
Rated insulation voltage U_i (pollution degree 3)	V	1 000	
Rated impulse withstand voltage U_{imp}	kV	8	
Rated operational voltage U_e	V	1 000	
Type of current			
• Direct current		No	
• Alternating current		Yes, 50/60 Hz \pm 5 %	
Current setting	A	50 ... 200	55 ... 250, 160 ... 630
Power loss per unit (max.)	W	0.05	
Short-circuit protection		See "Selection and ordering data", pages 7/109 ... 7/111 "Short-Circuit Protection with Fuses/Motor Starter Protectors for Motor Feeders" see Configuration Manual.	
Protective separation between main and auxiliary current paths acc. to IEC 60947-1 (pollution degree 2)			
• For systems with grounded neutral point	V	690	
• For systems with ungrounded neutral point	V	600	
Conductor cross-sections of the main circuit			
Connection type		 Screw terminals with box terminal	
Terminal screw	mm	4 mm Allen screw	5 mm Allen screw
Operating devices	mm	4 mm Allen screw	5 mm Allen screw
Prescribed tightening torque	Nm	1 ... 12	20 ... 22
Conductor cross-sections (min./max.), 1 or 2 conductors can be connected			
• Solid	mm ²	--	--
• Finely stranded without end sleeve	mm ²	With 3RT1955-4G box terminal: 2 x (1 x max. 50, 1 x max. 70), 1 x (10 ... 70); With 3RT1956-4G box terminal: 2 x (1 x max. 95, 1 x max. 120), 1 x (10 ... 120)	2 x (50 ... 185), Front clamping point only: 1 x (70 ... 240); Rear clamping point only: 1 x (120 ... 185)
• Finely stranded with end sleeve (DIN 46228-1)	mm ²	With 3RT1955-4G box terminal: 2 x (1 x max. 50, 1 x max. 70), 1 x (10 ... 70); With 3RT1956-4G box terminal: 2 x (1 x max. 95, 1 x max. 120), 1 x (10 ... 120)	2 x (50 ... 185), Front clamping point only: 1 x (70 ... 240); Rear clamping point only: 1 x (120 ... 185)
• Stranded	mm ²	With 3RT1955-4G box terminal: 2 x (max. 70), 1 x (16 ... 70); With 3RT1956-4G box terminal: 2 x (max. 120), 1 x (16 ... 120)	2 x (70 ... 240), Front clamping point only: 1 x (95 ... 300); Rear clamping point only: 1 x (120 ... 240)
• AWG cables, solid or stranded	AWG	With 3RT1955-4G box terminal: 2 x (max. 1/0), 1 x (6 ... 2/0); With 3RT1956-4G box terminal: 2 x (max. 3/0), 1 x (6 ... 250 kcmil)	2 x (2/0 ... 500 kcmil), Front clamping point only: 1 x (3/0 ... 600 kcmil); Rear clamping point only: 1 x (250 kcmil ... 500 kcmil)
• Ribbon cables (Number x Width x Thickness)	mm	With 3RT1955-4G box terminal: 2 x (6 x 15.5 x 0.8), 1 x (3 x 9 x 0.8 ... 6 x 15.5 x 0.8); With 3RT1956-4G box terminal: 2 x (10 x 15.5 x 0.8), 1 x (3 x 9 x 0.8 ... 10 x 15.5 x 0.8)	2 x (20 x 24 x 0.5), 1 x (6 x 9 x 0.8 ... 20 x 24 x 0.5)
Connection type		 Busbar connections	
Terminal screw		M8 x 25	M10 x 30
Prescribed tightening torque	Nm	10 ... 14	14 ... 24
Conductor cross-sections (min./max.)			
• Finely stranded with cable lug	mm ²	16 ... 95 ¹⁾	50 ... 240 ²⁾
• Stranded with cable lug	mm ²	25 ... 120 ¹⁾	70 ... 240 ²⁾
• AWG cables, solid or stranded, with cable lug	AWG	4 ... 250 kcmil	2/0 ... 500 kcmil
• With connecting bars (max. width)	mm	15	25
Connection type		 Straight-through transformers	
Diameter of opening	mm	24.5	--



¹⁾ When connecting cable lugs according to DIN 46235 with conductor cross-sections of 95 mm² and more, the 3RT1956-4EA1 terminal cover must be used to ensure phase clearance, see page 7/112.

²⁾ When connecting cable lugs according to DIN 46234 for conductor cross-sections from 240 mm², as well as DIN 46235 for cable cross-sections from 185 mm², the 3RT1956-4EA1 terminal cover must be used to ensure phase clearance, see page 7/112.

Overload Relays

SIRIUS 3RB2 Electronic Overload Relays

3RB20, 3RB21 for standard applications

Type	3RB2056, 3RB2153		3RB2066, 3RB2163	
Size	S6		S10/S12	
Auxiliary circuit				
Number of NO contacts	1			
Number of NC contacts	1			
Auxiliary contacts – assignment	1 NO for the signal "tripped"; 1 NC for disconnecting the contactor			
Rated insulation voltage U_i (pollution degree 3)	V	300		
Rated impulse withstand voltage U_{imp}	kV	4		
Auxiliary contacts – contact rating				
• NC contact with alternating current AC-14/AC-15, rated operational current I_e at U_e :				
- 24 V	A	4		
- 120 V	A	4		
- 125 V	A	4		
- 250 V	A	3		
• NO contact with alternating current AC-14/AC-15, rated operational current I_e at U_e :				
- 24 V	A	4		
- 120 V	A	4		
- 125 V	A	4		
- 250 V	A	3		
• NC, NO contacts with DC current DC-13, rated operational current I_e at U_e :				
- 24 V	A	2		
- 60 V	A	0.55		
- 110 V	A	0.3		
- 125 V	A	0.3		
- 250 V	A	0.11		
• Conventional thermal current I_{th}	A	5		
• Contact reliability (suitability for PLC control; 17 V, 5 mA)		Yes		
Short-circuit protection				
• With fuse, operational class gG	A	6		
Ground-fault protection (only 3RB21)				
• Tripping value I_{Δ}		The information refers to sinusoidal residual currents at 50/60 Hz. > $0.75 \times I_{motor}$		
• Operating range I		Lower current setting < I_{motor} < $3.5 \times$ upper current setting		
• Response time t_{trip} (in steady-state condition)	s	< 1		
Integrated electrical remote RESET (only 3RB21)				
Connecting terminals A3, A4		24 V DC, 100 mA, 2.4 W short-term		
Protective separation between auxiliary current paths acc. to IEC 60947-1	V	300		
CSA, UL, UR rated data				
Auxiliary circuit – switching capacity		B300, R300		
Conductor cross-sections of the auxiliary circuit				
Connection type		 Screw terminals		
Terminal screw		M3, Pozidriv size 2		
Operating devices	mm	∅ 5 ... 6		
Prescribed tightening torque	Nm	0.8 ... 1.2		
Conductor cross-sections (min./max.), 1 or 2 conductors can be connected				
• Solid and stranded	mm ²	1 × (0.5 ... 4) ¹⁾ , 2 × (0.5 ... 2.5) ¹⁾		
• Finely stranded without end sleeve	mm ²	--		
• Finely stranded with end sleeve (DIN 46228-1)	mm ²	1 × (0.5 ... 2.5) ¹⁾ , 2 × (0.5 ... 1.5) ¹⁾		
• AWG cables, solid or stranded	AWG	2 × (20 ... 14)		
Connection type		 Spring-type terminals		
Operating devices	mm	3.0 x 0.5		
Conductor cross-sections (min./max.), 1 or 2 conductors can be connected				
• Solid and stranded	mm ²	2 × (0.25 ... 1.5)		
• Finely stranded without end sleeve	mm ²	--		
• Finely stranded with end sleeve (DIN 46228-1)	mm ²	2 × (0.25 ... 1.5)		
• AWG cables, solid or stranded	AWG	2 × (24 ... 16)		

¹⁾ If two different conductor cross-sections are connected to one clamping point, both cross-sections must be in the range specified.

Overload Relays

SIRIUS 3RB2 Electronic Overload Relays

IE3/IE4 ready 3RB20, 3RB21 for standard applications

Selection and ordering data

3RB20 electronic overload relays for mounting onto contactors and stand-alone installation, CLASS 10E

Features and technical specifications:

- Connection methods
 - Size S6
Main circuit: With busbar connection or as straight-through transformer,
Auxiliary circuit: Either screw or spring-type terminals
 - Sizes S10/S12:
Main circuit: With busbar connection,
Auxiliary circuit: Either screw or spring-type terminals
- Overload protection, phase failure protection and asymmetry protection
- Internal power supply
- Auxiliary contacts 1 NO + 1 NC
- Manual and automatic RESET
- Switch position indicator
- TEST function and self-monitoring

 PU (UNIT, SET, M) = 1
 PS* = 1 unit
 PG = 41G

3RB2056-1FW2

3RB2066-1MF2

Size contactor	Rated power for three-phase motors, rated value ¹⁾	Current setting value of the inverse-time delayed overload release	Short-circuit protection with fuse, type of coordination "2", operational class gG ²⁾	SD	Screw terminals (on auxiliary current side)	SD	Spring-type terminals (on auxiliary current side)	
kW	A	A	d	Article No.	Price per PU	d	Article No.	Price per PU

Size S6

Devices with busbar connection for mounting onto contactor and stand-alone installation

S6	22 ... 90	50 ... 200	315	▶	3RB2056-1FC2	2	3RB2056-1FF2
----	-----------	------------	-----	---	---------------------	---	---------------------

Devices with straight-through transformer for mounting onto contactor and stand-alone installation

For mounting onto S6 contactors with box terminals	22 ... 90	50 ... 200	315	▶	3RB2056-1FW2	▶	3RB2056-1FX2
--	-----------	------------	-----	---	---------------------	---	---------------------

Size S10/S12

Devices with busbar connection for mounting onto contactor and stand-alone installation

S10/S12	22 ... 110	55 ... 250	400	▶	3RB2066-1GC2	▶	3RB2066-1GF2
and size 14 (3TF68/3TF69) ³⁾	90 ... 450	160 ... 630	800	▶	3RB2066-1MC2	▶	3RB2066-1MF2

¹⁾ Guide value for 4-pole standard motors at 50 Hz 400 V AC. The actual starting and rated data of the motor to be protected must be considered when selecting the units.

²⁾ Maximum protection by fuse only for overload relays, type of coordination "2". For fuse values in connection with contactors, see [Configuration Manual](#).

³⁾ For 3TF68/3TF69 contactors, direct mounting is not possible.

Overload Relays

SIRIUS 3RB2 Electronic Overload Relays

3RB20, 3RB21 for standard applications **IE3/IE4 ready**

3RB20 electronic overload relays for mounting onto contactors and stand-alone installation, CLASS 20E

Features and technical specifications:

- Connection methods
 - Size S6
Main circuit: With busbar connection or as straight-through transformer,
Auxiliary circuit: Either screw or spring-type terminals
 - Sizes S10/S12:
Main circuit: With busbar connection,
Auxiliary circuit: Either screw or spring-type terminals
 - Overload protection, phase failure protection and asymmetry protection
 - Internal power supply
 - Auxiliary contacts 1 NO + 1 NC
 - Manual and automatic RESET
 - Switch position indicator
 - TEST function and self-monitoring
- PU (UNIT, SET, M) = 1
 PS* = 1 unit
 PG = 41G



3RB2056-1FW2



3RB2066-1MF2

Size contactor	Rated power for three-phase motors, rated value ¹⁾	Current setting value of the inverse-time delayed overload release	Short-circuit protection with fuse, type of coordination "2", operational class gG ²⁾	SD	Screw terminals (on auxiliary current side)	SD	Spring-type terminals (on auxiliary current side)	
	kW	A	A	d	Article No.	Price per PU	Article No.	Price per PU

Size S6

Devices with busbar connection for mounting onto contactor and stand-alone installation

S6	22 ... 90	50 ... 200	315	▶	3RB2056-2FC2	2	3RB2056-2FF2
----	-----------	------------	-----	---	---------------------	---	---------------------

Devices with straight-through transformer for mounting onto contactor and stand-alone installation

For mounting onto S6 contactors with box terminals	22 ... 90	50 ... 200	315	▶	3RB2056-2FW2	▶	3RB2056-2FX2
--	-----------	------------	-----	---	---------------------	---	---------------------

Size S10/S12²⁾

Devices with busbar connection for mounting onto contactor and stand-alone installation

S10/S12	22 ... 110	55 ... 250	400	▶	3RB2066-2GC2	▶	3RB2066-2GF2
and size 14 (3TF68/ 3TF69) ³⁾	90 ... 450	160 ... 630	800	▶	3RB2066-2MC2	▶	3RB2066-2MF2

1) Guide value for 4-pole standard motors at 50 Hz 400 V AC. The actual starting and rated data of the motor to be protected must be considered when selecting the units.
 2) Maximum protection by fuse only for overload relays, type of coordination "2". For fuse values in connection with contactors, see Configuration Manual.
 3) For 3TF68/3TF69 contactors, direct mounting is not possible.

Overload Relays

SIRIUS 3RB2 Electronic Overload Relays

IE3/IE4 ready 3RB20, 3RB21 for standard applications

3RB21 electronic overload relays for mounting onto contactors and stand-alone installation, CLASS 5E, 10E, 20E and 30E adjustable

Features and technical specifications:

- Connection methods
 - Size S6
Main circuit: With busbar connection or as straight-through transformer,
Auxiliary circuit: Either screw or spring-type terminals
 - Sizes S10/S12:
Main circuit: With busbar connection,
Auxiliary circuit: Either screw or spring-type terminals
 - Overload protection, phase failure protection and asymmetry protection
 - Internal ground-fault detection (activatable)
 - Internal power supply
 - Auxiliary contacts 1 NO + 1 NC
 - Manual and automatic RESET
 - Electrical remote RESET integrated
 - Switch position indicator
 - TEST function and self-monitoring
- PU (UNIT, SET, M) = 1
 PS* = 1 unit
 PG = 41G



3RB2153-4FX2

3RB2163-4MC2

Size contactor	Rated power for three-phase motors, rated value ¹⁾	Current setting value of the inverse-time delayed overload release	Short-circuit protection with fuse, type of coordination "2", operational class gG ²⁾	SD	Screw terminals (on auxiliary current side)	SD	Spring-type terminals (on auxiliary current side)	
	kW	A	A	d	Article No.	Price per PU _d	Article No.	Price per PU
Size S6								
Devices with busbar connection for mounting onto contactor and stand-alone installation								
S6	22 ... 90	50 ... 200	315	▶	3RB2153-4FC2	▶	3RB2153-4FF2	
Devices with straight-through transformer for mounting onto contactor and stand-alone installation								
For mounting onto S6 contactors with box terminals	22 ... 90			▶	3RB2153-4FW2	▶	3RB2153-4FX2	
Size S10/S12²⁾								
Devices with busbar connection for mounting onto contactor and stand-alone installation								
S10/S12	22 ... 110	55 ... 250	400	▶	3RB2163-4GC2	▶	3RB2163-4GF2	
and size 14 (3TF68/3TF69) ³⁾	90 ... 450	160 ... 630	800	▶	3RB2163-4MC2	▶	3RB2163-4MF2	

¹⁾ Guide value for 4-pole standard motors at 50 Hz 400 V AC. The actual starting and rated data of the motor to be protected must be considered when selecting the units.

²⁾ Maximum protection by fuse only for overload relays, type of coordination "2". For fuse values in connection with contactors, see [Configuration Manual](#).

³⁾ For 3TF68/3TF69 contactors, direct mounting is not possible.

Overload Relays

SIRIUS 3RB2 Electronic Overload Relays

Accessories for 3RB20, 3RB21







Overview

Overload relays for standard applications

The following optional accessories are available for the 3RB20 and 3RB21 electronic overload relays:

- Mechanical RESET (for all sizes)
- Cable release for resetting devices which are difficult to access (for all sizes)
- Sealable cover (for all sizes)
- Terminal covers for sizes S6 to S10/S12
- Box terminal blocks for sizes S6 and S10/S12

Selection and ordering data

Version	Size	SD	Article No.	Price per PU	PU (UNIT, SET, M)	PS*	PG			
Mechanical RESET										
 <p>3RU1900-1A with pushbutton and extension plunger</p>	Resetting plungers, holders and formers		S6 S10/S12 ▶	3RU1900-1A	1	1 unit	41F			
	Pushbuttons with extended stroke (12 mm), IP65, ∅ 22 mm		S6 S10/S12 ▶	3SU1200-0FB10-0AA0	1	1 unit	41J			
	Extension plungers For compensation of the distance between a pushbutton and the unlatching button of the relay		S6 S10/S12 ▶	3SU1900-0KG10-0AA0	1	1 unit	41J			
Cable releases with holder for RESET										
 <p>3RU1900-1.</p>	For ∅ 6.5 mm holes in the control panel; max. control panel thickness 8 mm		S6 S10/S12	▶						
	<ul style="list-style-type: none"> • Length 400 mm • Length 600 mm 							3RU1900-1B	1	1 unit
							3RU1900-1C	1	1 unit	41F
Sealable covers										
 <p>3RB2984-0</p>	For covering the setting knobs		S6 S10/S12 ▶	3RB2984-0	1	10 units	41F			
Terminal covers										
 <p>3RT1956-4EA1</p>  <p>3RT1956-4EA2</p>	Covers for cable lugs and busbar connections									
	• Length 100 mm		S6 ▶	3RT1956-4EA1	1	1 unit	41B			
	• Length 120 mm		S10/S12 ▶	3RT1966-4EA1	1	1 unit	41B			
	Covers for box terminals									
	• Length 25 mm		S6 ▶	3RT1956-4EA2	1	1 unit	41B			
	• Length 30 mm		S10/S12 ▶	3RT1966-4EA2	1	1 unit	41B			
Covers for screw terminals between contactor and overload relay, without box terminals (1 unit required per combination)		S6 ▶	3RT1956-4EA3	1	1 unit	41B				
		S10/S12 ▶	3RT1966-4EA3	1	1 unit	41B				
Box terminal blocks										
 <p>3RT195.-4G</p>	For round and ribbon cables									
	• Up to 70 mm ²		S6 ¹⁾ ▶	3RT1955-4G	1	1 unit	41B			
	• Up to 120 mm ²		S6 ▶	3RT1956-4G	1	1 unit	41B			
	• Up to 240 mm ²		S10/S12 ▶	3RT1966-4G	1	1 unit	41B			



¹⁾ In the scope of supply for 3RT1054-1 contactors (55 kW).

Overload Relays

SIRIUS 3RB2 Electronic Overload Relays

Accessories for 3RB20, 3RB21

General accessories

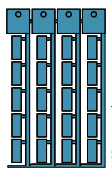
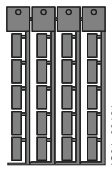
Version	Size	Color	For overload relays	SD	Article No.	Price per PU	PU (UNIT, SET, M)	PS*	PG
Tools for opening spring-type terminals									
 3RA2908-1A	Screwdrivers For all SIRIUS devices with spring-type terminals	Length approx. 200 mm, 3.0 mm x 0.5 mm	Titanium gray/black, partially insulated	Main and auxiliary circuit connection: 3RB2	2	Spring-type terminals 	1	1 unit	41B
						3RA2908-1A			
Blank labels									
 3RT1900-1SB20	Unit labeling plates¹⁾ For SIRIUS devices	20 mm x 7 mm	Pastel turquoise	3RB2	20	3RT1900-1SB20	100	340 units	41B
		20 mm x 7 mm	Titanium gray	3RB2	20	3RT2900-1SB20	100	340 units	41B
	Adhesive inscription labels¹⁾ For SIRIUS devices	19 mm x 6 mm	Pastel turquoise	3RU2	15	3RT1900-1SB60	100	3 060 units	41B
		19 mm x 6 mm	Zinc yellow	3RU2	15	3RT1900-1SD60	100	3 060 units	41B
 3RT2900-1SB20									

¹⁾ PC labeling system for individual inscription of unit labeling plates available from: murrplastik Systemtechnik GmbH (see page 16/20).

Overload Relays

SIRIUS 3RB2 Electronic Overload Relays

3RB22, 3RB23 for high-feature applications

Overview

More information

Home page, see <http://www.siemens.com/sirius-overloadrelays>
Industry Mall, see www.siemens.com/product?3RB2

Application Manual "SIRIUS Controls with IE3/IE4 Motors", see <https://support.industry.siemens.com/cs/ww/en/view/94770820>
Operating Instructions "3RB22, 3RB23 Electronic Overload Relays", see <https://support.industry.siemens.com/cs/ww/en/view/21833251>
Characteristics and certificates, see <https://support.industry.siemens.com/cs/ww/en/ps/16280>

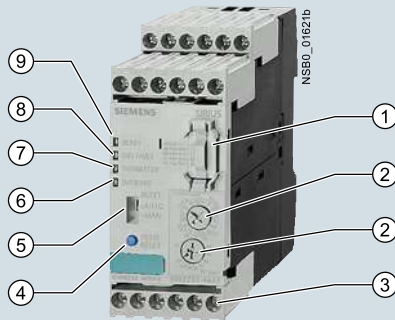

- ① 3RB2985 function expansion module:
Enables more functions to be added, e.g. internal ground-fault detection and/or an analog output with corresponding signals.
- ② Motor current and trip class setting:
Setting the device to the motor current and to the required trip class dependent on the start-up conditions is easy with the two rotary switches.
- ③ Connecting terminals (removable joint block):
The generously sized terminals permit connection of two conductors with different cross-sections for the auxiliary, control and sensor circuits. Connection is possible with screw connection and alternatively with spring-type connection.
- ④ Test/RESET button:
Enables testing of all important device components and functions, plus resetting of the device after a trip when manual RESET is selected.
- ⑤ Selector switch for manual/automatic RESET:
With this switch you can choose between manual and automatic RESET.
- ⑥ Red LED "OVERLOAD":
A continuous red light signals an active overload trip; a flickering red light signals an imminent trip (overload warning).
- ⑦ Red LED "THERMISTOR":
A continuous red light signals an active thermistor trip.
- ⑧ Red LED "GND FAULT":
A continuous red light signals a ground-fault tripping.
- ⑨ Green LED "READY":
A continuous green light signals that the device is working correctly.

SIRIUS 3RB22 and 3RB23 evaluation modules

The 3RB22 and 3RB23 electronic overload relays up to 630 A (up to 820 A possible in combination with a series transformer) are from a modular system and comprise an evaluation unit, a current measuring module and a connecting cable. The 3RB22 overload relays (with monostable auxiliary contacts) and the 3RB23 overload relays (with bistable auxiliary contacts) are supplied from an external voltage.

They have been designed for inverse-time delayed protection of loads with normal and heavy starting against excessive temperature rises due to overload, phase asymmetry or phase failure. An overload, phase asymmetry or phase failure result in an increase of the motor current beyond the set rated motor current.

This current rise is detected by means of a current measuring module (see page 7/132) and electronically evaluated by the evaluation module which is connected to it. The evaluation electronics sends a signal to the auxiliary contacts. The auxiliary contacts then switch off the load by means of a contactor.

The break time depends on the ratio between the tripping current and current setting I_e and is stored in the form of a long-term stable tripping characteristic curve (see [Characteristic Curves](#)). The "tripped" status is signaled by means of a continuously illuminated red "OVERLOAD" LED.

The LED indicates imminent tripping of the relay due to overload, phase asymmetry or phase failure by flickering when the limit current has been violated. In the case of the 3RB22 and 3RB23 overload relays this warning can also be issued through auxiliary contacts.

In addition to the described inverse-time delayed protection of loads against excessive temperature rises, the 3RB22 and 3RB23 electronic overload relays also allow direct temperature monitoring of the motor windings (full motor protection) by connection with broken-wire interlock of a PTC sensor circuit. With this temperature-dependent protection, the loads can be protected against overheating caused, for example, indirectly by reduced coolant flow and which cannot be detected by means of the current alone. In the event of overheating, the devices switch off the contactor, and thus the load, by means of the auxiliary contacts. The "tripped" status is signaled by means of a continuously illuminated "THERMISTOR" LED.

To protect the loads against high-resistance short circuits due to damage to the insulation, humidity, condensed water, etc., the 3RB22 and 3RB23 electronic overload relays offer the possibility of internal ground fault monitoring in conjunction with a function expansion module (for details, see [Operating Instructions](#), not possible in conjunction with contactor assemblies for start-delta (wye-delta) starting). In the event of a ground fault the 3RB22 and 3RB23 relays trip instantaneously.

The "tripped" status is signaled by means of a continuous red "Ground Fault" LED. Signaling through auxiliary contacts is also possible.

After tripping due to overload, phase asymmetry, phase failure, thermistor or ground-fault tripping, the relay is reset manually or automatically after the recovery time has elapsed.

In conjunction with a function expansion module, the motor current measured by the microprocessor can be output in the form of a DC 4 mA to 20 mA analog signal for operating rotary coil instruments or for feeding into analog inputs of programmable logic controllers.

Overload Relays

SIRIUS 3RB2 Electronic Overload Relays

3RB22, 3RB23 for high-feature applications

With an additional AS-Interface analog module the current values can also be transferred over the AS-i bus system.

The 3RB2 electronic overload relays are suitable for operation with frequency converters.

The devices are manufactured in accordance with environmental guidelines and contain environmentally friendly and reusable materials. They comply with all important worldwide standards and approvals.

Article No. scheme

Product versions	Article number
Electronic overload relays	3RB2 <input type="checkbox"/> <input type="checkbox"/> <input type="checkbox"/> - <input type="checkbox"/> <input type="checkbox"/> <input type="checkbox"/>
Device type	e. g. 2 = monostable device for high-feature applications, supplied from external source, for three-phase loads <input type="checkbox"/>
Size, rated operational current and power	e. g. 8 = irrespective of size and current <input type="checkbox"/>
Version of the automatic RESET, electrical remote RESET	e. g. 3 = switchable between manual/auto RESET, with integral electrical remote RESET <input type="checkbox"/>
Trip class (CLASS)	e. g. 4 = CLASS 5E, 10E, 20E, 30E (adjustable) <input type="checkbox"/>
Setting range of the overload release	e.g. A = none specified <input type="checkbox"/>
Connection methods	e.g. A = screw terminals for auxiliary, control and main circuits <input type="checkbox"/>
Installation type	e. g. 1 = stand-alone installation <input type="checkbox"/>
Example	3RB2 2 8 3 - 4 A A 1

Note:

The Article No. scheme shows an overview of product versions for better understanding of the logic behind the article numbers.

Use in hazardous areas

The 3RB22 electronic overload relays (monostable) with the 3RB29 current measuring module are suitable for the overload protection of explosion-proof motors.

EC type test certificate for category (2) G/D exists. It has the number PTB 05 ATEX 3022.

For your orders please use the article numbers quoted in the selection and ordering data.

Benefits

The most important features and benefits of the 3RB22 and 3RB23 electronic overload relays are listed in the overview table, (see "General Data", page 7/71 onwards).

Advantages through energy efficiency

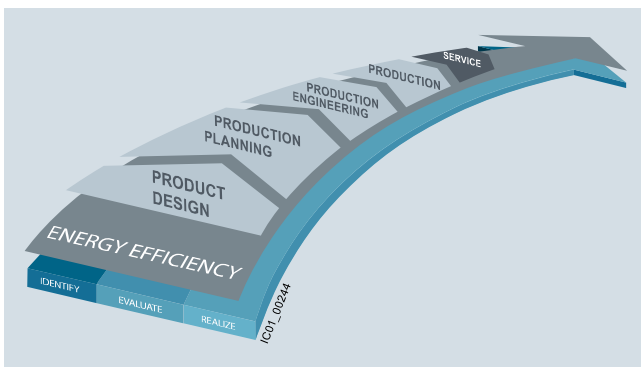

Overview of the energy management process

We offer you a unique portfolio for industrial energy management, using an energy management system that helps to optimally define your energy needs. We split up our industrial energy management into three phases – identify, evaluate, and realize – and we support you with the appropriate hardware and software solutions in every process phase.

The innovative products of the SIRIUS industrial controls portfolio can also make a substantial contribution to a plant's energy efficiency, see www.siemens.com/sirius/energysaving.

3RB22 and 3RB23 electronic overload relays contribute to energy efficiency throughout the plant as follows:

- Reduced inherent power loss
- Less heating of the control cabinet
- Smaller control cabinet air conditioners can be used

Application

Industries

The 3RB22/3RB23 electronic overload relays are suitable for customers from all industries who want to guarantee optimum inverse-time delayed and temperature-dependent protection of their electrical loads (e. g. motors) under normal and heavy starting conditions (CLASS 5 to CLASS 30), minimize project completion times, inventories and power consumption, and optimize plant availability and maintenance management.

Application

The 3RB22 and 3RB23 devices have been designed for the protection of three-phase asynchronous and single-phase AC motors.

If single-phase AC motors are to be protected by the 3RB22 and 3RB23 electronic overload relays, the main current paths of the current measuring modules must be series-connected. For circuit diagrams see [Operating Instructions](#).

Ambient conditions

The devices are insensitive to external influences such as shocks, corrosive ambient conditions, ageing and temperature fluctuations.

For the temperature range from -25 °C to +60 °C, the 3RB22 and 3RB23 electronic overload relays compensate the temperature in accordance with IEC 60947-4-1.

Configuration notes for use of the devices below -25°C or above +60°C on request.

Use of SIRIUS protection devices in conjunction with IE3/IE4 motors

Note:

For the use of 3RB22 and 3RB23 electronic overload relays in conjunction with highly energy-efficient IE3/IE4 motors, please observe the information on dimensioning and configuring, see [Application Manual](#).

For more information, see [Preface on page 7](#).

Overload Relays

SIRIUS 3RB2 Electronic Overload Relays

3RB22, 3RB23 for high-feature applications

Technical specifications

More information



Application Manual "SIRIUS Controls with IE3/IE4 Motors", see <https://support.industry.siemens.com/cs/ww/en/view/94770820>

Configuration Manual "Configuring SIRIUS Innovations – Selection Data for Fuseless and Fused Load Feeders", see <https://support.industry.siemens.com/cs/ww/en/view/39714188>

Operating Instructions "3RB22, 3RB23 Electronic Overload Relays", see <https://support.industry.siemens.com/cs/ww/en/view/21833251>

Technical specifications, see <https://support.industry.siemens.com/cs/ww/en/ps/16280/td>

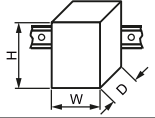
The following technical information is intended to provide an initial overview of the various types of device and functions.

Type – Overload relay: evaluation modules		3RB2283-4A.1	3RB2383-4A.1
Size contactor		S00 ... S10/S12	
Dimensions of evaluation modules (W x H x D)		mm	45 x 111 x 95
General data			
Tripping in the event of		Overload, phase failure and phase asymmetry (> 40 % according to NEMA), + ground fault (with corresponding function expansion module) and activation of the thermistor motor protection (with closed PTC sensor circuit)	
Trip class acc. to IEC 60947-4-1	CLASS	5E, 10E, 20E and 30E adjustable	
Phase failure sensitivity		Yes	
Overload warning		Yes, from $1.125 \times I_b$ for symmetrical loads and from $0.85 \times I_e$ for unsymmetrical loads	
Reset and recovery		Manual, Automatic and Remote RESET	
• Reset options after tripping			
• Recovery time			
- For automatic RESET	min.	- For tripping due to overcurrent: 3 (stored permanently), - For tripping by thermistor: Time until the motor temperature has fallen 5 K below the response temperature, - For tripping due to a ground fault: no automatic RESET	
- For manual RESET	min.	- For tripping due to overcurrent: 3 (stored permanently), - For tripping by thermistor: Time until the motor temperature has fallen 5 K below the response temperature, - For tripping due to a ground fault: Immediately	
- For remote RESET	min.	- For tripping due to overcurrent: 3 (stored permanently), - For tripping by thermistor: Time until the motor temperature has fallen 5 K below the response temperature, - For tripping due to a ground fault: Immediately	
Features			
• Display of operating state on device		Yes, with four LEDs: - Green LED "Ready", - Red LED "Ground Fault", - Red LED "Thermistor", - Red LED "Overload"	
• TEST function		Yes, test of LEDs, electronics, auxiliary contacts and wiring of control circuit by pressing the button TEST/RESET / self-monitoring	
• RESET button		Yes, with the TEST/RESET button	
• STOP button		No	
Protection and operation of explosion-proof motors			
EC type-examination certificate number according to directive 2014/34/EU (ATEX)		PTB 05 ATEX 3022  II (2) GD see https://support.automation.siemens.com/WW/view/en/23115758	--
Ambient temperatures			
• Storage/transport	°C	-40 ... +80	
• Operation	°C	-25 ... +60	
• Temperature compensation	°C	+60	
• Permissible rated current			
- Temperature inside control cabinet 60 °C	%	100	
- Temperature inside control cabinet 70 °C	%	On request	
Degree of protection acc. to IEC 60529		IP20	
Touch protection acc. to IEC 60529		Finger-safe	
Shock resistance with sine acc. to IEC 60068-2-27	g/ms	15/11	

Overload Relays

SIRIUS 3RB2 Electronic Overload Relays

3RB22, 3RB23 for high-feature applications



Type – Overload relay: evaluation modules		3RB2283-4A.1	3RB2383-4A.1
Size contactor		S00 ... S10/S12	
Dimensions of evaluation modules (W x H x D)		45 x 111 x 95	
General data (continued)			
Electromagnetic compatibility (EMC) – Interference immunity			
• Conductor-related interference			
- Burst acc. to IEC 61000-4-4 (corresponds to degree of severity 3)	kV	2 (power ports), 1 (signal port)	
- Surge acc. to IEC 61000-4-5 (corresponds to degree of severity 3)	kV	2 (line to earth), 1 (line to line)	
• Electrostatic discharge according to IEC 61000-4-2 (corresponds to degree of severity 3)	kV	8 (air discharge), 6 (contact discharge)	
• Field-related interference acc. to IEC 61000-4-3 (corresponds to degree of severity 3)	V/m	10	
Electromagnetic compatibility (EMC) – Emitted interference		Degree of severity A according to EN 55011 (CISPR 11) and EN 55022 (CISPR 22)	
Resistance to extreme climates – air humidity	%	100	
Installation altitude above sea level	m	Up to 2 000	
Mounting position		Any	
Type of mounting			
• Evaluation modules		Stand-alone installation	
• Current measuring module	Size	S00 to S3: Stand-alone installation, S6 and S10/S12: Stand-alone installation or mounting onto contactors	
Type – Overload relay: evaluation modules			
Size contactor		3RB2283-4A.1, 3RB2383-4A.1	
		S00 ... S10/S12	
Auxiliary circuit			
Number of NO contacts		2	
Number of NC contacts		2	
Number of CO contacts		--	
Auxiliary contacts – assignment			
		<ul style="list-style-type: none"> • Alternative 1 <ul style="list-style-type: none"> - 1 NO for the signal "tripped by overload and/or thermistor", - 1 NC for disconnecting the contactor, - 1 NO for the signal "tripped by ground fault", - 1 NC for disconnecting the contactor or ¹⁾ • Alternative 2 <ul style="list-style-type: none"> - 1 NO for the signal "tripped by overload and/or thermistor and/or ground fault", - 1 NC for disconnecting the contactor, - 1 NO for overload warning - 1 NC for disconnecting the contactor 	
Rated insulation voltage U_i (pollution degree 3)	V	300	
Rated impulse withstand voltage U_{imp}	kV	4	
Auxiliary contacts – contact rating			
• NC, NO contact with alternating current AC-14/AC-15, rated operational current I_e at U_e			
- 24 V	A	6	
- 120 V	A	6	
- 125 V	A	6	
- 250 V	A	3	
• NC, NO contacts with DC current DC-13, rated operational current I_e at U_e			
- 24 V	A	2	
- 60 V	A	0.55	
- 110 V	A	0.3	
- 125 V	A	0.3	
- 250 V	A	0.2	
• Conventional thermal current I_{th}	A	5	
• Contact reliability (suitability for PLC control; 17 V, 5 mA)		Yes	
Short-circuit protection			
• With fuse, operational class gG	A	6	
• With miniature circuit breaker, C characteristic	A	1.6	
Protective separation between auxiliary current paths	V	300	
Acc. to IEC 60947-1			
CSA, UL, UR rated data			
Auxiliary circuit – switching capacity		B300, R300	

¹⁾ The assignment of auxiliary contacts may be influenced by function expansion modules.

Overload Relays

SIRIUS 3RB2 Electronic Overload Relays

3RB22, 3RB23 for high-feature applications

Type – Overload relay: evaluation modules	3RB2283-4A.1, 3RB2383-4A.1	
Size contactor	S00 ... S10/S12	
Control circuit		
Rated insulation voltage U_i (pollution degree 3)	V	300
Rated impulse withstand voltage U_{imp}	kV	4
Rated control supply voltage U_s		
• 50/60 Hz AC	V	24 ... 240
• DC	V	24 ... 240
Operating range		
• 50/60 Hz AC		$0.85 \times U_{s \min} \leq U_s \leq 1.1 \times U_{s \max}$
• DC		$0.85 \times U_{s \min} \leq U_s \leq 1.1 \times U_{s \max}$
Rated power		
• 50/60 Hz AC	W	0.5
• DC	W	0.5
Mains buffering time	ms	200
Sensor circuit		
Thermistor motor protection (PTC thermistor sensor)		
• Summation cold resistance	k Ω	≤ 1.5
• Response value	k Ω	3.4 ... 3.8
• Return value	k Ω	1.5 ... 1.65
Ground-fault detection	The information refers to sinusoidal residual currents at 50/60 Hz.	
• Tripping value $I_{\Delta}^{1)}$		
- For $0.3 \times I_e < I_{motor} < 2.0 \times I_e$		$> 0.3 \times I_e$
- For $2.0 \times I_e < I_{motor} < 8.0 \times I_e$		$> 0.15 \times I_{motor}$
• Response time t_{trip}	ms	500 ... 1 000
Analog output¹⁾²⁾		
Rated values		
• Output signal	mA	4 ... 20
• Measuring range		0 ... $1.25 \times I_e$ 4 mA is equivalent to $0 \times I_e$ 16.8 mA is equivalent to $1.0 \times I_e$ 20 mA is equivalent to $1.25 \times I_e$
• Load, max.	Ω	100
Conductor cross-sections for the auxiliary, control and sensor circuits as well as the analog output		
Connection type	 Screw terminals	
Terminal screw	M3, Pozidriv size 2	
Operating devices	mm	3.0 x 0.5
Prescribed tightening torque	Nm	0.8 ... 1.2
Conductor cross-sections (min./max.), 1 or 2 conductors can be connected		
• Solid or stranded	mm ²	$1 \times (0.5 \dots 4)^3, 2 \times (0.5 \dots 2.5)^3$
• Finely stranded without end sleeve	mm ²	--
• Finely stranded with end sleeve (DIN 46228-1)	mm ²	$1 \times (0.5 \dots 2.5)^3, 2 \times (0.5 \dots 1.5)^3$
• AWG cables, solid or stranded	AWG	$2 \times (20 \dots 14)$
Connection type	 Spring-type terminals	
Operating devices	mm	3.0 x 0.5
Conductor cross-sections (min./max.), 1 or 2 conductors can be connected		
• Solid or stranded	mm ²	$2 \times (0.25 \dots 1.5)$
• Finely stranded without end sleeve	mm ²	--
• Finely stranded with end sleeve (DIN 46228-1)	mm ²	$2 \times (0.25 \dots 1.5)$
• AWG cables, solid or stranded	AWG	$2 \times (24 \dots 16)$

1) For the 3RB22 and 3RB23 overload relays in combination with a corresponding function expansion module.

2) Analog input modules, e.g. SM 331, must be configured for 4-wire measuring transducers. In this case the analog input module must not supply current to the analog output of the 3RB22 and 3RB23 relay.

3) If two different conductor cross-sections are connected to one clamping point, both cross-sections must be in the range specified.

Overload Relays

SIRIUS 3RB2 Electronic Overload Relays

3RB22, 3RB23 for high-feature applications

Functions of the 3RB22 and 3RB23 evaluation modules in combination with the 3RB2985 function expansion modules

Evaluation modules	With function expansion module	Basic functions	Inputs		
			A1/A2	T1/T2	Y1/Y2
3RB2283-4AA1 3RB2283-4AC1 3RB2383-4AA1 3RB2383-4AC1	--	Inverse-time delayed protection, temperature-dependent protection, electrical remote RESET, overload warning	Power supply 24 ... 240 V AC/DC	Connection PTC sensor	Electrical remote RESET
	3RB2985-2CA1	Inverse-time delayed protection, temperature-dependent protection, internal ground-fault detection, electrical remote RESET, overload warning	Power supply 24 ... 240 V AC/DC	Connection PTC sensor	Electrical remote RESET
	3RB2985-2CB1	Inverse-time delayed protection, temperature-dependent protection, internal ground-fault detection, electrical remote RESET, ground-fault signal	Power supply 24 ... 240 V AC/DC	Connection PTC sensor	Electrical remote RESET
	3RB2985-2AA0	Inverse-time delayed protection, temperature-dependent protection, electrical remote RESET, overload warning, analog output	Power supply 24 ... 240 V AC/DC	Connection PTC sensor	Electrical remote RESET
	3RB2985-2AA1	Inverse-time delayed protection, temperature-dependent protection, internal ground-fault detection, electrical remote RESET, overload warning, analog output	Power supply 24 ... 240 V AC/DC	Connection PTC sensor	Electrical remote RESET
	3RB2985-2AB1	Inverse-time delayed protection, temperature-dependent protection, internal ground-fault detection, electrical remote RESET, ground-fault signal, analog output	Power supply 24 ... 240 V AC/DC	Connection PTC sensor	Electrical remote RESET

Evaluation modules	With function expansion module	Outputs				
		I (-) / I (+)	95/96 NC	97/98 NO	05/06 NC	07/08 NO
3RB2283-4AA1 3RB2283-4AC1 3RB2383-4AA1 3RB2383-4AC1	--	No	Disconnection of the contactor (inverse-time delayed/temperature-dependent protection)	Signal "tripped"	Overload warning	Overload warning
	3RB2985-2CA1	No	Disconnection of the contactor (inverse-time delayed/temperature-dependent protection + ground fault)	Signal "tripped"	Overload warning	Overload warning
	3RB2985-2CB1	No	Disconnection of the contactor (inverse-time delayed/temperature-dependent protection)	Signal "tripped"	Disconnection of the contactor (ground fault)	Signal "ground-fault tripping"
	3RB2985-2AA0	Analog signal	Disconnection of the contactor (inverse-time delayed/temperature-dependent protection)	Signal "tripped"	Overload warning	Overload warning
	3RB2985-2AA1	Analog signal	Disconnection of the contactor (inverse-time delayed/temperature-dependent protection + ground fault)	Signal "tripped"	Overload warning	Overload warning
	3RB2985-2AB1	Analog signal	Disconnection of the contactor (inverse-time delayed/temperature-dependent protection)	Signal "tripped"	Disconnection of the contactor (ground fault)	Signal "ground-fault tripping"

Overload Relays

SIRIUS 3RB2 Electronic Overload Relays

3RB22, 3RB23 for high-feature applications **IE3/IE4 ready**

3RB22 and 3RB23 electronic overload relays (evaluation modules) for full motor protection, stand-alone installation, CLASS 5E, 10E, 20E and 30E (adjustable)

Type	3RB2283-4A.1, 3RB2383-4A.1
Features and technical specifications	
Overload protection, phase failure protection and asymmetry protection	✓
Supplied from an external source	✓ 24 ... 240 V AC/DC
Auxiliary contacts	✓ 2 NO + 2 NC
Electrical remote RESET integrated	✓
Four LEDs for operating and status displays	✓
TEST function and self-monitoring	✓
Internal ground-fault detection	✓ (with function expansion module)
Screw or spring-type terminals for auxiliary, control and sensor circuits	✓
Input for PTC sensor circuit	✓
Analog output	✓ (with function expansion module)

✓ Available

Selection and ordering data



PU (UNIT, SET, M) = 1
 PS* = 1 unit
 PG = 41G



3RB2283-4AA1,
3RB2383-4AA1



3RB2283-4AC1,
3RB2383-4AC1

Size contactor	Version	SD	Screw terminals 		SD	Spring-type terminals 	
			Article No.	Price per PU		Article No.	Price per PU
		d			d		

Evaluation modules

S00 ... S12	Monostable	▶	3RB2283-4AA1	▶	3RB2283-4AC1
	Bistable	▶	3RB2383-4AA1	▶	3RB2383-4AC1

Notes:

Overview of overload relays – matching contactors, see page 7/76.

Current measuring modules and related connecting cables, see page 7/132, general accessories, see page 7/133 onwards.

Overload Relays SIRIUS 3RB2 Electronic Overload Relays

IE3/IE4 ready 3RB22, 3RB23 for high-feature applications

Function expansion modules for 3RB22 and 3RB23 overload relays (evaluation modules)

Size contactor	Version	For overload relays	SD	Article No.	Price per PU	PU (UNIT, SET, M)	PS*	PG	
Sizes S00 to S12									
 3RB2985-2..1	S00 ... S12	For plugging into evaluation module (1 unit)							
		Analog Basic 1 modules¹⁾ Analog output 4 ... 20 mA DC, with overload warning	3RB22, 3RB23	▶	3RB2985-2AA0		1	1 unit	41F
		Analog Basic 1 GF modules¹⁾²⁾ Analog output 4 ... 20 mA DC, with internal ground-fault detection and overload warning	3RB22, 3RB23	▶	3RB2985-2AA1		1	1 unit	41F
		Analog Basic 2 GF modules¹⁾²⁾ Analog output 4 ... 20 mA DC, with internal ground-fault detection and ground-fault signal	3RB22, 3RB23	▶	3RB2985-2AB1		1	1 unit	41F
		Basic 1 GF modules²⁾ with internal ground-fault detection and overload warning	3RB22, 3RB23	▶	3RB2985-2CA1		1	1 unit	41F
	Basic 2 GF modules²⁾ with internal ground-fault detection and ground-fault signal	3RB22, 3RB23	▶	3RB2985-2CB1		1	1 unit	41F	

- ¹⁾ The analog signal 4 mA up to 20 mA DC can be used for operating rotary coil instruments or for feeding into analog inputs of programmable logic controllers.
- ²⁾ The following information on ground-fault protection refers to sinusoidal residual currents at 50/60 Hz:
- With a motor current of between 0.3 and 2 times the current setting I_e , the unit will trip at a ground-fault current equal to 30 % of the current setting.
 - With a motor current of between 2 and 8 times the current setting I_e , the unit will trip at a ground-fault current equal to 15 % of the current setting.
 - The response delay amounts to between 0.5 s and 1 s.

Note:

Analog input modules, e.g. SM 331, must be configured for 4-wire measuring transducers. In this case the analog input module must not supply current to the analog output of the 3RB22/3RB23 relay.

Overload Relays

SIRIUS 3RB2 Electronic Overload Relays

3RB24 for IO-Link for high-feature applications

Overview

More information

Home page, see <http://www.siemens.com/sirius-overloadrelays>
Industry Mall, see www.siemens.com/product?3RB2

Application Manual "SIRIUS Controls with IE3/IE4 Motors", see <https://support.industry.siemens.com/cs/ww/en/view/94770820>
Manual "SIRIUS 3RB24 Electronic Overload Relay for IO-Link", see <https://support.industry.siemens.com/cs/ww/en/view/46165627>

Certificates, see <https://support.industry.siemens.com/cs/ww/en/ps/16281/cert>

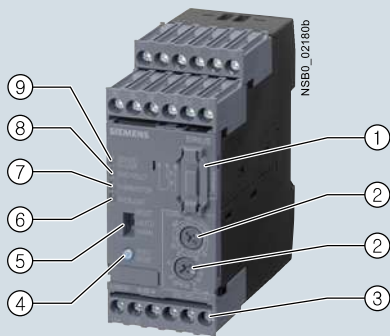

- ① Plug-in point for operator panel:
enables connection of the 3RA6935-0A operator panel.
- ② Motor current and trip class setting:
Setting the device to the motor current and to the required trip class dependent on the start-up conditions is easy with the two rotary switches.
- ③ Connecting terminals (removable terminal block):
The generously sized terminals permit connection of two conductors with different cross-sections for the auxiliary, control and sensor circuits. Connection is possible with screw connection and alternatively with spring-type connection.
- ④ Test/RESET button:
Enables testing of all important device components and functions, plus resetting of the device after a trip when manual RESET is selected.
- ⑤ Selector switch for manual/automatic RESET:
With this switch you can choose between manual and automatic RESET.
- ⑥ Red LED "OVERLOAD":
A continuous red light signals an active overload trip; a flickering led light signals an imminent trip (overload warning).
- ⑦ Red LED "THERMISTOR":
A continuous red light signals an active thermistor trip.
- ⑧ Red LED "GND FAULT":
A continuous red light signals an active ground-fault trip.
- ⑨ Green LED "DEVICE/IO-Link":
A continuous green light signals that the device is working correctly, a green flickering light signals the communication through IO-Link.

SIRIUS 3RB24 evaluation module

The modular, IO-Link powered 3RB24 electronic overload relays (with monostable auxiliary contacts) up to 630 A (up to 820 A possible with a series transformer) have been designed for current-dependent protection of loads with normal and heavy starting against excessive temperature rises due to overload, phase asymmetry or phase failure. It comprises an evaluation unit, a current measuring module and a connecting cable.

The evaluation module 3RB24 also offers an engine starter function: The contactors, which are connected via the auxiliary contacts, can also be actuated for operation via IO-Link. In this way, direct-on-line, reversing and wye-delta starters up to 630 A (or 830 A) can be connected to the controller wirelessly via the IO-Link controller.

An overload, phase asymmetry or phase failure result in an increase of the motor current beyond the set rated motor current.

This current rise is detected by means of the current measuring module (see page 7/132) and electronically evaluated by the evaluation module which is connected to it. The evaluation electronics sends a signal to the auxiliary contacts. The auxiliary contacts then switch off the load by means of a contactor.

The break time depends on the ratio between the tripping current and current setting I_e and is stored in the form of a long-term stable tripping characteristic curve (see Manual). The "tripped" status is signaled by means of a continuously illuminated red "OVERLOAD" LED and also reported as a group fault via IO-Link.

The LED indicates imminent tripping of the relay due to overload, phase asymmetry or phase failure by flickering when the limit current has been violated. This warning can also be reported to the higher-level PLC via IO-Link at the 3RB24 overload relay.

In addition to the described inverse-time delayed protection of loads against excessive temperature rises, the 3RB24 electronic overload relays also allow direct temperature monitoring of the motor windings (full motor protection) by connection with broken-wire interlock of a PTC sensor circuit. With this temperature-dependent protection, the loads can be protected against overheating caused, for example, indirectly by reduced coolant flow and which cannot be detected by means of the current alone. In the event of overheating, the devices switch off the contactor, and thus the load, by means of the auxiliary contacts. The "tripped" status is signaled by means of a continuously illuminated "THERMISTOR" LED and also reported as a group fault via IO-Link.

To protect the loads against incomplete ground faults due to damage to the insulation, humidity, condensation, etc., the 3RB24 electronic overload relays offer the possibility of internal ground-fault detection (for details, see Manual, not possible in conjunction with contactor assemblies for star-delta (wye-delta) starting). In the event of a ground fault, the 3RB24 relays trip instantaneously.

The "tripped" status is signaled by means of a flashing red LED "Ground Fault" and reported at the overload relay 3RB24 as a group fault via IO-Link.

The reset after overload, phase asymmetry, phase failure, thermistor or ground-fault tripping is performed manually by key on site, via IO-Link or by electrical remote RESET or automatically after the cooling time (motor model) or for thermistor protection after sufficient cooling. Trips in devices initiated by function monitoring systems (broken wire or short-circuit on the thermistor) can only be reset locally.

A motor current measured by the microprocessor can be output in the form of an analog signal DC 4 mA to 20 mA for operating rotary coil instruments or for feeding into analog inputs of programmable logic controllers.

Overload Relays

SIRIUS 3RB2 Electronic Overload Relays

3RB24 for IO-Link for high-feature applications

The current values can be transmitted to the higher-level controller via IO-Link.

The 3RB24 electronic overload relay for IO-Link is suitable for operation with frequency converters.

The devices are manufactured in accordance with environmental guidelines and contain environmentally friendly and reusable materials. They comply with all important worldwide standards and approvals.

Use in hazardous areas

The 3RB24 electronic overload relays for IO-Link with the 3RB29 current measuring module are suitable for the overload protection of motors with the following types of protection:

- Ex II (2) G [Ex e] [Ex d] [Ex px]
- Ex II (2) D [Ex t] [Ex p]

EC type test certificate for Group II, Category (2) G/D exists. It has the number PTB 11 ATEX 3014.

Article No. scheme

Product versions	Article number
Electronic overload relays	3RB2 □ □ □ - □ □ □ □
Device type	e. g. 4 = monostable device for high-feature applications, supplied from external source (24 V DC), for three-phase loads □
Size, rated operational current and power	e. g. 8 = irrespective of size and current □
Version of the automatic RESET, electrical remote RESET	e. g. 3 = switchable between manual/auto RESET, with integral electrical remote RESET □
Trip class (CLASS)	e. g. 4 = CLASS 5E, 10E, 20E, 30E (adjustable) □
Setting range of the overload release	e.g. A = none specified □
Connection methods	e.g. A = screw terminals for auxiliary, control and main circuits □
Installation type	e. g. 1 = stand-alone installation □
Example	3RB2 4 8 3 - 4 A A 1

Note:

The Article No. scheme shows an overview of product versions for better understanding of the logic behind the article numbers.

For your orders please use the article numbers quoted in the selection and ordering data.

Benefits

The most important features and benefits of the 3RB24 electronic overload relays for IO-Link are listed in the overview table (see "General Data", page 7/71 onwards).

Advantages through energy efficiency

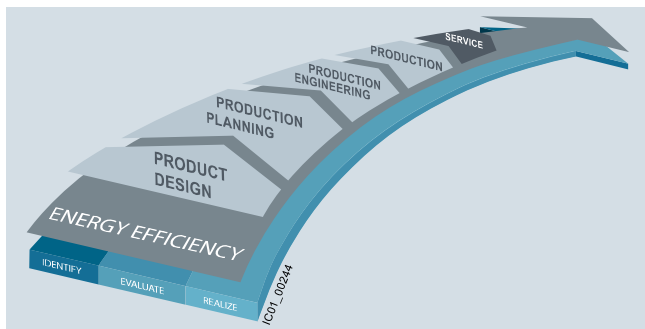

Overview of the energy management process

We offer you a unique portfolio for industrial energy management, using an energy management system that helps to optimally define your energy needs. We split up our industrial energy management into three phases – identify, evaluate, and realize – and we support you with the appropriate hardware and software solutions in every process phase. The innovative products of the SIRIUS industrial controls portfolio can also make a substantial contribution to a plant's energy efficiency (see www.siemens.com/sirius/energysaving).

3RB24 electronic overload relays for IO-Link contribute to energy efficiency throughout the plant as follows:

- Transmission of current values
- Reduced inherent power loss
- Less heating of the control cabinet
- Smaller control cabinet air conditioners can be used

Overload Relays

SIRIUS 3RB2 Electronic Overload Relays

3RB24 for IO-Link for high-feature applications

Application

Industries

The 3RB24 electronic overload relays are suitable for customers from all industries who want to guarantee optimum current and temperature-dependent protection of their electrical loads (e.g. motors) under normal and heavy starting conditions (CLASS 5E to 30E), minimize project completion times, inventories and energy consumption, and optimize plant availability and maintenance management.

Application

The 3RB24 electronic overload relays have been designed for the protection of three-phase asynchronous and single-phase AC motors.

In addition to protection function, these devices can be used together with contactors as direct or reversing starters (star-delta (wye-delta) start also possible), which are controlled via IO-Link. This makes it possible to directly control drives via IO-Link from a higher-level controller or on site via the optional hand-held device and also, for example, to return current values directly via IO-Link.

If single-phase AC motors are to be protected by the 3RB24 electronic overload relays, the main current paths of the current measuring modules must be series-connected. (Circuit Diagrams see Manual).

Ambient conditions

The devices are insensitive to external influences such as shocks, corrosive ambient conditions, ageing and temperature fluctuations.

In the temperature range from -25 °C to +60 °C, the 3RB24 electronic overload relays compensate the temperature in accordance with IEC 60947-4-1.

Configuration notes for use of the devices below -25°C or above +60°C on request.

Use of SIRIUS protection devices in conjunction with IE3/IE4 motors

Note:

For the use of 3RB24 electronic overload relays in conjunction with highly energy-efficient IE3/IE4 motors, please observe the information on dimensioning and configuring, see [Application Manual](#).

For more information, see [Preface on page 7](#).

Technical specifications

More information

Application Manual "SIRIUS Controls with IE3/IE4 Motors", see <https://support.industry.siemens.com/cs/ww/en/view/94770820>
 Configuration Manual "Configuring SIRIUS Innovations – Selection Data for Fuseless and Fused Load Feeders", see <https://support.industry.siemens.com/cs/ww/en/view/39714188>

Manual "SIRIUS 3RB24 Electronic Overload Relay for IO-Link", see <https://support.industry.siemens.com/cs/ww/en/view/46165627>
 Technical specifications, see <https://support.industry.siemens.com/cs/ww/en/ps/16281/td>

The following technical information is intended to provide an initial overview of the various types of device and functions.

Type – Overload relay: evaluation modules Size contactor Dimensions of evaluation modules (W x H x D)		3RB2483-4A.1 S00 ... S10/S12 45 x 111 x 95 mm
General data		
Tripping in the event of		Overload, phase failure and phase asymmetry (> 40 % according to NEMA), + ground fault (connectable and disconnectable) and activation of the thermistor motor protection (with closed PTC sensor circuit)
Trip class acc. to IEC 60947-4-1	CLASS	5E, 10E, 20E and 30E adjustable
Phase failure sensitivity		Yes
Overload warning		Yes, from $1.125 \times I_e$ for symmetrical loads and from $0.85 \times I_e$ for unsymmetrical loads
Reset and recovery		Manual and automatic RESET, electrical remote RESET or through IO-Link
<ul style="list-style-type: none"> • Reset options after tripping • Recovery time <ul style="list-style-type: none"> - For automatic RESET - For manual RESET - For remote RESET 	min. min. min.	<ul style="list-style-type: none"> - For tripping due to overcurrent: 3 (stored permanently), - For tripping by thermistor: Time until the motor temperature has fallen 5 K below the response temperature, - For tripping due to a ground fault: no automatic RESET - For tripping due to overcurrent: 3 (stored permanently), - For tripping by thermistor: Time until the motor temperature has fallen 5 K below the response temperature, - For tripping due to a ground fault: Immediately - For tripping due to overcurrent: 3 (stored permanently), - For tripping by thermistor: Time until the motor temperature has fallen 5 K below the response temperature, - For tripping due to a ground fault: Immediately

Overload Relays

SIRIUS 3RB2 Electronic Overload Relays



3RB24 for IO-Link for high-feature applications

Type – Overload relay: evaluation modules			3RB2483-4A.1
Size contactor			S00 ... S10/S12
Dimensions of evaluation modules (W x H x D)		mm	45 x 111 x 95
General data (continued)			
Features			
• Display of operating state on device			Yes, with four LEDs: <ul style="list-style-type: none"> - Green "DEVICE/IO-Link" LED - Red LED "Ground Fault" - Red LED "Thermistor" - Red "Overload" LED
• TEST function			Yes, test of LEDs, electronics, auxiliary contacts and wiring of control circuit by pressing the button TEST/RESET / self-monitoring
• RESET button			Yes, with the TEST/RESET button
• STOP button			No
Protection and operation of explosion-proof motors			
EC type-examination certificate number according to directive 2014/34/EU (ATEX)			PTB 11 ATEX 3014 II (2) G [Ex e] [Ex d] [Ex px] II (2) G [Ex t] [Ex p] see https://support.industry.siemens.com/cs/ww/en/view/60524083
Ambient temperatures			
• Storage/transport	°C		-40 ... +80
• Operation	°C		-25 ... +60
• Temperature compensation	°C		+60
• Permissible rated current			
- Temperature inside control cabinet 60 °C	%		100
- Temperature inside control cabinet 70 °C	%		On request
Degree of protection acc. to IEC 60529			IP20
Touch protection acc. to IEC 60529			Finger-safe
Shock resistance with sine acc. to IEC 60068-2-27	g/ms		15/11
Electromagnetic compatibility (EMC) – Interference immunity			
• Conductor-related interference			
- Burst acc. to IEC 61000-4-4 (corresponds to degree of severity 3)	kV		2 (power ports), 1 (signal port)
- Surge acc. to IEC 61000-4-5 (corresponds to degree of severity 3)	kV		2 (line to earth), 1 (line to line)
• Electrostatic discharge according to IEC 61000-4-2 (corresponds to degree of severity 3)	kV		8 (air discharge), 6 (contact discharge)
• Field-related interference acc. to IEC 61000-4-3 (corresponds to degree of severity 3)	V/m		10
Electromagnetic compatibility (EMC) – Emitted interference			
			Degree of severity A according to EN 55011 (CISPR 11) and EN 55022 (CISPR 22)
Resistance to extreme climates – air humidity	%		100
Installation altitude above sea level	m		Up to 2 000
Mounting position			Any
Type of mounting			
• Evaluation modules			Stand-alone installation
• Current measuring module	Size		S00 to S3: Stand-alone installation, S6 and S10/S12: Stand-alone installation or mounting onto contactors

Overload Relays

SIRIUS 3RB2 Electronic Overload Relays

3RB24 for IO-Link for high-feature applications



Type – Overload relay: evaluation modules	3RB2483-4A.1	
Size contactor	S00 ... S10/S12	
Auxiliary circuit		
Number of auxiliary switches	1 CO contact, 1 NO contact connected in series internally	
Auxiliary contacts – assignment	<ul style="list-style-type: none"> • 1 CO contact for selecting the contactor (for reversing starter function), actuated by the control system • 1 NO contact for normal switching duty, actuated by the control system (opens automatically when tripping occurs) 	
Rated insulation voltage U_i (pollution degree 3)	V	300
Rated impulse withstand voltage U_{imp}	kV	4
Auxiliary contacts – contact rating		
<ul style="list-style-type: none"> • NC, NO contact with alternating current AC-14/AC-15, rated operational current I_e at U_e <ul style="list-style-type: none"> - 24 V - 120 V - 125 V - 250 V • NC, NO contacts with DC current DC-13, rated operational current I_e at U_e <ul style="list-style-type: none"> - 24 V - 60 V - 110 V - 125 V - 250 V • Conventional thermal current I_{th} • Contact reliability (suitability for PLC control; 17 V, 5 mA) 	A	6 6 6 3 2 0.55 0.3 0.3 0.2 5 Yes
Short-circuit protection		
<ul style="list-style-type: none"> • With fuse, operational class gG • With miniature circuit breaker, C characteristic 	A	6 1.6
Protective separation between auxiliary current paths Acc. to IEC 60947-1	V	300
CSA, UL, UR rated data		
Auxiliary circuit – switching capacity	B300, R300	
Conductor cross-sections of the auxiliary circuit		
Connection type	 Screw terminals	
Terminal screw	M3, Pozidriv size 2	
Operating devices	mm	3.0 x 0.5
Prescribed tightening torque	Nm	0.8 ... 1.2
Conductor cross-sections (min./max.), 1 or 2 conductors can be connected		
• Solid or stranded	mm ²	1 x (0.5 ... 4) ¹⁾ , 2 x (0.5 ... 2.5) ¹⁾
• Finely stranded without end sleeve	mm ²	–
• Finely stranded with end sleeve (DIN 46228-1)	mm ²	1 x (0.5 ... 2.5) ¹⁾ , 2 x (0.5 ... 1.5) ¹⁾
• AWG cables, solid or stranded	AWG	2 x (20 ... 14)
Connection type	 Spring-type terminals	
Operating devices	mm	3.0 x 0.5
Conductor cross-sections (min./max.), 1 or 2 conductors can be connected		
• Solid or stranded	mm ²	2 x (0.25 ... 1.5)
• Finely stranded without end sleeve	mm ²	–
• Finely stranded with end sleeve (DIN 46228-1)	mm ²	2 x (0.25 ... 1.5)
• AWG cables, solid or stranded	AWG	2 x (24 ... 16)

¹⁾ If two different conductor cross-sections are connected to one clamping point, both cross-sections must be in the range specified.

Overload Relays

SIRIUS 3RB2 Electronic Overload Relays

3RB24 for IO-Link for high-feature applications

Type – Overload relay: evaluation modules	3RB2483-4A.1	
Size contactor	S00 ... S10/S12	
Control circuit		
Rated insulation voltage U_i (pollution degree 3)	V	300
Rated impulse withstand voltage U_{imp}	kV	4
Rated control supply voltage U_s¹⁾	V	24 through IO-Link
• DC		
Operating range		
• DC		$0.85 \times U_{s \min} \leq U_s \leq 1.1 \times U_{s \max}$
Rated power		
• DC	W	0.5
Mains buffering time	ms	200
Sensor circuit		
Thermistor motor protection (PTC thermistor sensor)		
• Summation cold resistance	k Ω	≤ 1.5
• Response value	k Ω	3.4 ... 3.8
• Return value	k Ω	1.5 ... 1.65
Ground-fault detection		The information refers to sinusoidal residual currents at 50/60 Hz.
• Tripping value I_{Δ}		
- For $0.3 \times I_e < I_{motor} < 2.0 \times I_e$		$> 0.3 \times I_e$
- For $2.0 \times I_e < I_{motor} < 8.0 \times I_e$		$> 0.15 \times I_{motor}$
• Response time t_{trip}	ms	500 ... 1 000
Analog output¹⁾		
Rated values		
• Output signal	mA	4 ... 20
• Measuring range		0 ... $1.25 \times I_e$ 4 mA is equivalent to $0 \times I_e$ 16.8 mA is equivalent to $1.0 \times I_e$ 20 mA is equivalent to $1.25 \times I_e$
• Load, max.	Ω	100
Conductor cross-sections for the control and sensor circuits as well as the analog output		
Connection type	 Screw terminals	
Terminal screw	M3, Pozidriv size 2	
Operating devices	mm	3.0 x 0.5
Prescribed tightening torque	Nm	0.8 ... 1.2
Conductor cross-sections (min./max.), 1 or 2 conductors can be connected		
• Solid	mm ²	$1 \times (0.5 \dots 4)^2, 2 \times (0.5 \dots 2.5)^2$
• Finely stranded without end sleeve	mm ²	--
• Finely stranded with end sleeve (DIN 46228-1)	mm ²	$1 \times (0.5 \dots 2.5)^2, 2 \times (0.5 \dots 1.5)^2$
• Stranded	mm ²	--
• AWG cables, solid or stranded	AWG	$2 \times (20 \dots 14)$
Connection type	 Spring-type terminals	
Operating devices	mm	3.0 x 0.5
Conductor cross-sections (min./max.), 1 or 2 conductors can be connected		
• Solid	mm ²	$2 \times (0.25 \dots 1.5)$
• Finely stranded without end sleeve	mm ²	--
• Finely stranded with end sleeve (DIN 46228-1)	mm ²	$2 \times (0.25 \dots 1.5)$
• Stranded	mm ²	$2 \times (0.25 \dots 1.5)$
• AWG cables, solid or stranded	AWG	$2 \times (24 \dots 16)$

¹⁾ Analog input modules, e.g. SM 331, must be configured for 4-wire measuring transducers. The analog input module may not supply current to the analog output of the 3RB24 overload relay.

²⁾ If two different conductor cross-sections are connected to one clamping point, both cross-sections must be in the range specified.

Overload Relays

SIRIUS 3RB2 Electronic Overload Relays

3RB24 for IO-Link for high-feature applications **IE3/IE4 ready**

3RB24 electronic overload relays (evaluation modules) for full motor protection, stand-alone installation, CLASS 5E, 10E, 20E and 30E (adjustable)

Type	3RB2483-4A.1
Features and technical specifications	
Overload protection, phase failure protection and asymmetry protection	✓
Supplied from an external source	✓ 24 V DC through IO-Link
Direct-on-line or reversing starters (wye-delta starting also possible) controllable through IO-Link	✓
Auxiliary contacts	✓ 1 CO and 1 NO in series
Manual and automatic RESET	✓
Remote RESET	✓ (electrically or via IO-Link)
Four LEDs for operating and status displays	✓
TEST function and self-monitoring	✓
Internal ground-fault detection	✓
Screw or spring-type terminals for auxiliary, control and sensor circuits	✓
Input for PTC sensor circuit	✓
Analog output	✓
IO-Link-specific functions	
• Connection of direct-on-line, reversing and star-delta starters to the controller via IO-Link	✓
• On-site controlling of the starter using the hand-held device	✓
• Accessing process data (e.g. current values in all three phases) via IO-Link	✓
• Accessing parameterization and diagnostics data (e.g. tripped signals) via IO-Link	✓

✓ Available

Selection and ordering data



PU (UNIT, SET, M) = 1
 PS* = 1 unit
 PG = 41G



3RB2483-4AA1



3RB2483-4AC1

Size contactor	Version	SD	Screw terminals 	SD	Spring-type terminals 	
		d	Article No.	Price per PU d	Article No.	Price per PU

Evaluation modules

S00 ... S12	Monostable	▶	3RB2483-4AA1	2	3RB2483-4AC1
-------------	------------	---	---------------------	---	---------------------

Notes:

- Overview table of overload relays – matching contactors, [see page 7/76](#)
- Analog input modules, e.g. SM 331, must be configured for 4-wire measuring transducers. The analog input module may not supply current to the analog output of the 3RB24 relay.

Current measuring modules and related connecting cables, [see page 7/132](#), "Accessories", [see page 7/133 onwards](#).

Overload Relays

SIRIUS 3RB2 Electronic Overload Relays

Current measuring modules for 3RB22, 3RB23, 3RB24

Overview

More information

Home page, see <http://www.siemens.com/sirius-overloadrelays>
Industry Mall, see www.siemens.com/product?3RB2

Application Manual "SIRIUS Controls with IE3/IE4 Motors", see <https://support.industry.siemens.com/cs/ww/en/view/94770820>
Other Manuals, see <https://support.industry.siemens.com/cs/ww/en/ps/16282/man>



SIRIUS 3RB2906 current measuring module

The current measuring modules are designed as system components for connecting to evaluation units 3RB22 to 3RB24. Using these evaluation units the motor current is measured and the measured value sent to the evaluation unit for evaluation.

The current measuring modules in sizes up to S3 are equipped with straight-through transformers and can be snap-fitted under the evaluation units. The larger evaluation units are installed directly on the contactor or as stand-alone units.

Application

Use of SIRIUS protection devices in conjunction with IE3/IE4 motors

Note:

For the use of current measuring modules for 3RB22, 3RB23, 3RB24 in conjunction with highly energy-efficient IE3/IE4 motors, please read the information on dimensioning and configuration, see [Application Manual](#).

For more information, see [Preface on page 7](#).

Overload Relays

SIRIUS 3RB2 Electronic Overload Relays

Current measuring modules for 3RB22, 3RB23, 3RB24

Technical specifications

More information

Manuals, see <https://support.industry.siemens.com/cs/ww/en/ps/16282/man>

Technical specifications, see <https://support.industry.siemens.com/cs/ww/en/ps/16282/td>



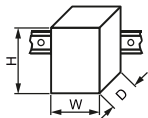

The following technical information is intended to provide an initial overview of the various types of device and functions.

Type – Overload relays: Current measuring modules		3RB2906		3RB2956		3RB2966	
Size contactor		S00/S0	S2/S3	S6		S10/S12	
Dimensions of current measuring modules (W x H x D)		45 x 84 x 45	55 x 94 x 72	120 x 119 x 145		145 x 147 x 148	
Main circuit							
Rated insulation voltage U_i (pollution degree 3)	V	1 000					
Rated impulse withstand voltage U_{imp}	kV	6		8			
Rated operational voltage U_e	V	1 000					
Type of current		No		Yes, 50/60 Hz ± 5 %			
• Direct current		No		Yes, 50/60 Hz ± 5 %			
• Alternating current		Yes, 50/60 Hz ± 5 %		No			
Current setting	A	0.3 ... 3; 2.4 ... 25	10 ... 100	20 ... 200		63 ... 630	
Power loss per unit (max.)	W	0.5					
Short-circuit protection							
• With fuse without contactor				see "Selection and Ordering Data", page 7/132			
• With fuse and contactor				See Configuration Manuals			
				• "Configuring SIRIUS Innovations – Selection Data for Fuseless and Fused Load Feeders"			
				• "SIRIUS Configuration – Selection Data for Fuseless Load Feeders"			
Degree of protection acc. to IEC 60529							
• Screw terminals/busbar connections		IP20		- IP20 (front side) - Terminal IP00 (use additional terminal covers for higher degree of protection)			
• Straight-through transformers		IP20		IP20		--	
Touch protection acc. to IEC 60529							
• Screw terminals/busbar connections		Finger-safe		Finger-safe with terminal covers for vertical contact from the front			
• Straight-through transformers		Finger-safe		Finger-safe		--	
Protective separation between main and auxiliary current paths acc. to IEC 60947-1 (pollution degree 2)							
• For systems with grounded neutral point	V	690					
• For systems with ungrounded neutral point	V	600					

Overload Relays

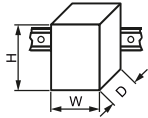
SIRIUS 3RB2 Electronic Overload Relays

Current measuring modules for 3RB22, 3RB23, 3RB24

Type – Overload relays: Current measuring modules				3RB2906	3RB2956	3RB2966
Size contactor			mm	S00/S0	S2/S3	S6
Dimensions of current measuring modules (W x H x D)				45 x 84 x 45	55 x 94 x 72	120 x 119 x 145
Conductor cross-sections of main circuit						
Connection type		 Screw terminals with box terminal				
Terminal screw	mm	--		4 mm Allen screw	5 mm Allen screw	
Operating devices	mm	--		4 mm Allen screw	5 mm Allen screw	
Prescribed tightening torque	Nm	--		10 ... 12	20 ... 22	
Conductor cross-sections (min./max.), 1 or 2 conductors can be connected						
• Solid or stranded	mm ²	--		With box terminal 3RT1955-4G: 2 x (max. 70), 1 x (16 ... 70)	2 x (70 ... 240), Front clamping point only: 1 x (95 ... 300)	
				With box terminal 3RT1956-4G: 2 x (max. 120), 1 x (16 ... 120)	Rear clamping point only: 1 x (120 ... 240)	
• Finely stranded without end sleeve	mm ²	--		With box terminal 3RT1955-4G: 2 x (1 x max. 50, 1 x max. 70), 1 x (10 ... 70)	2 x (50 ... 185), Front clamping point only: 1 x (70 ... 240)	
				With box terminal 3RT1956-4G: 2 x (1 x max. 95, 1 x max. 120), 1 x (10 ... 120)	Rear clamping point only: 1 x (120 ... 185)	
• Finely stranded with end sleeve (DIN 46228-1)	mm ²	--		With box terminal 3RT1955-4G: 2 x (1 x max. 50, 1 x max. 70), 1 x (10 ... 70)	2 x (50 ... 185), Front clamping point only: 1 x (70 ... 240)	
				With box terminal 3RT1956-4G: 2 x (1 x max. 95, 1 x max. 120), 1 x (10 ... 120)	Rear clamping point only: 1 x (120 ... 185)	
• AWG cables	AWG	--		With box terminal 3RT1955-4G: 2 x (max. 1/0), 1 x (6 ... 2/0)	2 x (2/0 ... 500 kcmil), Front clamping point only: 1 x (3/0 ... 600 kcmil)	
				With box terminal 3RT1956-4G: 2 x (max. 3/0), 1 x (6 ... 250 kcmil)	Rear clamping point only: 1 x (250 kcmil ... 500 kcmil)	
• Ribbon cables (Number x Width x Thickness)	mm	--		With box terminal 3RT1955-4G: 2 x (6 x 15.5 x 0.8), 1 x (3 x 9 x 0.8 ... 6 x 15.5 x 0.8)	2 x (20 x 24 x 0.5), 1 x (6 x 9 x 0.8 ... 20 x 24 x 0.5)	
				With box terminal 3RT1956-4G: 2 x (10 x 15.5 x 0.8), 1 x (3 x 9 x 0.8 ... 10 x 15.5 x 0.8)		
Connection type		 Busbar connections				
Terminal screw		--		M8 x 25	M10 x 30	
Prescribed tightening torque	Nm	--		10 ... 14	14 ... 24	
Conductor cross-sections (min./max.), 1 or 2 conductors can be connected						
• Solid with cable lug	mm ²	--		16 ... 95 ¹⁾	50 ... 240 ²⁾	
• Stranded with cable lug	mm ²	--		25 ... 120 ¹⁾	70 ... 240 ²⁾	
• AWG cables, solid or stranded, with cable lug	AWG	--		4 ... 250 kcmil	2/0 ... 500 kcmil	
• With connecting bars (max. width)	mm	--		17	25	
Connection type		 Straight-through transformers				
Diameter of opening	mm	7.5	14	25	--	

¹⁾ When connecting cable lugs according to DIN 46235 with conductor cross-sections of 95 mm² and more, the 3RT1956-4EA1 terminal cover must be used to ensure phase clearance, see page 7/133.

²⁾ When connecting cable lugs according to DIN 46234 for conductor cross-sections from 240 mm², as well as DIN 46235 for cable cross-sections from 185 mm², the 3RT1956-4EA1 terminal cover must be used to ensure phase clearance, see page 7/133.

Overload Relays

SIRIUS 3RB2 Electronic Overload Relays

Current measuring modules for 3RB22, 3RB23, 3RB24 **IE3/IE4 ready**

Selection and ordering data

Current measuring modules (essential accessories)



Size contactor	Current setting value of the inverse-time delayed overload release	Short-circuit protection with fuse, type of coordination "2", operational class gG ¹⁾	For overload relays	SD	Article No.	Price per PU	PU (UNIT, SET, M)	PS*	PG
3RB2906-2BG1, 3RB2906-2DG1	A	A		d					
Sizes S00/S0									
Devices with straight-through transformer for stand-alone installation									
S00/S0	0.3 ... 3 2.4 ... 25	20 63	3RB22 to 3RB24	▶	3RB2906-2BG1 3RB2906-2DG1		1 1	1 unit 1 unit	41G 41G
Sizes S2/S3									
Devices with straight-through transformer for stand-alone installation									
S2/S3	10 ... 100	315	3RB22 to 3RB24	▶	3RB2906-2JG1		1	1 unit	41G
Size S6									
Devices with busbar connection for mounting onto contactor and stand-alone installation									
S6	20 ... 200	315	3RB22 to 3RB24	▶	3RB2956-2TH2		1	1 unit	41G
Devices with straight-through transformer for mounting onto contactor and stand-alone installation									
For mounting onto S6 contactors with box terminals	20 ... 200	315	3RB22 to 3RB24	▶	3RB2956-2TG2		1	1 unit	41G
Sizes S10/S12²⁾									
Devices with busbar connection for mounting onto contactor and stand-alone installation									
S10/S12 and size 14 (3TF68/3TF69) ²⁾	63 ... 630	800	3RB22 to 3RB24	▶	3RB2966-2WH2		1	1 unit	41G

1) Maximum protection by fuse only for overload relays, type of coordination "2". For fuse values in connection with contactors, see Configuration Manuals
 - "Configuring SIRIUS Innovations – Selection Data for Fuseless and Fused Load Feeders",
 - "SIRIUS Configuration – Selection Data for Fuseless Load Feeders".
 2) For 3TF68/3TF69 contactors, direct mounting is not possible.

Note:

The connecting cable between the current measuring module and the evaluation module is not included in the scope of supply; please order separately (see "Accessories").

Accessories

Size contactor	Version	For overload relays	SD	Article No.	Price per PU	PU (UNIT, SET, M)	PS*	PG
Connecting cables (essential accessories)								
	S00 ... S3	For connection between evaluation module and current measuring module • Length 0.1 m (only for mounting of the evaluation module directly onto the current measuring module)	3RB22 to 3RB24	▶	3RB2987-2B		1	1 unit 41F
	S00 ... S12	• Length 0.5 m	3RB22 to 3RB24	▶	3RB2987-2D		1	1 unit 41F

Additional general accessories, see page 7/133.

Overload Relays

SIRIUS 3RB2 Electronic Overload Relays

Accessories for 3RB22, 3RB23, 3RB24

Overview

More information

Home page, see <http://www.siemens.com/sirius-overloadrelays>
Industry Mall, see www.siemens.com/product?3RB2

Manuals, see <https://support.industry.siemens.com/cs/ww/en/ps/16283/man>

The following optional accessories are available for the 3RB22 to 3RB24 electronic overload relays:





- Operator panel for the evaluation modules 3RB24
- Sealable cover for the evaluation modules 3RB22 to 3RB24
- Terminal covers for the 3RB29 current measuring modules size S6 and S10/S12
- Box terminal blocks for the 3RB29 current measuring modules size S6 and S10/S12
- Push-in lugs for screw fixing for 3RB22 to 3RB24 evaluation modules and 3RB2906 current measuring modules

Selection and ordering data

Accessories for 3RB24 overload relays

Version	For overload relays	SD	Article No.	Price per PU	PU (UNIT, SET, M)	PS*	PG
d							
Operator panels for evaluation modules							
 3RA6935-0A	Operator panels (set)	3RB24	10	3RA6935-0A	1	1 unit	42F
One set comprises:							
• 1 x operator panel							
• 1 x 3RA6936-0A enabling module							
• 1 x 3RA6936-0B interface cover							
• 1 x fixing terminal							
<u>Note:</u>							
The connecting cable between the evaluation module and the operator panel is not included in the scope of supply; please order separately.							
	Connecting cables	3RB24	▶	3UF7933-0BA00-0	1	1 unit	42J
Length 2.5 m (round), for connecting the evaluation module to the operator panel							
	Enabling modules (replacement)	3RB24	10	3RA6936-0A	1	1 unit	42F
	Interface covers	3RB24	10	3RA6936-0B	1	5 units	42F

General accessories

Version	Size	For overload relays	SD	Article No.	Price per PU	PU (UNIT, SET, M)	PS*	PG
d								
Sealable covers for evaluation modules								
 3RB2984-2	For covering the setting knobs	--	3RB22 to 3RB24	▶	3RB2984-2	1	10 units	41F
Terminal covers for current measuring modules								
 3RT1956-4EA1	Covers for cable lugs and busbar connections	S6	3RB2956	▶	3RT1956-4EA1	1	1 unit	41B
	• Length 100 mm	S10/S12	3RB2966	▶	3RT1966-4EA1	1	1 unit	41B
	• Length 120 mm							
 3RT1956-4EA2	Covers for box terminals	S6	3RB2956	▶	3RT1956-4EA2	1	1 unit	41B
	• Length 25 mm	S10/S12	3RB2966	▶	3RT1966-4EA2	1	1 unit	41B
	• Length 30 mm							
	Covers for screw terminals	S6	3RB2956	▶	3RT1956-4EA3	1	1 unit	41B
	between contactor and overload relay, without box terminals (1 unit required per combination)	S10/S12	3RB2966	▶	3RT1966-4EA3	1	1 unit	41B
Box terminal blocks for current measuring modules								
 3RT195.-4G	For round and ribbon cables	S6 ¹⁾	3RB2956	▶	3RT1955-4G	1	1 unit	41B
	• Up to 70 mm ²	S6	3RB2956	▶	3RT1956-4G	1	1 unit	41B
	• Up to 120 mm ²	S10/S12	3RB2966	▶	3RT1966-4G	1	1 unit	41B
	• Up to 240 mm ²							

¹⁾ In the scope of supply for 3RT1054-1 contactors (55 kW).



Overload Relays

SIRIUS 3RB2 Electronic Overload Relays

Accessories for 3RB22, 3RB23, 3RB24



Version	Size	For overload relays	SD	Article No.	Price per PU	PU (UNIT, SET, M)	PS*	PG
---------	------	---------------------	----	-------------	--------------	-------------------	-----	----

Push-in lugs for evaluation modules and current measuring modules

 3RP1903	For screw fixing the evaluation modules	--	3RB22 to 3RB24	5	3RP1903		1	10 units	41H
 3RB1900-0B	For screw fixing the current measuring modules (2 units required per module)	S00 .. S3	3RB2906	2	3RB1900-0B		100	10 units	41F

Version	Size	Color	For overload relays	SD	Article No.	Price per PU	PU (UNIT, SET, M)	PS*	PG
---------	------	-------	---------------------	----	-------------	--------------	-------------------	-----	----

Tools for opening spring-type terminals

 3RA2908-1A	Screwdrivers For all SIRIUS devices with spring-type terminals	Length, approx. 200 mm, 3.0 mm x 0.5 mm	Titanium gray/black, partially insulated	Main and auxiliary circuit connection: 3RB2	2	3RA2908-1A		1	1 unit	41B
---	--	---	--	---	---	-------------------	---	---	--------	-----

Blank labels

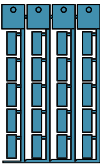
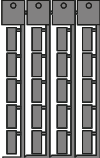
 3RT1900-1SB20	Unit labeling plates¹⁾ For SIRIUS devices	20 mm x 7 mm	Pastel turquoise	3RB2	20	3RT1900-1SB20		100	340 units	41B
		20 mm x 7 mm	Titanium gray	3RB2	20	3RT2900-1SB20		100	340 units	41B
	Adhesive inscription labels¹⁾ For SIRIUS devices	19 mm x 6 mm	Pastel turquoise	3RU2	15	3RT1900-1SB60		100	3 060 units	41B
 3RT2900-1SB20		19 mm x 6 mm	Zinc yellow	3RU2	15	3RT1900-1SD60		100	3 060 units	41B

¹⁾ PC labeling system for individual inscription of unit labeling plates available from: murrplastik Systemtechnik GmbH (see page 16/20).