



Modular Type Regulators *Series AR*

Regulator Series AR	Model	Port size	Options
 <p data-bbox="167 958 496 992">Pages 346 through to 355</p>	AR10	M5 x 0.8	
	AR20	1/8, 1/4	
	AR25	1/4, 3/8	
	AR30	1/4, 3/8	
	AR40	1/4, 3/8, 1/2	
	AR40-06	3/4	
	AR50	3/4, 1	
 <p data-bbox="167 1384 496 1417">Pages 346 through to 355</p>	AR20K	1/8, 1/4	Bracket Square embedded type pressure gauge (except the AR10) Round type pressure gauge Digital pressure switch (except the AR10) Panel mount
	AR25K	1/4, 3/8	
	AR30K	1/4, 3/8	
	AR40K	1/4, 3/8, 1/2	
	AR40K-06	3/4	
	AR50K	3/4, 1	
	AR60K	1	

AC

AF□

AR

AL

AW□

A□G

AV

AF800
AF900

Regulator

AR10 to AR60

Regulator with Backflow Function

AR20K to AR60K

JIS Symbol
Regulator

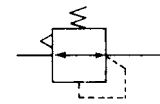

Regulator with
Backflow Function

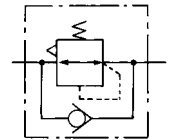

- With the backflow function it incorporates a mechanism to exhaust the air pressure in the outlet side reliably and quickly.

Example 1)

When the pressure in the rear and the front of the cylinder differs:

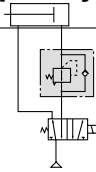

Example 2)

When the air supply is cut off and releasing the inlet pressure to the atmosphere, the residual pressure release of the outlet side can be ensured for a safety purpose.

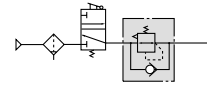

How to Order

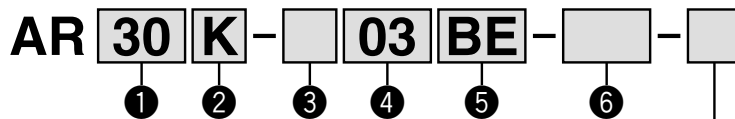

Made to Order

(Refer to pages 354 and 355 for details.)

- Option/Semi-standard: Select one each for a to g.
- Option/Semi-standard symbol: When more than one specification is required, indicate in alphanumeric order.
Example) AR30K-03BE-1NR

		Symbol	Description	①								
				Body size								
				10	20	25	30	40	50	60		
②	With backflow function	Nil	Without backflow function	●	●	●	●	●	●	●		
		K <small>Note 1)</small>	With backflow function	—	●	●	●	●	●	●		
+												
③	Thread type	Nil	Metric thread (M5)	●	—	—	—	—	—	—		
			Rc	—	●	●	●	●	●	●		
		N	NPT	—	●	●	●	●	●	●		
		F	G	—	●	●	●	●	●	●		
+												
④	Port size	M5	M5	●	—	—	—	—	—	—		
		01	1/8	—	●	—	—	—	—	—		
		02	1/4	—	●	●	●	●	—	—		
		03	3/8	—	—	●	●	●	—	—		
		04	1/2	—	—	—	—	●	—	—		
		06	3/4	—	—	—	—	●	●	—		
		10	1	—	—	—	—	—	●	●		
+												
⑤	a	Mounting	Nil	Without mounting option	●	●	●	●	●	●	●	
			B <small>Note 3)</small>	With bracket	●	●	●	●	●	●	●	
			H	With set nut (for panel fitting)	●	●	●	●	●	—	—	
	+											
	b	Pressure gauge	Nil	Without pressure gauge	●	●	●	●	●	●	●	
			E	Square embedded type pressure gauge (with limit indicator)	—	●	●	●	●	●	●	
			G	Round type pressure gauge (without limit indicator)	●	—	—	—	—	—	—	
				Round type pressure gauge (with limit indicator)	—	●	●	●	●	●	●	
		Digital pressure switch	E1 <small>Note 4)</small>	Output: NPN output / Electrical entry: Wiring bottom entry	—	●	●	●	●	●	●	●
			E2 <small>Note 4)</small>	Output: NPN output / Electrical entry: Wiring top entry	—	●	●	●	●	●	●	●
	E3 <small>Note 4)</small>		Output: PNP output / Electrical entry: Wiring bottom entry	—	●	●	●	●	●	●	●	
	E4 <small>Note 4)</small>		Output: PNP output / Electrical entry: Wiring top entry	—	●	●	●	●	●	●	●	

Regulator *Series AR10 to AR60* Regulator with Backflow Function *Series AR20K to AR60K*



AR20, AR20K AR40, AR40K

	Symbol	Description	① Body size									
			10	20	25	30	40	50	60			
⑥ Semi-standard	c	Nil ^{Note 5)}	0.05 to 0.85 MPa setting									
		1 ^{Note 6)}	0.02 to 0.2 MPa setting									
	+											
	d	Nil	Relieving type									
		N	Non-relieving type									
	+											
	e	Nil	Flow direction: Left to right									
		R	Flow direction: Right to left									
	+											
	f	Nil	Downward									
Y		Upward										
+												
g	Nil	Name plate and pressure gauge in imperial units: MPa										
	Z ^{Note 7)}	Name plate and pressure gauge in imperial units: psi										
	ZA ^{Note 8)}	Digital pressure switch: With unit conversion function										
			●	●	●	●	●	●	●	●	●	●
			○ ^{Note 9)}	○ ^{Note 9)}	○ ^{Note 9)}	○ ^{Note 9)}	○ ^{Note 9)}	○ ^{Note 9)}	○ ^{Note 9)}	○ ^{Note 9)}	○ ^{Note 9)}	○ ^{Note 9)}
			—	△ ^{Note 10)}	△ ^{Note 10)}	△ ^{Note 10)}	△ ^{Note 10)}	△ ^{Note 10)}	△ ^{Note 10)}	△ ^{Note 10)}	△ ^{Note 10)}	△ ^{Note 10)}

Note 1) The AR10 type comes with a backflow function as a standard feature. (K is not available.) When using the AR10 type as w/ backflow function, backflow may not occur with the set pressure 0.15 MPa or less. Please set the inlet pressure to at least 0.05 MPa higher than the set pressure.

Note 2) Option B, G, H, M are not assembled and supplied loose at the time of shipment.

Note 3) Assembly of a bracket and set nuts (AR10, AR20(K) to AR40(K))
Including 2 mounting screws for the AR50(K) and AR60(K)

Note 4) When choosing with H (panel mount), the installation space for lead wires will not be secured. In this case, select "wiring top entry" for the electrical entry. (Select "wiring bottom entry" when the semi-standard Y is chosen simultaneously.)

Note 5) Only the AR10 has a pressure setting of 0.05 to 0.7 MPa.

Note 6) The only difference from the standard specifications is the adjusting spring for the regulator. It does not restrict the setting of 0.2 MPa or more. When the pressure gauge is attached, a 0.2 MPa pressure gauge will be fitted.

Note 7) For thread type: M5 and NPT. This product is for overseas use only according to the new Measurement Law. (The SI unit type is provided for use in Japan.) The digital pressure switch will be equipped with the unit conversion function, setting to psi initially.

Note 8) For options: E1, E2, E3, E4. This product is for overseas use only according to the new Measurement Law. (The SI unit is provided for use in Japan.)

Note 9) ○: For thread type: M5 and NPT only

Note 10) △: Select with options: E1, E2, E3, E4.

Standard Specifications

Model	AR10	AR20(K)	AR25(K)	AR30(K)	AR40(K)	AR40(K)-06	AR50(K)	AR60(K)
Port size	M5 x 0.8	1/8, 1/4	1/4, 3/8	1/4, 3/8	1/4, 3/8, 1/2	3/4	3/4, 1	1
Pressure gauge port size ^{Note 1)}	1/16 ^{Note 2)}	1/8		1/4				
Fluid	Air							
Ambient and fluid temperature ^{Note 3)}	-5 to 60°C (with no freezing)							
Proof pressure	1.5 MPa							
Maximum operating pressure	1.0 MPa							
Set pressure range	0.05 to 0.7 MPa	0.05 to 0.85 MPa						
Relief pressure ^{Note 4)}	Set pressure + 0.05 MPa [at relief flow rate of 0.1 ℓ/min (ANR)]							
Construction	Relieving type							
Mass (kg)	0.06	0.26	0.21	0.29	0.44	0.47	1.17	1.22

Note 1) Pressure gauge connection threads are not available for F.R.L. unit with a square embedded type pressure gauge (AR20(K) to AR60(K)).

Note 2) Use a bushing (part no:131368) when connecting the R1/8 pressure gauge to the Rc1/16.

Note 3) -5 to 50°C for the products with the digital pressure switch.

Note 4) Not applicable to the AR10.

Series AR10 to AR60

Series AR20K to AR60K

Options/Part No.

Option		Model	AR10	AR20(K)	AR25(K)	AR30(K)	AR40(K)	AR40(K)-06	AR50(K)	AR60(K)	
Bracket assembly ^{Note 1)}			AR10P-270AS	AR20P-270AS	AR25P-270AS	AR30P-270AS	AR40P-270AS		AR50P-270AS ^{Note 2)}		
Set nut			AR10P-260S	AR20P-260S	AR25P-260S	AR30P-260S	AR40P-260S		___ ^{Note 3)}	___ ^{Note 3)}	
Pressure gauge	^{Note 4)} Round type	Standard	G27-10-R1		G36-10-□01		G46-10-□02				
		0.02 to 0.2 MPa setting	G27-10-R1 ^{Note 5)}		G36-2-□01		G46-2-□02				
	^{Note 4)} Round type (with color zone)	Standard	—		G36-10-□01-L		G46-10-□02-L				
		0.02 to 0.2 MPa setting	—		G36-2-□01-L		G46-2-□02-L				
	^{Note 6)} Square embedded type	Standard	—		GC3-10AS [GC3P-010AS (Pressure gauge cover only)]						
		0.02 to 0.2 MPa setting	—		GC3-2AS [GC3P-010AS (Pressure gauge cover only)]						
Digital pressure switch	NPN output: Wiring bottom entry		—		ISE35-N-25-MLA [ISE35-N-25-M (Switch body only)] ^{Note 7)}						
	NPN output: Wiring top entry				ISE35-R-25-MLA [ISE35-R-25-M (Switch body only)] ^{Note 7)}						
	PNP output: Wiring bottom entry				ISE35-N-65-MLA [ISE35-N-65-M (Switch body only)] ^{Note 7)}						
	PNP output: Wiring top entry				ISE35-R-65-MLA [ISE35-R-65-M (Switch body only)] ^{Note 7)}						

Note 1) Assembly of a bracket and set nuts

Note 2) Assembly of a bracket and 2 mounting screws

Note 3) Please consult with SMC regarding the set nuts for the AR50(K) and AR60(K).

Note 4) □ in part numbers for a round pressure gauge indicates a type of connection thread. No indication is necessary for R; however, indicate N for NPT. Please contact SMC regarding the connection thread NPT and pressure gauge supply for psi unit specifications.

Note 5) Pressure gauge for general purpose

Note 6) Including one O-ring and 2 mounting screws. []: Pressure gauge cover only

Note 7) Lead wire with connector (2 m), adapter, lock pin, O-ring (1 pc.), mounting screw (2 pcs.) are attached. []: Switch body only

Also, regarding how to order the digital pressure switch, please refer to page 388.

⚠ Specific Product Precautions

Be sure to read before handling. Refer to front matters 42 and 43 for Safety Instructions and pages 287 to 291 for F.R.L. Precautions.

Selection

⚠ Warning

- Residual pressure disposal (outlet pressure removal) is not possible for the AR20 to AR60 even though the inlet pressure is exhausted. When the residual pressure disposal is performed, use the regulator with a backflow function (AR20K to AR60K).

Maintenance

⚠ Warning

- When using the regulator with backflow function between a solenoid valve and an actuator, check the pressure gauge periodically. Sudden pressure fluctuations may shorten the durability of the pressure gauge. A digital pressure gauge is recommended for such situation or as deemed necessary.

Mounting and Adjustment

⚠ Warning

- Set the regulator while verifying the displayed values of the inlet and outlet pressure gauges. Turning the regulator knob excessively can cause damage to the internal parts.
- The pressure gauge included with regulators for 0.02 to 0.2 MPa setting is for up to 0.2 MPa use only (except the AR10). Exceeding 0.2 MPa of pressure can damage the gauge.
- Do not use tools on the pressure regulator knob as this may cause damage. It must be operated manually.

⚠ Caution

- Be sure to unlock the knob before adjusting the pressure and lock it after setting the pressure. Failure to follow this procedure can cause damage to the knob and the outlet pressure may fluctuate.
 - Pull the pressure regulator knob to unlock. (You can visually verify this with the "orange mark" that appears in the gap.)
 - Push the pressure regulator knob to lock. When the knob is not easily locked, turn it left and right a little and then push it (when the knob is locked, the "orange mark", i.e., the gap will disappear).

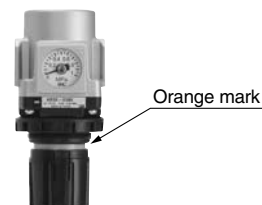

- A knob cover is available to prevent careless operation of the knob. Refer to page 389 for details.

Regulator *Series AR10 to AR60* Regulator with Backflow Function *Series AR20K to AR60K*

Flow Characteristics (Representative values)

Condition: Inlet pressure 0.7 MPa

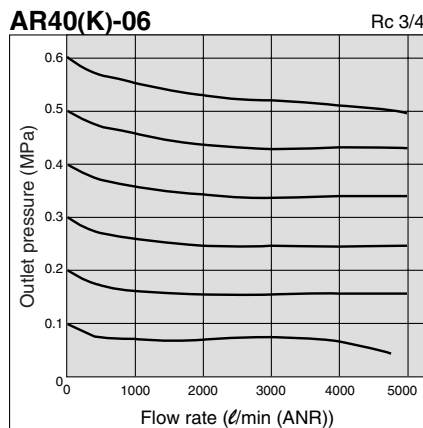
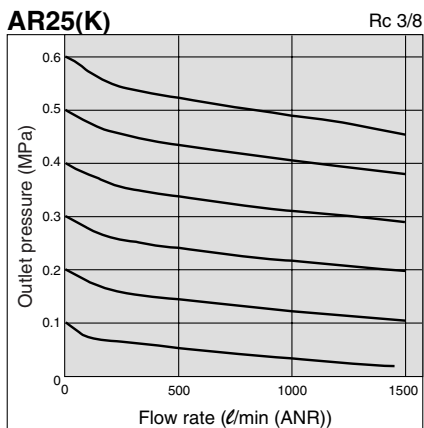
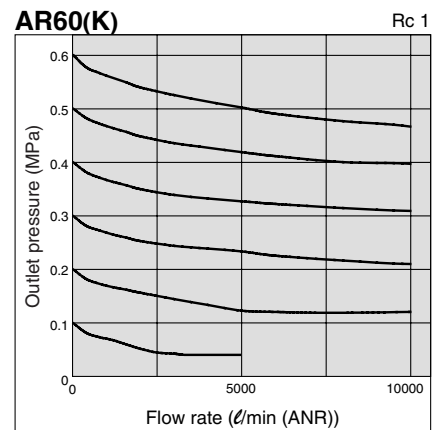
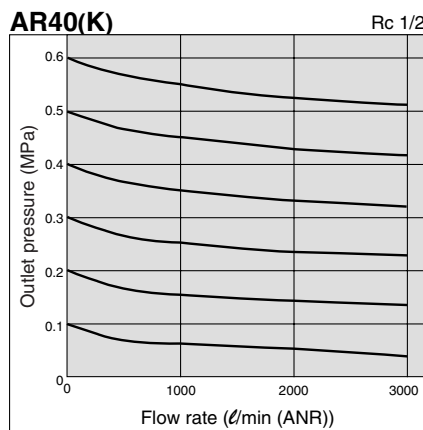
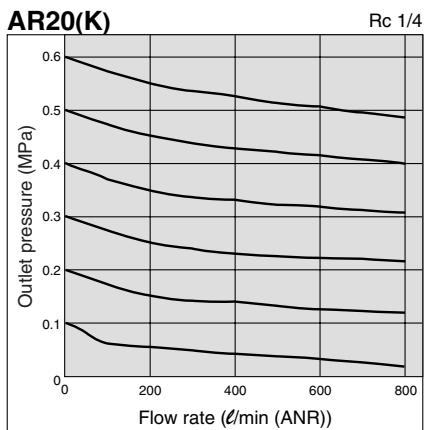
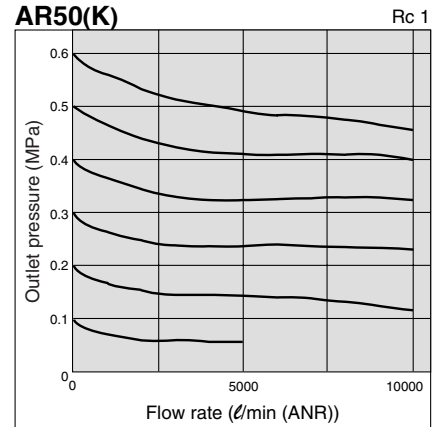
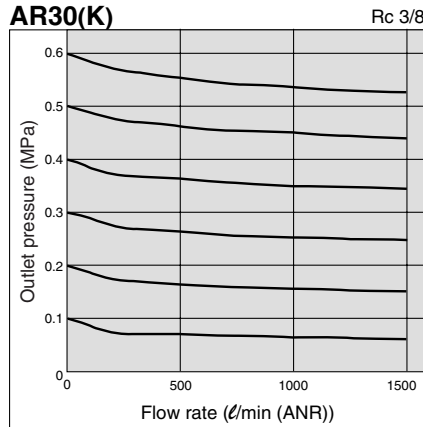
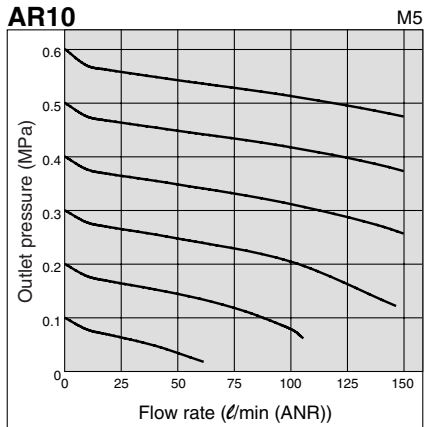

AC

AF□

AR

AL

AW□

A□G

AV

AF800
AF900

Series AR10 to AR60

Series AR20K to AR60K

Pressure Characteristics (Representative values)

Conditions: Inlet pressure 0.7 MPa, Outlet pressure 0.2 MPa, Flow rate 20 l/min (ANR)

AR10

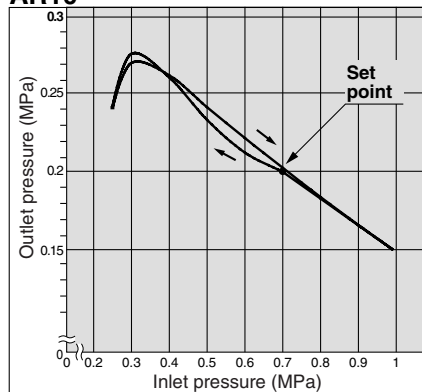

AR30(K)

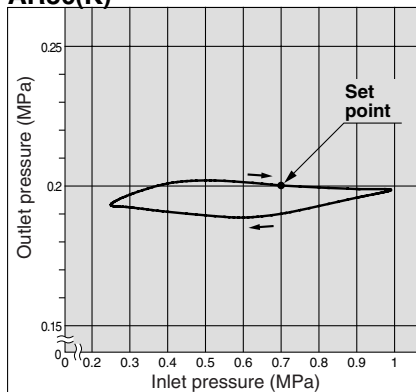

AR50(K)

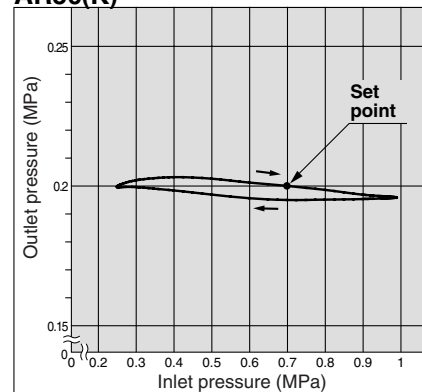

AR20(K)

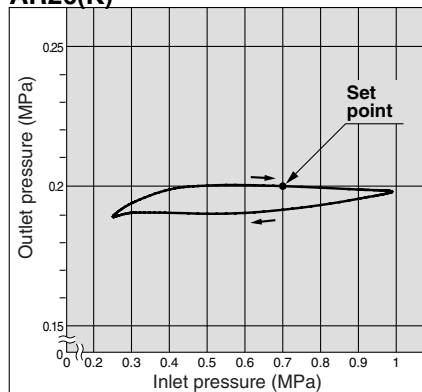

AR40(K)

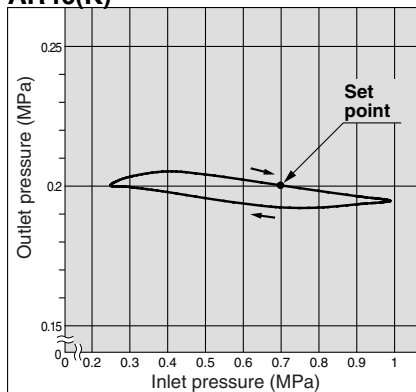

AR60(K)

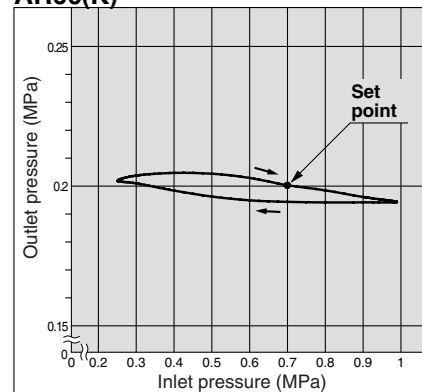

AR25(K)

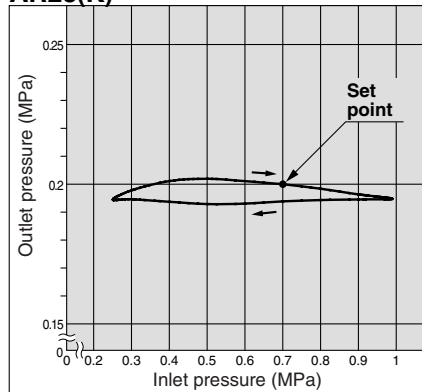

AR40(K)-06

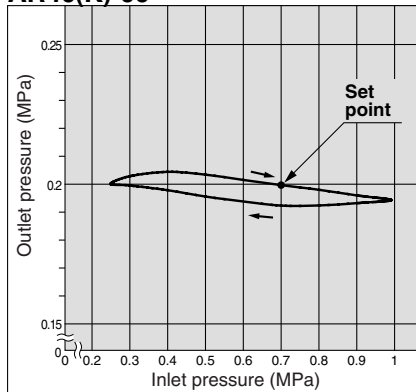

Regulator *Series AR10 to AR60*

Regulator with Backflow Function *Series AR20K to AR60K*

Construction

AR10

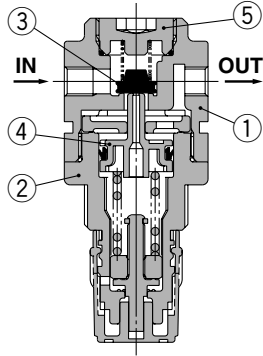

AR20(K), AR25(K)

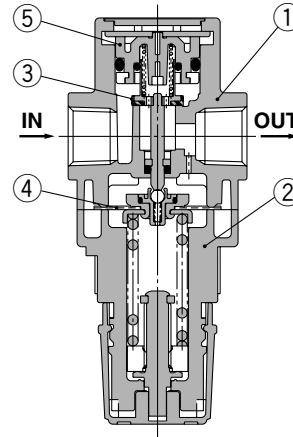

AR30(K), AR40(K)

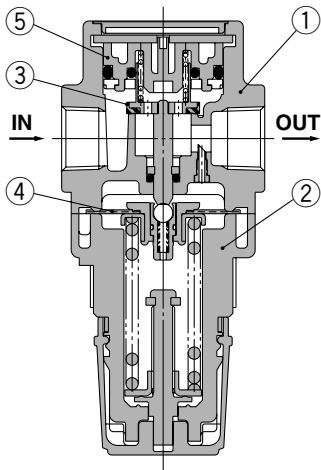

AR50(K), AR60(K)

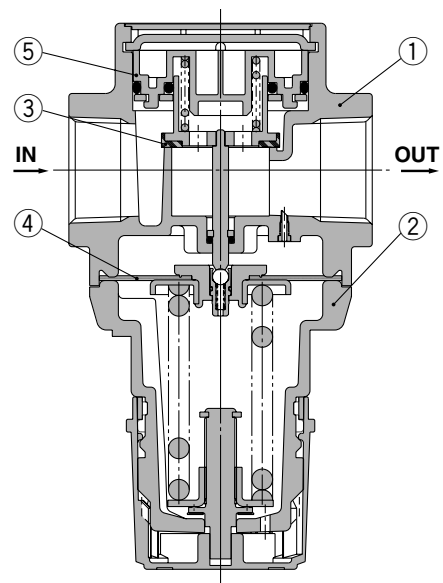

AR20K to AR60K (Regulator with Backflow Function)

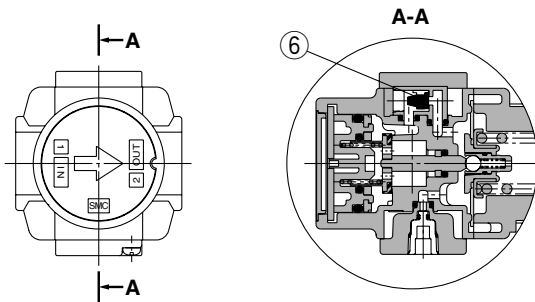

Component Parts

No.	Description	Material	Model	Color
1	Body	Zinc die-cast	AR10, AR20(K)	Platinum silver
		Aluminum die-cast	AR25(K) to AR60(K)	
2	Bonnet	Polyacetal	AR10, AR20(K) to AR40(K)-06	Black
		Aluminum die-cast	AR50(K), AR60(K)	

Replacement Parts

No.	Description	Material	Part no.						
			AR10	AR20(K)	AR25(K)	AR30(K)	AR40(K)	AR40(K)-06	AR50(K)
3	Valve assembly	Brass, HNBR	AR10P-090S	AR20P-410S	AR25P-410S	AR30P-410S	AR40P-410S	AR50P-410S	AR60P-410S
4	Diaphragm assembly	Weatherable NBR	AR10P-150AS <small>Note 1)</small>	AR20P-150AS	AR25P-150AS	AR30P-150AS	AR40P-150AS	AR50P-150AS	
5	Valve guide assembly	Polyacetal	131329	AR20P-050AS	AR25P-050AS	AR30P-050AS	AR40P-050AS	AR50P-050AS	AR60P-050AS
6	Check valve assembly <small>Note 2)</small>	—	—	AR20KP-020AS					

Note 1) The AR10 is a piston type. Assembly of a piston and a seal (KSYP-13).
 Note 2) Check valve assembly is applicable for a regulator with backflow function (AR20K to AR60K) only.
 Assembly of a check valve cover, check valve body assembly and 2 screws

AC
 AF□
AR
 AL
 AW□
 A□G
AV
 AF800
 AF900

Series AR10 to AR60

Series AR20K to AR60K

Working Principle (Regulator with Backflow Function)

AR10

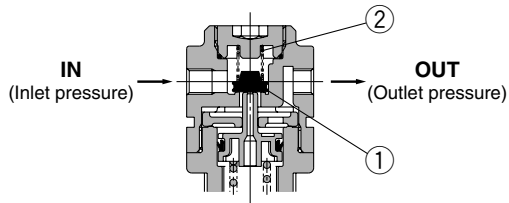

Figure 1

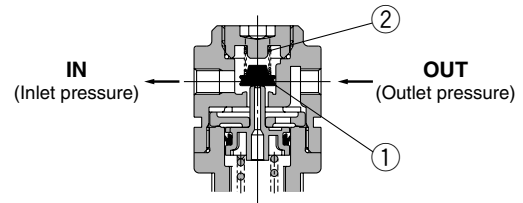

Figure 2

When the inlet pressure is higher than the regulating pressure, the check valve operates as a normal regulator (Figure 1).

When the inlet pressure is shut off and exhausted, any inlet pressure applied to the valve ① will be lost. The force for seating the valve ① is the valve spring force ② only. When the valve ① is opened using the outlet force, the outlet pressure will be exhausted at the inlet side. (Figure 2)

When the set pressure is 0.15 MPa or less, valve ① may not open due to the valve spring ② force.

AR20K to AR60K

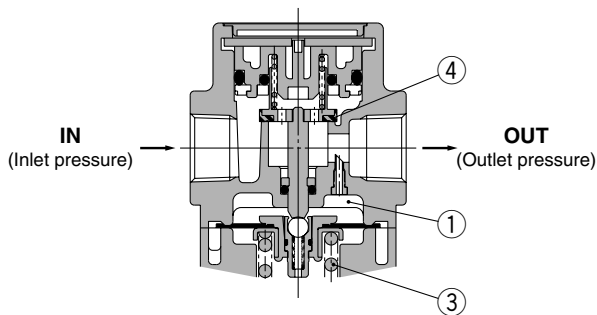
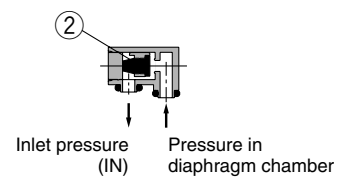
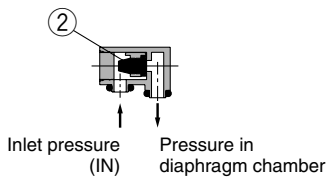
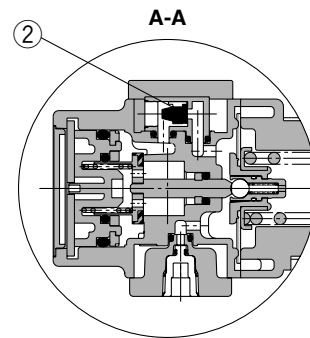
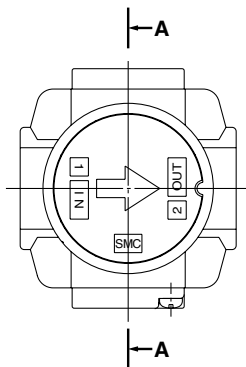

Figure 1 Normal

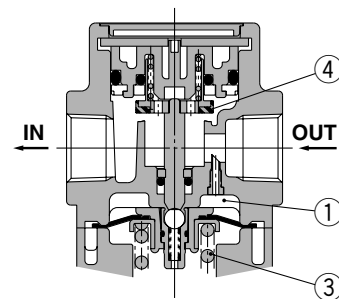

Figure 2 Backflow

When the inlet pressure is higher than the regulating pressure, the check valve ② closes and operates as a normal regulator (Figure 1). When the inlet pressure is shut off and released, the check valve ② opens and the pressure in the diaphragm chamber ① is released into the inlet side (Figure 2).

This lowers the pressure in the diaphragm chamber ① and the force generated by the pressure regulator spring ③ lifts the diaphragm. Valve ④ opens through the stem, and the outlet pressure is released to the inlet side (Figure 2).

Regulator *Series AR10 to AR60*

Regulator with Backflow Function *Series AR20K to AR60K*

Dimensions

AR10, AR20(K) to AR40(K)-06

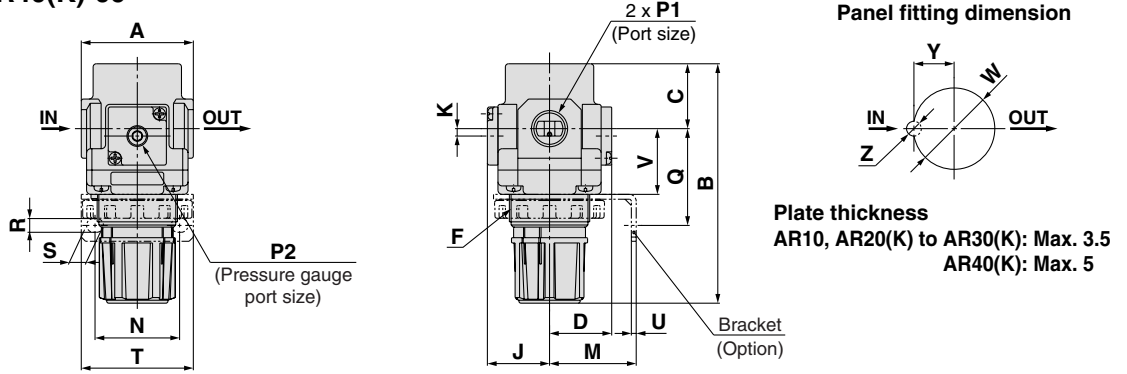

AR50(K), AR60(K)

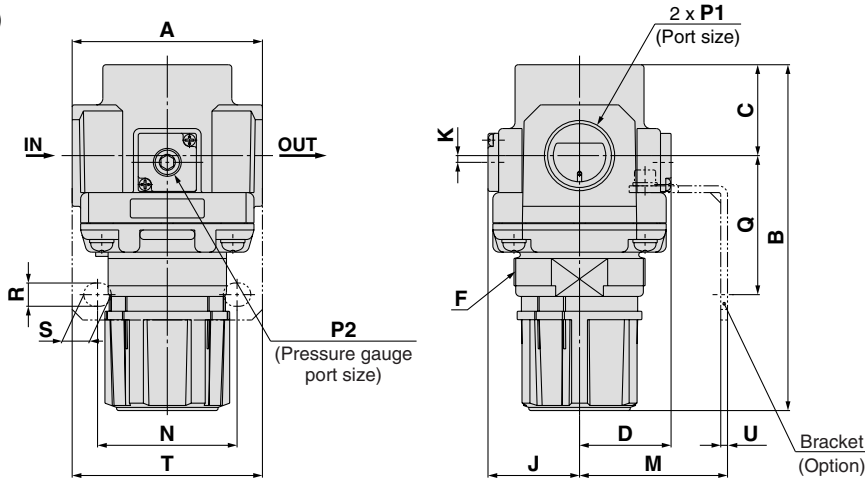

Applicable model	AR20(K) to AR60(K)		AR10, AR20(K) to AR60(K)	AR20(K) to AR60(K)
Option	Square embedded type pressure gauge	Digital pressure switch	Round type pressure gauge	Round type pressure gauge (with color zone)
Dimensions				

Model	Standard specifications										Optional specifications						
	P1	P2	A	B ^{Note 1)}	C	D	F	J	K	H	J	H	J	H	J	H	J
AR10	M5 x 0.8	1/16	25	58	11	12.5	M18 x 1	13	0	—	—	—	—	ø26	26	—	—
AR20(K)	1/8, 1/4	1/8	40	94	26.5	28.5	M28 x 1	28.5	2 ^{Note 2)}	□28	29.5	□27.8	40	ø37.5	65	ø37.5	65
AR25(K)	1/4, 3/8	1/8	53	101	28	27.5	M32 x 1.5	27.5	0	□28	28.5	□27.8	39	ø37.5	64	ø37.5	64
AR30(K)	1/4, 3/8	1/8	53	116	31	29.5	M38 x 1.5	29.5	3.5	□28	30.5	□27.8	41	ø37.5	66	ø37.5	66
AR40(K)	1/4, 3/8, 1/2	1/4	70	128	36	34	M42 x 1.5	34	3.5	□28	35	□27.8	45	ø42.5	74	ø42.5	74
AR40(K)-06	3/4	1/4	75	129	36	34	M42 x 1.5	34	3	□28	35	□27.8	45	ø42.5	74	ø42.5	74
AR50(K)	3/4, 1	1/4	90	169	43	43.5	M62 x 1.5	43.5	3.3	□28	44.5	□27.8	55	ø42.5	84	ø42.5	84
AR60(K)	1	1/4	95	176	46	43.5	M62 x 1.5	43.5	3.3	□28	44.5	□27.8	55	ø42.5	84	ø42.5	84

Model	Optional specifications														
	Bracket mount								Panel mount						
	M	N	Q	R	S	T	U	V	W	Y	Z				
AR10	25	28	30	4.5	6.5	40	2	18	18.5	—	—				
AR20(K)	30	34	44	5.4	15.4	55	2.3	25	28.5	14	6				
AR25(K)	30	34	44	5.4	15.4	55	2.3	26	32.5	16	6				
AR30(K)	41	40	46	6.5	8	53	2.3	31	38.5	19	7				
AR40(K)	50	54	54	8.5	10.5	70	2.3	35.5	42.5	21	7				
AR40(K)-06	50	54	56	8.5	10.5	70	2.3	37	42.5	21	7				
AR50(K)	70	66	65.8	11	13	90	3.2	—	—	—	—				
AR60(K)	70	66	65.8	11	13	90	3.2	—	—	—	—				

Note 1) The total length of B dimension is the length when the filter regulator knob is unlocked.
 Note 2) For the AR20 only, the position of the pressure gauge is above the center of the piping.

- AC
- AF□
- AR
- AL
- AW□
- A□G
- AV
- AF800
- AF900

Regulator AR20 to AR60

Made to Order Specifications:

Please contact SMC for detailed dimensions, specifications, and lead times.



AR30-03-X425

① Special Temperature Environment

Special materials are used in the manufacturing of seals and resin parts to allow them to withstand various temperature conditions in cold or tropical (hot) climates.

Specifications

Made-to-order part no.	-X430	-X440
Environment	Low temperature	High temperature
Ambient temperature (°C)	-30 to 60	-5 to 80
Fluid temperature (°C)	-5 to 60 (with no freezing)	
Material	Rubber parts	Special NBR
	Main parts	FKM
	Metal (Aluminum die-cast), etc.	

Applicable Model

Model	AR25	AR30	AR40	AR40-06	AR50	AR60
Port size	1/4, 3/8	1/4, 3/8	1/4, 3/8, 1/2	3/4	3/4, 1	1

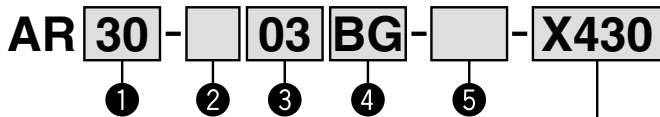

- Option/Semi-standard: Select one each for a to g.
- Option/Semi-standard symbol: When more than one specification is required, indicate in alphanumeric order.
Example) AR30-03BG-1NR-X430

For high/low temperature

X430	Low temperature
X440	High temperature

	Symbol	Description	① Body size					
			25	30	40	50	60	
② Thread type	Nil	Rc	●	●	●	●	●	
	N	NPT	●	●	●	●	●	
	F	G	●	●	●	●	●	
+								
③ Port size	02	1/4	●	●	●	—	—	
	03	3/8	●	●	●	—	—	
	04	1/2	—	—	●	—	—	
	06	3/4	—	—	●	●	—	
	10	1	—	—	—	●	●	
+								
④ Option	a Mounting	Nil	Without mounting option	●	●	●	●	●
		B	With bracket	●	●	●	●	●
		H	With set nut (for panel fitting)	●	●	●	—	—
+								
④ Option	b Pressure gauge	G	Round type pressure gauge (without limit indicator)	●	●	●	●	●
		G	Round type pressure switch (with limit indicator)	●	●	●	●	●
+								
⑤ Semi-standard	c Set pressure	Nil	0.05 to 0.85 MPa setting	●	●	●	●	●
		1	0.02 to 0.2 MPa setting	●	●	●	●	●
+								
⑤ Semi-standard	d Exhaust mechanism	Nil	Relieving type	●	●	●	●	●
		N	Non-relieving type	●	●	●	●	●
+								
⑤ Semi-standard	e Flow direction	Nil	Flow direction: Left to right	●	●	●	●	●
		R	Flow direction: Right to left	●	●	●	●	●
+								
⑤ Semi-standard	f Knob	Nil	Downward	●	●	●	●	●
		Y	Upward	●	●	●	●	●
+								
⑤ Semi-standard	g Pressure unit	Nil	Name plate and pressure gauge in imperial units: MPa	●	●	●	●	●
		Z	Name plate and caution plate for bowl in imperial units: psi	○	○	○	○	○

- Note 1) Option B, G, H are not assembled and supplied loose at the time of shipment.
 Note 2) Assembly of a bracket and set nuts (AR25 to AR40) Including 2 mounting screws for the AR50 and AR60
 Note 3) Mounting thread for pressure gauge: 1/8 for the AR25 to AR30; 1/4 for the AR40 to AR60. Pressure gauge type: G43
 Note 4) The only difference from the standard specifications is the adjusting spring for the regulator. It does not restrict the setting of 0.2 MPa or more. When the pressure gauge is attached, a 0.2 MPa pressure gauge will be fitted.
 Note 5) For thread type: NPT. This product is for overseas use only according to the new Measurement Law. (The SI unit type is provided for use in Japan.)
 Note 6) ○: For thread type: NPT only

② High Pressure

Strong materials are used in the manufacturing of air filters intended for high pressure operation. Also, construction modification allows a wider regulating pressure range.

Specifications

Made-to-order part no.	-X425
Proof pressure (MPa)	3.0
Maximum operating pressure (MPa)	2.0
Set pressure range (MPa)	0.1 to 1.6
Ambient and fluid temperature (°C)	-5 to 60 (with no freezing)

Applicable Model

Model	AR20	AR25	AR30	AR40	AR40-06	AR50	AR60
Port size	1/8, 1/4	1/4, 3/8	1/4, 3/8	1/4, 3/8, 1/2	3/4	3/4, 1	1

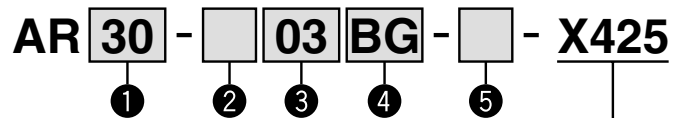

- Option/Semi-standard: Select one each for a to f.
- Option/Semi-standard symbol: When more than one specification is required, indicate in alphabetic order.
Example) AR30-03BG-NR-X425

	Symbol	Description	① Body size					
			20	25	30	40	50	60
② Thread type	Nil	Rc	●	●	●	●	●	
	N	NPT	●	●	●	●	●	
	F	G	●	●	●	●	●	
+								
③ Port size	01	1/8	●	—	—	—	—	
	02	1/4	●	●	●	—	—	
	03	3/8	—	●	●	—	—	
	04	1/2	—	—	●	—	—	
	06	3/4	—	—	—	●	—	
+								
④ Option	a Mounting	Nil	Without mounting option	●	●	●	●	●
		B	With bracket	●	●	●	●	●
		H	With set nut (for panel fitting)	●	●	●	—	—
+								
④ Option	b Pressure gauge	G	Round type pressure switch (with limit indicator)	●	●	●	●	●
		G	Round type pressure switch (with limit indicator)	●	●	●	●	●
+								
⑤ Semi-standard	c Exhaust mechanism	Nil	Relieving type	●	●	●	●	●
		N	Non-relieving type	●	●	●	●	●
+								
⑤ Semi-standard	d Flow direction	Nil	Flow direction: Left to right	●	●	●	●	●
		R	Flow direction: Right to left	●	●	●	●	●
+								
⑤ Semi-standard	e Knob	Nil	Downward	●	●	●	●	●
		Y	Upward	●	●	●	●	●
+								
⑤ Semi-standard	f Pressure unit	Nil	Name plate and pressure gauge in imperial units: MPa	●	●	●	●	●
		Z	Name plate and caution plate for bowl in imperial units: psi	○	○	○	○	○

- Note 1) Option B, G, H are not assembled and supplied loose at the time of shipment.
 Note 2) Assembly of a bracket and set nuts (AR20 to AR40) Including 2 mounting screws for the AR50 and AR60
 Note 3) Mounting thread for pressure gauge: 1/8 for AR20 to AR30, 1/4 for AR40 to AR60. Pressure gauge type: G46-20-□
 Note 4) For thread type: NPT. This product is for overseas use only according to the new Measurement Law. (The SI unit type is provided for use in Japan.)
 Note 5) ○: For thread type: NPT only

Regulator AR10 to AR60

Regulator with Backflow Function AR20K to AR60K

Made to Order Specifications:



Please contact SMC for detailed dimensions, specifications, and lead times.

③ 0.4 MPa Setting

The maximum set pressure is 0.4 MPa. When a pressure gauge is included, the display will show a range from 0 to 0.4 MPa.

Specifications

Proof pressure	1.5 MPa
Maximum operating pressure	1.0 MPa
Set pressure range	0.05 to 0.4 MPa

Applicable Model

Model	AR10	AR20(K)	AR25(K)	AR30(K)	AR40(K)	AR40(K)-06	AR50(K)	AR60(K)
Port size	M5	1/8, 1/4	1/4, 3/8	1/4, 3/8	1/4, 3/8, 1/2	3/4	3/4, 1	1

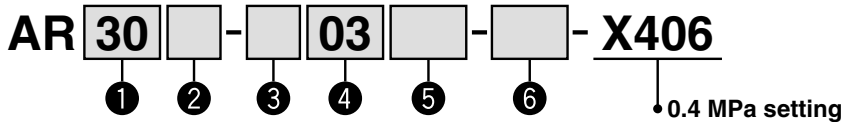

- Option/Semi-standard: Select one each for a to f.
- Option/Semi-standard symbol: When more than one specification is required, indicate in alphabetic order.
Example) AR30K-03BE-NR-X406

		Symbol	Description	① Body size							
				10	20	25	30	40	50	60	
②	With backflow function	Nil	Without backflow function	●	●	●	●	●	●	●	
		K <small>Note 1)</small>	With backflow function	—	●	●	●	●	●	●	
		+									
③	Thread type	Nil	Metric thread (M5)	●	—	—	—	—	—	—	
		Rc		—	●	●	●	●	●	●	
		N	NPT	—	●	●	●	●	●	●	
		F	G	—	●	●	●	●	●	●	
		+									
④	Port size	M5	M5	●	—	—	—	—	—	—	
		01	1/8	—	●	—	—	—	—	—	
		02	1/4	—	—	●	—	—	—	—	
		03	3/8	—	—	●	●	—	—	—	
		04	1/2	—	—	—	—	●	—	—	
		06	3/4	—	—	—	—	—	●	—	
		10	1	—	—	—	—	—	—	●	
		+									
⑤	a	Mounting	Nil	Without mounting option	●	●	●	●	●	●	●
			B <small>Note 3)</small>	With bracket	●	●	●	●	●	●	●
			H	With set nut (for panel fitting)	●	●	●	●	●	—	—
			+								
	b	Pressure gauge	Nil	Without pressure gauge	●	●	●	●	●	●	●
			E	Square embedded type pressure gauge (with limit indicator)	—	●	●	●	●	●	●
			G	Round type pressure gauge (without limit indicator)	●	—	—	—	—	—	—
			M	Round type pressure gauge (with limit indicator)	—	●	●	●	●	●	●
			M	Round type pressure gauge (with color zone)	—	●	●	●	●	●	●
	Digital pressure switch	E1 <small>Note 4)</small>	Output: NPN output / Electrical entry: Wiring bottom entry	—	●	●	●	●	●	●	●
		E2 <small>Note 4)</small>	Output: NPN output / Electrical entry: Wiring top entry	—	●	●	●	●	●	●	●
		E3 <small>Note 4)</small>	Output: PNP output / Electrical entry: Wiring bottom entry	—	●	●	●	●	●	●	●
		E4 <small>Note 4)</small>	Output: PNP output / Electrical entry: Wiring top entry	—	●	●	●	●	●	●	●
		+									
c	Exhaust mechanism	Nil	Relieving type	●	●	●	●	●	●	●	
		N	Non-relieving type	●	●	●	●	●	●	●	
		+									
d	Flow direction	Nil	Flow direction: Left to right	●	●	●	●	●	●	●	
		R	Flow direction: Right to left	●	●	●	●	●	●	●	
		+									
e	Knob	Nil	Downward	●	●	●	●	●	●	●	
		Y	Upward	●	●	●	●	●	●	●	
		+									
f	Pressure unit	Nil	Name plate and pressure gauge in imperial units: MPa	●	●	●	●	●	●	●	
		Z <small>Note 5)</small>	Name plate and pressure gauge in imperial units: psi	○ <small>Note 7)</small>	○ <small>Note 7)</small>	○ <small>Note 7)</small>	○ <small>Note 7)</small>	○ <small>Note 7)</small>	○ <small>Note 7)</small>	○ <small>Note 7)</small>	
		ZA <small>Note 6)</small>	Digital pressure switch: With unit switching function	—	△ <small>Note 8)</small>	△ <small>Note 8)</small>	△ <small>Note 8)</small>	△ <small>Note 8)</small>	△ <small>Note 8)</small>	△ <small>Note 8)</small>	

- Note 1) The AR10 type comes with a backflow function as a standard feature. (K is not available.) When using the AR10 type as w/ backflow function, backflow may not occur with the set pressure 0.15 MPa or less. Please set the inlet pressure to at least 0.05 MPa higher than the set pressure.
- Note 2) Option B, G, H are not assembled and supplied loose at the time of shipment.
- Note 3) Assembly of a bracket and set nuts (AR10, AR20(K) to AR40(K)) Including 2 mounting screws for the AR50(K), AR60(K)
- Note 4) When choosing with H (panel mount), the installation space for lead wires will not be secured. In this case, select "wiring top entry" for the electrical entry.

- (Select "wiring bottom entry" when the semi-standard Y is chosen simultaneously.)
- Note 5) For thread type: M5 and NPT. This product is for overseas use only according to the new Measurement Law. (The SI unit type is provided for use in Japan.) The digital pressure switch will be equipped with the unit conversion function, setting to psi initially.
- Note 6) For options: E1, E2, E3, E4. This product is for overseas use only according to the new Measurement Law. (The SI unit is provided for use in Japan.)
- Note 7) ○: For thread type: M5 and NPT only
- Note 8) △: Select with options: E1, E2, E3, E4.

- AC
- AF□
- AR
- AL
- AW□
- A□G
- AV
- AF800
- AF900