

Solenoid valves MH2/MH3/MH4, fast-switching valves

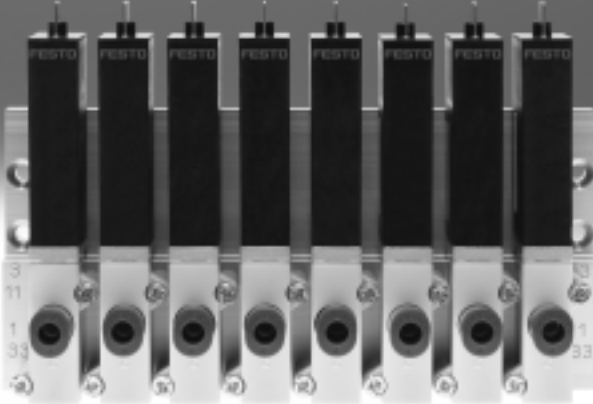

## Fast-switching valves from Festo: it's not just the switching that's fast

### The fast-switching professionals with response times down to 2 milliseconds

Speed, dynamic response and precision are in demand more than ever in modern automation. The solution lies in pneumatic components. The result: shorter cycle times in return for comparatively low investment costs for the components. Maximum process reliability, sturdiness and service life are guaranteed.

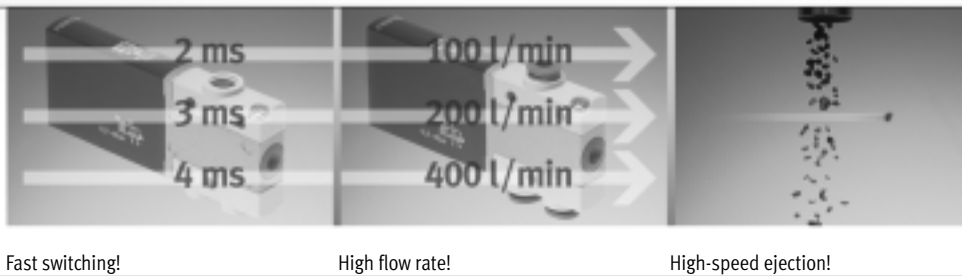

### High speed in production

Fast-switching valves are a true technological gem when it comes to high-speed applications. With response times  $\leq 2$  ms and a repetition accuracy  $\leq 0.2$  ms, they represent the pinnacle of what is technologically achievable worldwide – even in 24-hour continuous operation with over 500 million cycles.

Fast-switching valves are easy to retrofit into existing systems or can be used as a pacesetter for newly designed systems. They have a compact design that provides high component density. Indispensable for sorting parts using an air ejector, in flap control systems, for gluing, dispensing, packaging and, of course, also suitable for pick & place vacuum applications, for example (continuous holding not possible).

### Faster switching

The extremely short response times facilitate short cycle times. Extremely precise switching makes it possible to control the timing of process sequences accurately.

High output and very good machine utilisation are also guaranteed. Excellent repetition accuracy of response times ensures consistent processes, improves process and part quality and reduces rejects and rework.

### Faster installation

Thanks to the various connection options such as threads or integrated tubing push-in connectors and the different mounting options for individual valves or manifold assembly, the installation can be optimised to suit local conditions and space requirements can be reduced to a minimum. Fast-switching valves can be used directly in the application without additional protective measures. As a result, very short pneumatic lines offer short signal paths and fast response times.

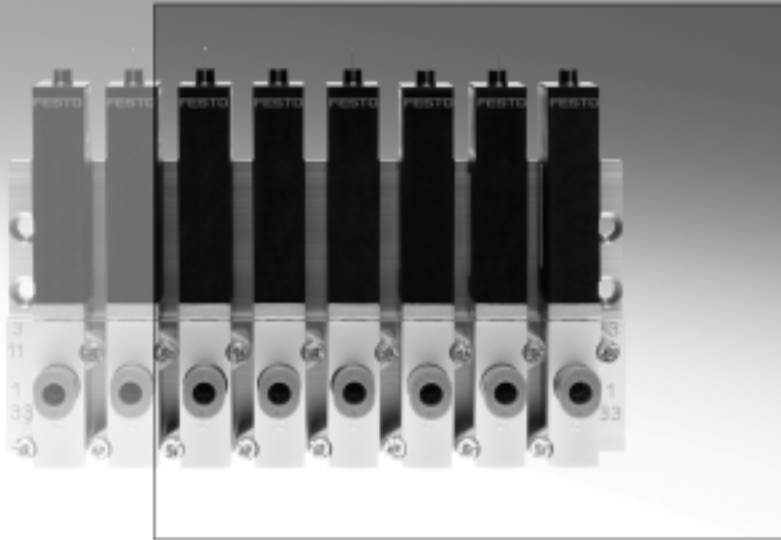

- Variants with and without fast-switching electronics as 3/2-way and 5/2-way valves
- Shortest possible response times with maximum repetition accuracy and outstanding service life
- Directly actuated poppet valve with degree of protection IP65

#### Advantages for designers

- Very high cycle rates
- Extremely short cycle times
- Maximum repetition accuracy
- Vacuum-compatible thanks to directly actuated poppet valve (time-restricted)
- Flexible design principle
- Direct activation via standard PLC possible
- Direct mounting in the application with degree of protection IP65

#### Advantages for purchasers

- Everything from a single source
- Low ordering costs
- No additional mounting components
- No costs for additional power outputs
- Use of standard PLCs
- Increased system productivity

#### Advantages for installation

- Easy installation
- Direct pneumatic connection via integrated tubing connections
- Reduced assembly costs with pre-assembled cables
- No additional protection required thanks to IP65



## Fast and precise – sturdy and economical

### High performance, process stability and extremely easy handling

MH fast-switching valves increase cycle rates and improve process and part quality with their excellent repetition accuracy.

2 ms, 100 l/min, IP 65



Accurate high-performance switching ...

... for fast and precision-pulsed operation

#### Integrated: the fast-switching electronics

- All 3/2- and 5/2-way valves are available with built-in fast-switching electronics
- This enables a constant dynamic response independent of temperature or supply voltage fluctuations
- With Festo plug & work, installation is easy, and no additional electronics or pneumatics know-how is necessary

#### Optimised: systems and processes

- On-site assembly thanks to IP65 – insensitive to dust and humidity
- Direct activation with 24 V DC/1 A – use of PLC standard outputs
- With an extremely long service life of 500 million cycles, and continuous three-shift operation with no need for maintenance, optimum efficiency comes as standard!

#### Key features

- Repetition accuracy  $\leq 0.2$  ms for accurate dispensing/bonding, for example
- Response time  $\leq 3$  ms for short cycle times and very quick response characteristics
- 10 mm width enables compact assembly
- Can be connected as an individual valve, semi in-line or sub-base variant, allowing for need-optimised installation
- Degree of protection IP65 enables direct mounting in the application without additional safeguarding
- Easy installation via direct activation from the standard PLC with 24 V DC/1 A

### Fast valves and an optimised control chain – two guarantees for success

To generate speed in pneumatics, the combination of valve and cylinder must be perfectly harmonised. With the right combination, efficiency can be improved by 30%. Cylinders with small diameters and short strokes need fast valves.

#### Short-stroke cylinder ADN-32-5 – 30% faster with a fast-switching valve

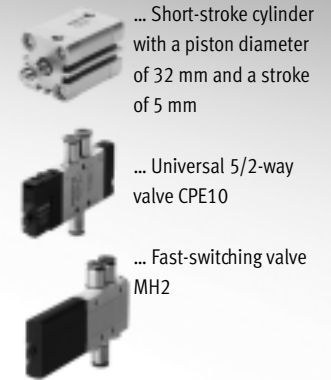
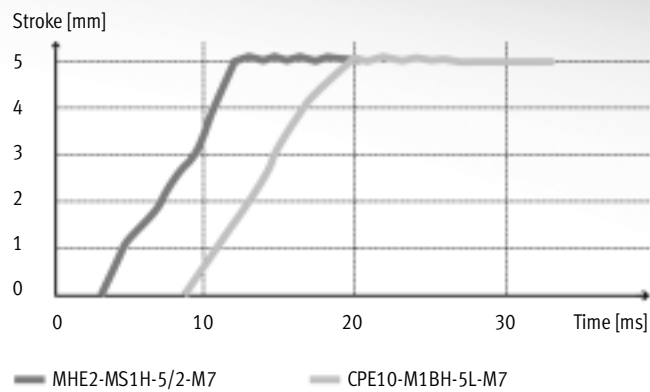

Valve type		CPE10	MH2-5/2
Flow rate	[l/min]	350	100
Valve response time	[ms]	16	1.7
Cycle time	[ms]	20	14
	[%]	100	70
Result			30% faster

#### Small and fast – a good combination

With a small cylinder volume, particularly in the case of short-stroke cylinders, the response time is crucial. In the example shown here, the combination with a fast-switching valve is 30% faster. In concrete terms, this means that a cylinder activated using a fast-switching valve is already in the end position before the cylinder in combination with a universal valve even begins to move.

This generates a significant increase in both the efficiency and the economy of the system – not forgetting that the two valves have comparable space requirements and weight, and the fast-switching valve uses less air and lasts 10 times as long!

#### Length means losses – Focus on tubing

Short tubing is a key factor when it comes to pneumatic efficiency. Reducing the tubing length from 1 m to 0.5 m, for example, improves the max. possible flow rate by 20%. A tube length greater than 2 m results in losses of up to 50%. Use of the next largest tube is recommended in this case.

#### Small and local – The clever alternative

Short tubing with a small diameter is ideal for mounting of valves close to the cylinder. The small and light fast-switching valves are suitable for direct mounting in the application – thanks also to their degree of protection IP65. By using them together with smaller and lighter fittings, the weight is reduced, too – resulting in an improvement in the efficiency of moving systems, in particular.

# Solenoid valves MH2, fast-switching valves

Product range overview



Function	Circuit symbol	Design	Switching time [ms]				Operating voltage [V DC]	Free of copper and PTFE	→ Page/ Internet
			Off <sup>2)</sup>	On <sup>2)</sup>	Off	On			
3/2-way valve <sup>1)</sup>	<b>Standard nominal flow rate 100 l/min</b>								
		Individual valve	2	1.7	3.5	7	24	■	10
		Semi in-line valve	2	1.7	3.5	7	24	■	23
		Sub-base valve	2	1.7	3.5	7	24	■	40

- 1) Can be used as a 2/2-way valve by sealing port 3 or 33  
 2) With integrated fast-switching electronics

Function	Circuit symbol	Design	Switching time [ms]		Operating voltage [V DC]	Free of copper and PTFE	→ Page/ Internet
			Off	On			
5/2-way valve	<b>Standard nominal flow rate 100 l/min</b>						
		Individual valve	1.7	1.9	24	■	17
		Semi in-line valve	1.7	1.9	24	■	32
Sub-base valve		1.7	1.9	24	■	49	

Mounting options							
Design	Individual valve		Semi in-line valve		Sub-base valve		
Valve function	3/2-way	5/2-way	3/2-way	5/2-way	3/2-way	5/2-way	
<b>Plug vane</b>							
	Direct mounting	■	■	-	-	-	-
	Individual sub-base	-	-	■	■	■	■
	Manifold assembly	-	-	■	■	■	■
<b>Moulded-in cable</b>							
	Direct mounting	■	■	-	-	-	-
	Individual sub-base	-	-	-	-	■	■
	Manifold assembly	-	-	-	-	■	■

# Solenoid valves MH3, fast-switching valves

Product range overview

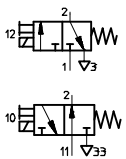
Function	Circuit symbol	Design	Switching time [ms]				Operating voltage [V DC]	Free of copper and PTFE	→ Page/ Internet
			Off <sup>2)</sup>	On <sup>2)</sup>	Off	On			
3/2-way valve <sup>1)</sup>	Standard nominal flow rate 200 l/min								
		Individual valve	2.8	2.3	4.5	8.3	24	■	58
		Semi in-line valve	2.8	2.3	4.5	8.3	24	■	65
Sub-base valve		2.8	2.3	4.5	8.3	24	■	74	

1) Can be used as a 2/2-way valve by sealing port 3 or 33

2) With integrated fast-switching electronics

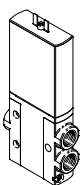
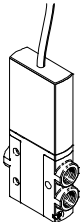
Mounting options				
Design	Individual valve	Semi in-line valve	Sub-base valve	
Plug vane				
	Direct mounting	■	-	-
	Individual sub-base	-	■	■
	Manifold assembly	-	■	■
Moulded-in cable				
	Direct mounting	■	-	-
	Individual sub-base	-	■	■
	Manifold assembly	-	■	■

# Solenoid valves MH4, fast-switching valves

Product range overview

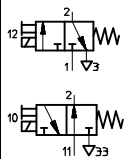
Function	Circuit symbol	Design	Switching time [ms]				Operating voltage [V DC]	Free of copper and PTFE	→ Page/ Internet
			Off <sup>2)</sup>	On <sup>2)</sup>	Off	On			
3/2-way valve <sup>1)</sup>		<b>Standard nominal flow rate 400 l/min</b>							
		Individual valve	3.5	3.5	5	10.5	24	■	84
		Semi in-line valve	3.5	3.5	5	10.5	24	■	89
		Sub-base valve	3.5	3.5	5	10.5	24	■	98

- 1) Can be used as a 2/2-way valve by sealing port 3 or 33
- 2) With integrated fast-switching electronics

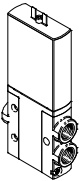
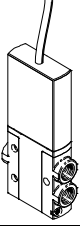
Mounting options				
Design		Individual valve	Semi in-line valve	Sub-base valve
<b>Plug vane</b>				
	Direct mounting	■	-	-
	Individual sub-base	-	■	■
	Manifold assembly	-	■	■
<b>Moulded-in cable</b>				
	Direct mounting	■	-	-
	Individual sub-base	-	■	■
	Manifold assembly	-	■	■



# Solenoid valves MH2, fast-switching valves

Type codes

MH E 2 - M S 1 H - 3/2 - 0 - M7 - K

**Valve series**

MH	Fast-switching valves
----	-----------------------

**Design**

E	Individual valve
P	Semi in-line valve
A	Sub-base valve

**Size**

2	Flow rates 90 to 100 l/min
---	----------------------------

**Drive system**

M	Solenoid, switching
---	---------------------

**Switching time**

-	7 ms
S	2 ms

**Operating voltage**

1	24 V DC
---	---------

**Manual override**

H	Non-detenting
---	---------------

**Valve function**

3/2	3/2-way valve
5/2	5/2-way valve

**Normal position**

-	5/2-way valve
G	Closed
0	Open

**Pneumatic connection**

2	Sub-base, nominal width 2 mm
M5	Thread M5
M7	Thread M7
QS-4	Push-in connector For tubing O.D. 4 mm

**Electrical connection**

-	Plug vanes with connection pattern ZC
K	Moulded-in cable, 2.5 m long

# Solenoid valves MHE2, fast-switching valves

Peripherals overview – Individual valve, 3/2-way valve

## Connection with plug vanes – Connection with moulded-in cable

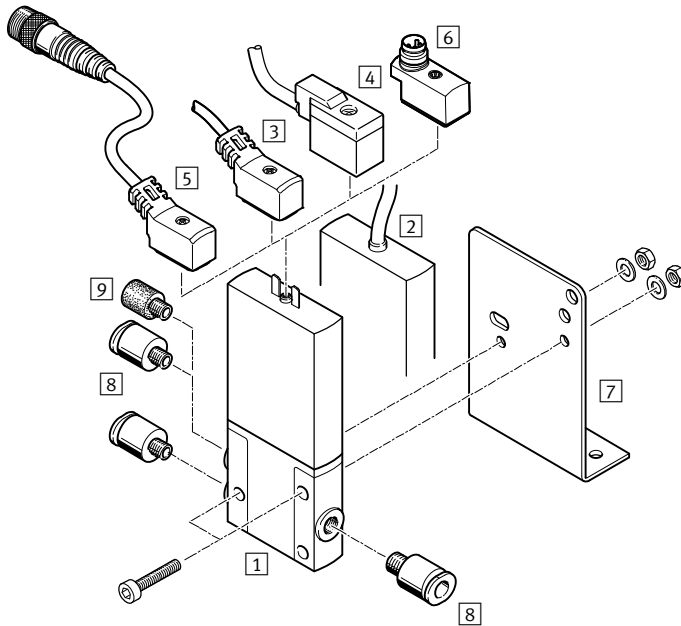





Designation	Brief description	→ Page/Internet
1 Individual valve MHE2	With plug vanes	15
2 Individual valve MHE2-...-K	With moulded-in cable, IP65	15
3 Connecting cable NEBV	PUR cable, signal status display with LED, IP65	16
4 Plug socket with cable KMYZ-4	PVC cable, without signal status display, IP50	16
5 Connecting cable NEBV	PUR cable, signal status display with LED, plug M8x1 3-pin, IP65	16
6 Adapter VAVE-C8	For connecting the valves via connecting cable M8 3-pin or 4-pin, IP65	16
7 Mounting bracket MHE2-BG-L	For wall mounting	16
8 Push-in fittings QS	For connecting compressed air tubing with standard O.D.	16
9 Silencer UC	For mounting in exhaust ports	16

# Solenoid valves MHE2, fast-switching valves

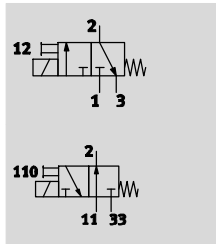
Technical data – Individual valve, 3/2-way valve

Function



-  Voltage  
24 V DC
-  Pressure  
-0.9 ... +8 bar
-  Temperature range  
-5 ... +60 °C



General technical data	
Valve function	3/2 way, single solenoid <sup>1)</sup>
Design	Pressure-relieved poppet valve
Sealing principle	Soft
Reset method	Mechanical spring
Actuation type	Electric
Type of control	Direct
Direction of flow	Reversible with restrictions <sup>2)</sup>
Exhaust air function	With flow control
Manual override	Non-detenting
Mounting position	Any
Width	[mm] 10
Grid dimension	[mm] 14 (minimum distance 4 mm)
Nominal width	[mm] 2
Standard nominal flow rate	[l/min] 100
Type of mounting	Via through-hole
Pneumatic connection	Connecting thread M7
	Push-in connector for tubing O.D. 4 mm
Product weight	[g] 60

- 1) Can be used as a 2/2-way valve by sealing port 3 or 33
- 2) Slight leakage can occur in the pressure range -0.8 bar to +0.5 bar.

Operating and environmental conditions		With fast-switching electronics	Without fast-switching electronics
Operating medium		Compressed air to ISO 8573-1:2010 [7:4:4]	
Note on operating/pilot medium		Lubricated operation possible (in which case lubricated operation will always be required)	
Operating pressure	[bar]	-0.9 ... +8	
	Reversible [bar]	-0.9 ... +1	
Ambient temperature	[°C]	-5 ... +60	
Temperature of medium	[°C]	-5 ... +60	
Restricted ambient and media temperature		As a function of switching frequency (see diagram)	
Corrosion resistance class CRC <sup>1)</sup>		2	
CE marking (see declaration of conformity)		To EU EMC Directive <sup>2)</sup>	-
Certification		c UL us Recognized (OL)	c UL us Recognized (OL)
		RCM trademark	-

- 1) Corrosion resistance class 2 according to Festo standard 940 070  
Components subject to moderate corrosion stress. Externally visible parts with primarily decorative surface requirements which are in direct contact with a normal industrial environment or media such as coolants or lubricating agents.
- 2) For information about the applicability of the component see the manufacturer's EC declaration of conformity at: [www.festo.com/sp](http://www.festo.com/sp) → Certificates.  
If the component is subject to restrictions on usage in residential, office or commercial environments or small businesses, further measures to reduce the emitted interference may be necessary.

# Solenoid valves MHE2, fast-switching valves

FESTO

Technical data – Individual valve, 3/2-way valve

Electrical data		With fast-switching electronics	Without fast-switching electronics
Electrical connection		Pug, 2-pin or moulded-in cable	
Operating voltage	[V DC]	24 ±10%	
Power consumption	[W]	5 for approx. 3 ms (high-current phase, pick-up current 1 A)	2.88
	[W]	1.25 (low-current phase)	–
Protection against incorrect polarity		Bipolar	–
Additional functions		Spark arresting	–
		Holding current reduction	–
		Protective circuit	–
Degree of protection to EN 60529	With moulded-in cable	IP65	IP65
	With connecting cable NEBV	IP65	IP65
	With plug socket with cable KMYZ-4	IP50	IP50
	With adapter VAVE-C8	IP65	IP65

Response times and switching frequencies				With fast-switching electronics	Without fast-switching electronics
Switching time	On	[ms]	1.7 +10% ... –30%	7	
	Off	[ms]	2 +10% ... –30%	3.5	
Switching time variation at 1 Hz and above		[ms]	0.2	–	
Maximum switching frequency		[Hz]	330 <sup>1)</sup>	130	

1) The ambient temperature must be limited with frequencies in excess of 125 Hz.

Safety data	
Resistance to shocks	Shock test with severity level 2 to FN 942017-5 and EN 60068-2-27
Vibration resistance	Transport application test with severity level 2 to FN 942017-4 and EN 60068-2-6

## Materials

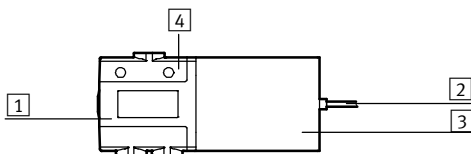

1	Housing	Die-cast zinc, coated
2	Cable sheath	PUR
3	Coil housing	PA
4	Manifold rail	PA
–	Screws	Galvanised steel
–	Seals	HNBR, NBR
Note on materials		Free of copper and PTFE RoHS-compliant <sup>1)</sup>

1) Not RoHS-compliant: MHE2-MS1H-3/2G-M7, MHE2-MS1H-3/2G-QS-4, MHE2-MS1H-3/2G-M7-K, MHE2-MS1H-3/20-QS-4-K, MHE2-MS1H-3/2G-QS-4-K, MHE2-M1H-3/20-M7-K

# Solenoid valves MHE2, fast-switching valves

Technical data – Individual valve, 3/2-way valve

## Restricted ambient and media temperature as a function of switching frequency

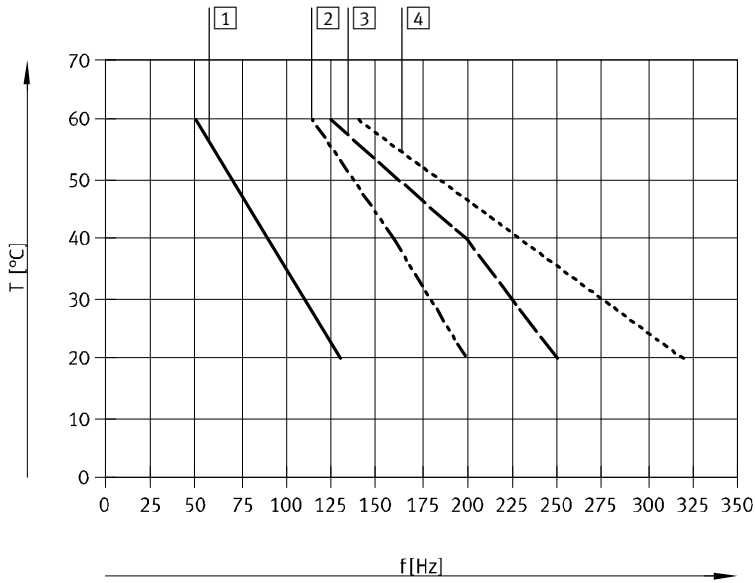

- 1 Manifold, 6 valves, pressureless
- 2 Manifold, 6 valves, flow through, 6 bar
- 3 Individual valve, pressureless
- 4 Individual valve, flow through, 6 bar

## Current curve for valves with fast-switching electronics (MHE2-MS1H)

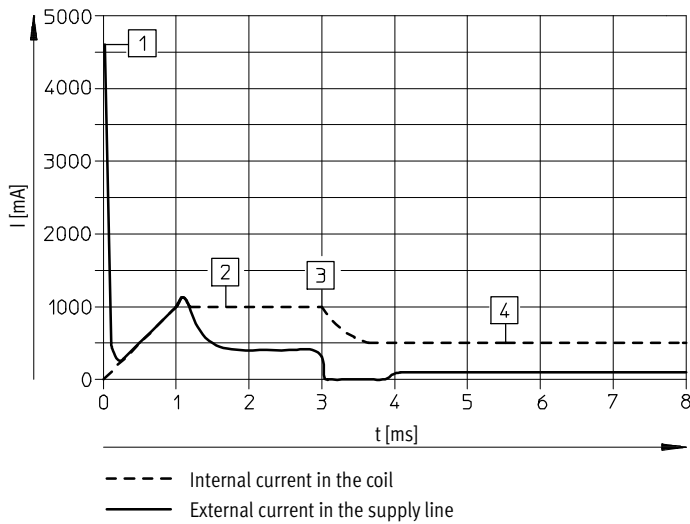

- 1 Capacitor charging
- 2 Controlled coil current 1 A
- 3 Reduction to holding current
- 4 Controlled holding current 0.5 A

# Solenoid valves MHE2, fast-switching valves

Technical data – Individual valve, 3/2-way valve



## Dimensions

Download CAD data → [www.festo.com](http://www.festo.com)

Valve with plug vanes or moulded-in cable

MHE2-...-3/O...-M7

MHE2-...-3/O...-QS-4

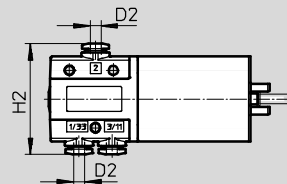
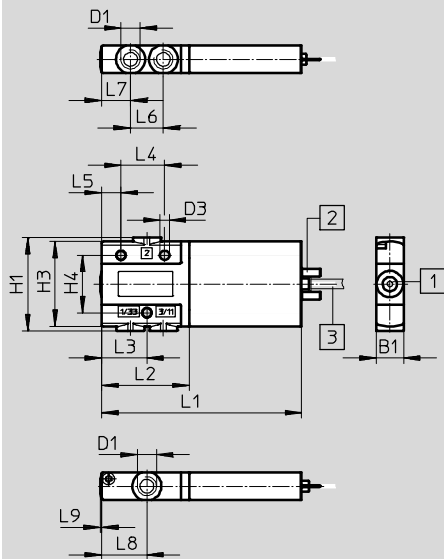

- 1 Manual override, non-detenting
- 2 Plug vanes
- 3 Cable 2.5 m

## Mounting bracket MHE2-BG-L

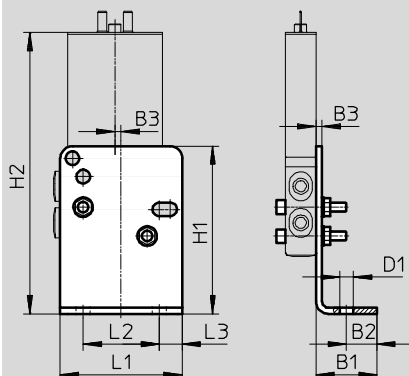

Type	B1	B2	B3	D1	D2 Ø	D3 Ø	H1	H2	H3	H4	L1	L2	L3	L4	L5	L6	L7	L8	L9
MHE2-...-3/O...-M7	10	-	-	M7	-	3.4	34	-	31	21	73	32	16.5	16	7	12	10.5	16.5	0.5
MHE2-...-3/O...-QS-4	10	-	-	-	4	3.4	34	40.4	31	21	73	32	16.5	16	7	12	10.5	16.5	0.5
MHE2-BG-L	20	10	2	4.5	-	-	55	92.3	-	-	40	25	7.5	-	-	-	-	-	-

# Solenoid valves MHE2, fast-switching valves



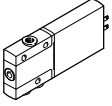
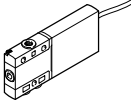

Technical data – Individual valve, 3/2-way valve

Ordering data					Part No.	Type
Valves						
	Electrical connection: plug vanes	With fast-switching electronics, switching time 2 ms	Pneumatic connection: thread M7	Normally open	<b>196151</b>	<b>MHE2-MS1H-3/20-M7</b>
				Normally closed	<b>196131</b>	<b>MHE2-MS1H-3/2G-M7<sup>1)</sup></b>
			Pneumatic connection: push-in connector for tubing O.D. 4 mm	Normally open	<b>196155</b>	<b>MHE2-MS1H-3/20-QS-4</b>
				Normally closed	<b>196135</b>	<b>MHE2-MS1H-3/2G-QS-4<sup>1)</sup></b>
		Without fast-switching electronics, switching time 7 ms	Pneumatic connection: thread M7	Normally open	<b>196150</b>	<b>MHE2-M1H-3/20-M7</b>
				Normally closed	<b>196130</b>	<b>MHE2-M1H-3/2G-M7</b>
			Pneumatic connection: push-in connector for tubing O.D. 4 mm	Normally open	<b>196154</b>	<b>MHE2-M1H-3/20-QS-4</b>
				Normally closed	<b>196134</b>	<b>MHE2-M1H-3/2G-QS-4</b>
	Electrical connection: cable	With fast-switching electronics, switching time 2 ms	Pneumatic connection: thread M7	Normally open	<b>196153</b>	<b>MHE2-MS1H-3/20-M7-K</b>
				Normally closed	<b>196133</b>	<b>MHE2-MS1H-3/2G-M7-K<sup>1)</sup></b>
			Pneumatic connection: push-in connector for tubing O.D. 4 mm	Normally open	<b>196157</b>	<b>MHE2-MS1H-3/20-QS-4-K<sup>1)</sup></b>
				Normally closed	<b>196137</b>	<b>MHE2-MS1H-3/2G-QS-4-K<sup>1)</sup></b>
		Without fast-switching electronics, switching time 7 ms	Pneumatic connection: thread M7	Normally open	<b>196152</b>	<b>MHE2-M1H-3/20-M7-K<sup>1)</sup></b>
				Normally closed	<b>196132</b>	<b>MHE2-M1H-3/2G-M7-K</b>
			Pneumatic connection: push-in connector for tubing O.D. 4 mm	Normally open	<b>196156</b>	<b>MHE2-M1H-3/20-QS-4-K</b>
				Normally closed	<b>196136</b>	<b>MHE2-M1H-3/2G-QS-4-K</b>

1) Not RoHS-compliant

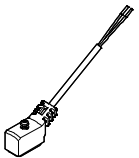
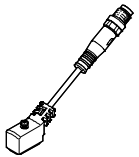
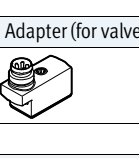
# Solenoid valves MHE2, fast-switching valves

Technical data – Individual valve, 3/2-way valve

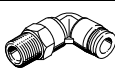
Ordering data					Part No.	Type	
Connecting cable (for valves with plug vanes)					Technical data → Internet: nebv		
	2-pin socket, open cable end 2-wire	PUR cable, degree of protection IP65	Signal status display with LED	2.5 m long	<b>8047671</b>	<b>NEBV-Z4WA2L-P-E-2.5-N-LE2-S1</b>	
				5 m long	<b>8047672</b>	<b>NEBV-Z4WA2L-P-E-5-N-LE2-S1</b>	
				10 m long	<b>8047670</b>	<b>NEBV-Z4WA2L-P-E-10-N-LE2-S1</b>	
	2-pin socket, plug M8x1 3-pin	PVC cable, degree of protection IP50	Without signal status display	0.5 m long	<b>193690</b>	<b>KMYZ-4-24-0,5-B</b>	
				2.5 m long	<b>193691</b>	<b>KMYZ-4-24-2,5-B</b>	
	2-pin socket, plug M8x1 3-pin	PUR cable, degree of protection IP65	Signal status display with LED	0.5 m long	<b>8047673</b>	<b>NEBV-Z4WA2L-P-E-0.5-N-M8G3-S1</b>	
				2.5 m long	<b>8047674</b>	<b>NEBV-Z4WA2L-P-E-2.5-N-M8G3-S1</b>	
Adapter (for valves with plug vanes)							
	2-pin socket	Signal status display with LED	Plug M8, 3-pin	<b>571686</b>	<b>VAVE-C8-1R8</b>		
			Plug M8, 4-pin	<b>573194</b>	<b>VAVE-C8-1R1</b>		
Wall mounting							
	Mounting bracket			<b>196165</b>	<b>MHE2-BG-L</b>		
Silencer							
	Push-in sleeve with O.D. 4 mm		1 piece	<b>165006</b>	<b>UC-QS-4H</b>		
	With M7 threaded connection		1 piece	<b>161418</b>	<b>UC-M7</b>		
			50 pieces	<b>534218</b>	<b>UC-M7-50</b>		
Push-in fitting							
	Male thread M7 with internal hex for tubing O.D.		4 mm	10 pieces	<b>153319</b>	<b>QSM-M7-4-I</b>	
				100 pieces	<b>133006</b>	<b>QSM-M7-4-I-100</b>	
			6 mm	10 pieces	<b>153321</b>	<b>QSM-M7-6-I</b>	
	Male thread M7 with external hex, push-in L-fitting rotatable through 360° for tubing O.D.		4 mm	10 pieces	<b>186352</b>	<b>QSML-M7-4</b>	
				100 pieces	<b>130773</b>	<b>QSML-M7-4-100</b>	
			6 mm	10 pieces	<b>186353</b>	<b>QSML-M7-6</b>	
				100 pieces	<b>130774</b>	<b>QSML-M7-6-100</b>	



# Solenoid valves MHE2, fast-switching valves

Peripherals overview – Individual valve, 5/2-way valve

Connection with plug vanes – Connection with moulded-in cable

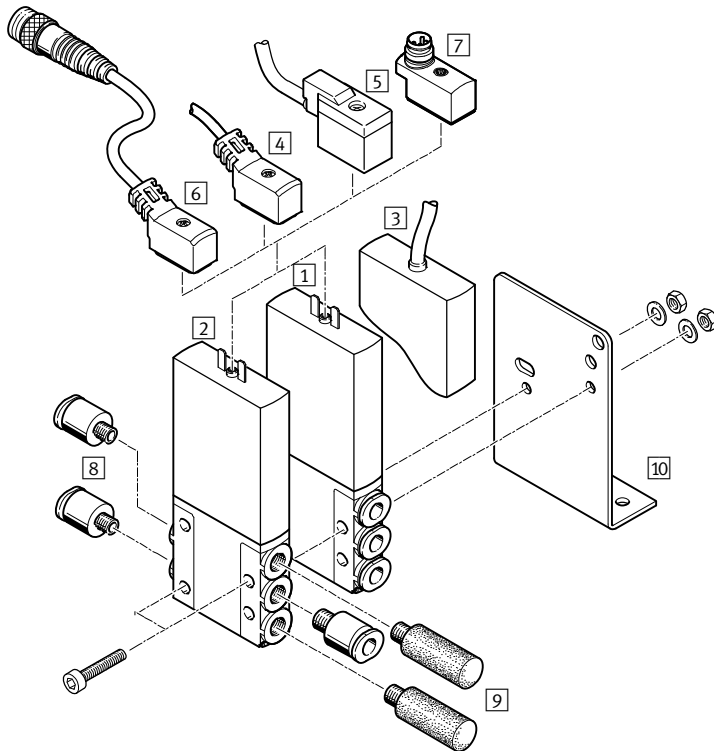

Designation	Brief description	→ Page/Internet
1 Individual valve MHE2-...QS-4	With plug vanes and push-in connector for compressed air tubing with standard O.D.	22
2 Individual valve MHE2-...-M7	With plug vanes and connection M7	22
3 Individual valve MHE2-...-K	With moulded-in cable, IP65	22
4 Connecting cable NEBV	PUR cable, signal status display with LED, IP65	22
5 Plug socket with cable KMYZ-4	PVC cable, without signal status display, IP50	22
6 Connecting cable NEBV	PUR cable, signal status display with LED, plug M8x1 3-pin, IP65	22
7 Adapter VAVE-C8	For connecting the valves via connecting cable M8 3-pin or 4-pin, IP65	22
8 Push-in fittings QS	For connecting compressed air tubing with standard O.D.	22
9 Silencer UC	For installation in exhaust ports	22
10 Mounting bracket MHE2-BG-L	For wall mounting	22

# Solenoid valves MHE2, fast-switching valves

Technical data – Individual valve, 5/2-way valve

FESTO

Function

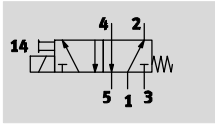

-  - Voltage  
24 V DC

-  - Pressure  
-0.9 ... +8 bar

-  - Temperature range  
-5 ... +60 °C



General technical data		
Valve function		5/2-way, single solenoid
Design		Pressure-relieved poppet valve
Sealing principle		Soft
Reset method		Mechanical spring
Actuation type		Electric
Type of control		Direct
Direction of flow		Non-reversible
Exhaust function		With flow control
Manual override		Non-detenting
Mounting position		Any
Width	[mm]	10
Grid dimension	[mm]	14
Nominal width	[mm]	2
Standard nominal flow rate	[l/min]	90
Type of mounting		Via through-hole
Pneumatic connection		Connecting thread M7 Push-in connector for tubing O.D. 4 mm
Tightening torque for fitting	[Nm]	Max. 2
Product weight	[g]	70

Operating and environmental conditions		
Operating medium		Compressed air to ISO 8573-1:2010 [7:4:4]
Note on operating/pilot medium		Lubricated operation possible (in which case lubricated operation will always be required)
Operating pressure	[bar]	-0.9 ... +8
Ambient temperature	[°C]	-5 ... +60
Temperature of medium	[°C]	-5 ... +60
Restricted ambient and media temperature		As a function of switching frequency (see diagram)
Corrosion resistance class CRC <sup>1)</sup>		2
CE marking (see declaration of conformity)		To EU EMC Directive <sup>2)</sup>
Approval certificate		cULus Recognized (OL) RCM trademark

- 1) Corrosion resistance class 2 according to Festo standard 940 070  
Components subject to moderate corrosion stress. Externally visible parts with primarily decorative surface requirements which are in direct contact with a normal industrial environment or media such as coolants or lubricating agents.
- 2) For information about the applicability of the component see the manufacturer's EC declaration of conformity at: [www.festo.com/sp](http://www.festo.com/sp) → Certificates.  
If the component is subject to restrictions on usage in residential, office or commercial environments or small businesses, further measures to reduce the emitted interference may be necessary.

# Solenoid valves MHE2, fast-switching valves

Technical data – Individual valve, 5/2-way valve

Electrical data			
Electrical connection		2-pin plug or moulded-in cable	
Operating voltage		[V DC]	24 ±10%
Power consumption	Low-current phase	[W]	1.625
	High-current phase	[W]	6.5
Protection against incorrect polarity		Bipolar	
Additional functions		Spark arresting	
		Holding current reduction	
		Protective circuit	
Degree of protection to EN 60529	With moulded-in cable		IP65
	With connecting cable NEBV		IP65
	With plug socket with cable KMYZ-4		IP50
	With adapter VAVE-C8		IP65

Response times and switching frequencies			
Switching time	On	[ms]	1.9 +10% ... -30%
	Off	[ms]	1.7 +10% ... -30%
Switching time variation at 1 Hz and above		[ms]	0.2
Maximum switching frequency		[Hz]	300 <sup>1)</sup>

1) The ambient temperature must be limited with frequencies in excess of 100 Hz.

Safety data	
Resistance to shocks	Shock test with severity level 2 to FN 942017-5 and EN 60068-2-27
Vibration resistance	Transport application test with severity level 2 to FN 942017-4 and EN 60068-2-6

## Materials

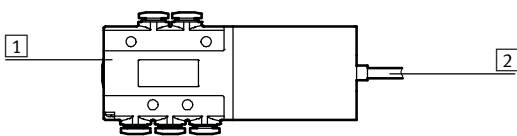

1	Housing	Die-cast zinc, coated
2	Cable sheath	PUR
-	Seals	HNBR, NBR
-	Screws	Galvanised steel
Note on materials		Free of copper and PTFE RoHS-compliant

# Solenoid valves MHE2, fast-switching valves

Technical data – Individual valve, 5/2-way valve

## Restricted ambient and media temperature as a function of switching frequency

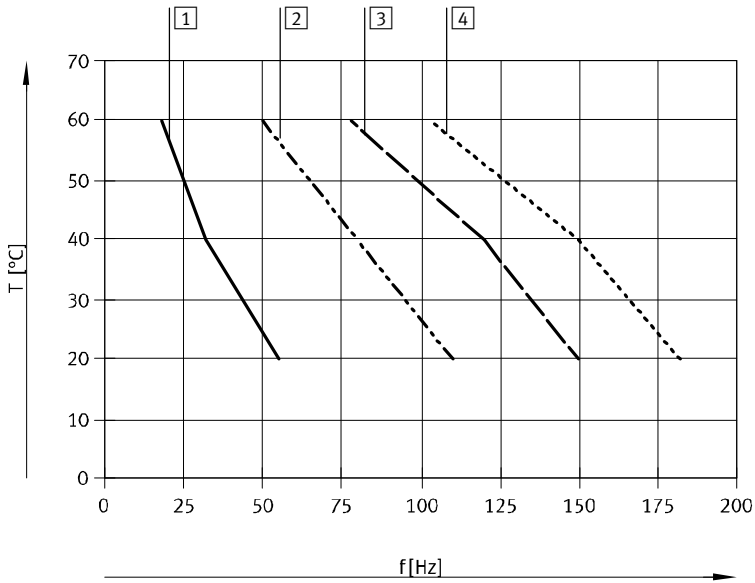

- 1 Manifold, 6 valves, pressureless
- 2 Manifold, 6 valves, flow through, 6 bar
- 3 Individual valve, pressureless
- 4 Individual valve, flow through, 6 bar

## Current curve for valves with fast-switching electronics (MHE2-MS1H)

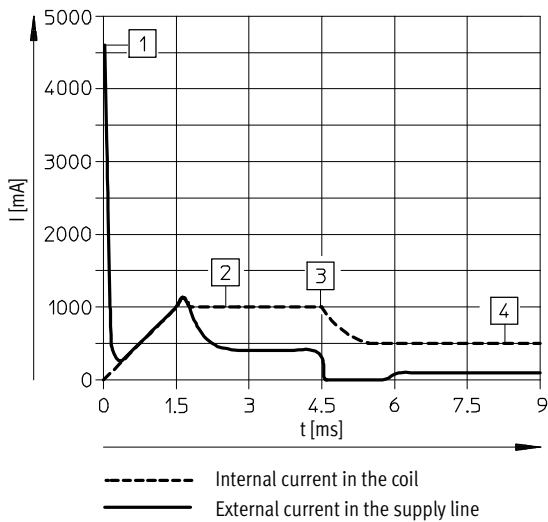

- 1 Capacitor charging
- 2 Controlled coil current 1 A
- 3 Reduction to holding current
- 4 Controlled holding current 0.5 A

# Solenoid valves MHE2, fast-switching valves

Technical data – Individual valve, 5/2-way valve

## Dimensions

Download CAD data → [www.festo.com](http://www.festo.com)

Valve with plug vanes or moulded-in cable

MHE2...-5/2-M7

MHE2...-5/2-QS-4

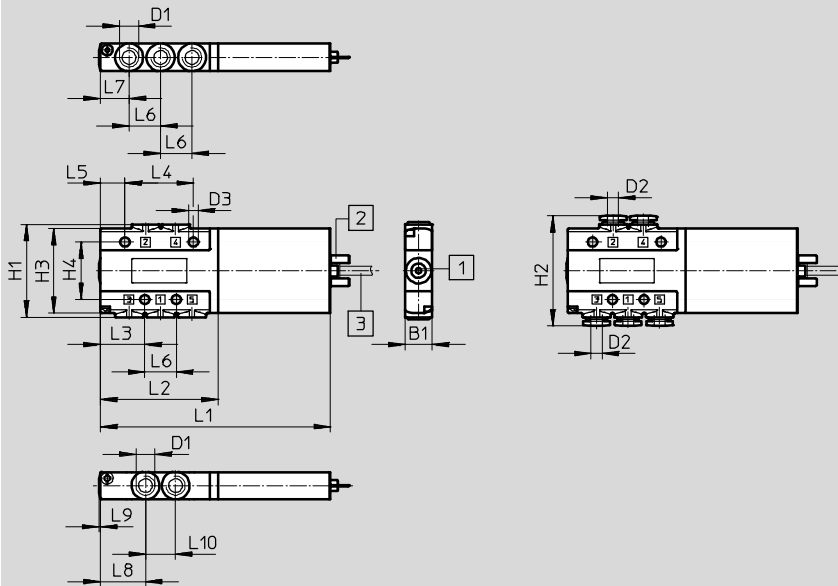

## Mounting bracket MHE2-BG-L

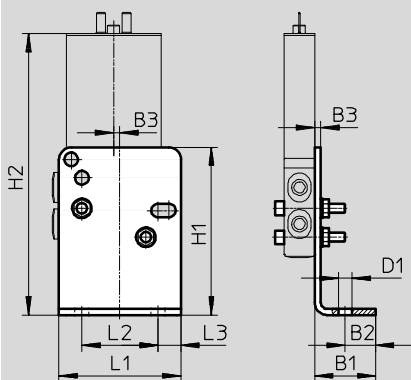





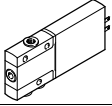
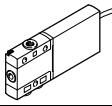

Type	B1	B2	B3	D1	D2	D3	H1	H2	H3	H4	L1	L2	L3	L4	L5	L6	L7	L8	L9	L10
MHE2...-5/2-M7	10	-	-	M7	-	3.4	34	-	31	21	84	43	16.3	25	9	11.5	10.5	16.5	0.5	11
MHE2...-5/2-QS-4	10	-	-	-	4	3.4	34	40.4	31	21	84	43	16.3	25	9	11.5	10.5	16.5	0.5	11
MHE2-BG-L	20	10	2	4.5	-	-	55	92.3	-	-	40	25	7.5	-	-	-	-	-	-	-

# Solenoid valves MHE2, fast-switching valves

FESTO

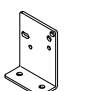
Technical data – Individual valve, 5/2-way valve

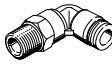
Ordering data					Part No.	Type	
<b>Valves</b>							
	Electrical connection: plug vanes	With fast-switching electronics, switching time 2 ms	Pneumatic connection: thread M7		<b>525113</b>	<b>MHE2-MS1H-5/2-M7</b>	
			Pneumatic connection: push-in connector for tubing O.D. 4 mm		<b>525117</b>	<b>MHE2-MS1H-5/2-QS-4</b>	
	Electrical connection: cable	With fast-switching electronics, switching time 2 ms	Pneumatic connection: thread M7		<b>525115</b>	<b>MHE2-MS1H-5/2-M7-K</b>	
			Pneumatic connection: push-in connector for tubing O.D. 4 mm		<b>525119</b>	<b>MHE2-MS1H-5/2-QS-4-K</b>	
<b>Connecting cable (for valves with plug vanes)</b> <span style="float: right;">Technical data → Internet: nebv</span>							
	2-pin socket, open cable end 2-wire	PUR cable, degree of protection IP65	Signal status display with LED	2.5 m long	<b>8047671</b>	<b>NEBV-Z4WA2L-P-E-2.5-N-LE2-S1</b>	
				5 m long	<b>8047672</b>	<b>NEBV-Z4WA2L-P-E-5-N-LE2-S1</b>	
				10 m long	<b>8047670</b>	<b>NEBV-Z4WA2L-P-E-10-N-LE2-S1</b>	
	2-pin socket, plug M8x1 3-pin	PUR cable, degree of protection IP65	Signal status display with LED	0.5 m long	<b>193690</b>	<b>KMYZ-4-24-0,5-B</b>	
				2.5 m long	<b>193691</b>	<b>KMYZ-4-24-2,5-B</b>	
				0.5 m long	<b>8047673</b>	<b>NEBV-Z4WA2L-P-E-0.5-N-M8G3-S1</b>	
				2.5 m long	<b>8047674</b>	<b>NEBV-Z4WA2L-P-E-2.5-N-M8G3-S1</b>	
<b>Adapter (for valves with plug vanes)</b>							
	2-pin socket	Signal status display with LED	Plug M8, 3-pin		<b>571686</b>	<b>VAVE-C8-1R8</b>	
			Plug M8, 4-pin		<b>573194</b>	<b>VAVE-C8-1R1</b>	
<b>Wall mounting</b>							
	Mounting bracket				<b>196165</b>	<b>MHE2-BG-L</b>	
<b>Silencer</b> <span style="float: right;">Technical data → Internet: uc</span>							
	Push-in sleeve with O.D. 4 mm		1 piece	<b>165006</b>	<b>UC-QS-4H</b>		
	With M7 threaded connection		1 piece	<b>161418</b>	<b>UC-M7</b>		
			50 pieces	<b>534218</b>	<b>UC-M7-50</b>		
<b>Push-in fitting</b> <span style="float: right;">Technical data → Internet: qs</span>							
	Male thread M7 with internal hex for tubing O.D.		4 mm	10 pieces	<b>153319</b>	<b>QSM-M7-4-I</b>	
				100 pieces	<b>133006</b>	<b>QSM-M7-4-I-100</b>	
			6 mm	10 pieces	<b>153321</b>	<b>QSM-M7-6-I</b>	
	Male thread M7 with external hex, push-in L-fitting rotatable through 360° for tubing O.D.		4 mm	10 pieces	<b>186352</b>	<b>QSML-M7-4</b>	
				100 pieces	<b>130773</b>	<b>QSML-M7-4-100</b>	
			6 mm	10 pieces	<b>186353</b>	<b>QSML-M7-6</b>	
				100 pieces	<b>130774</b>	<b>QSML-M7-6-100</b>	

# Solenoid valves MHP2, fast-switching valves

Peripherals overview – Semi in-line valve, 3/2-way valve

## Connection via plug vanes

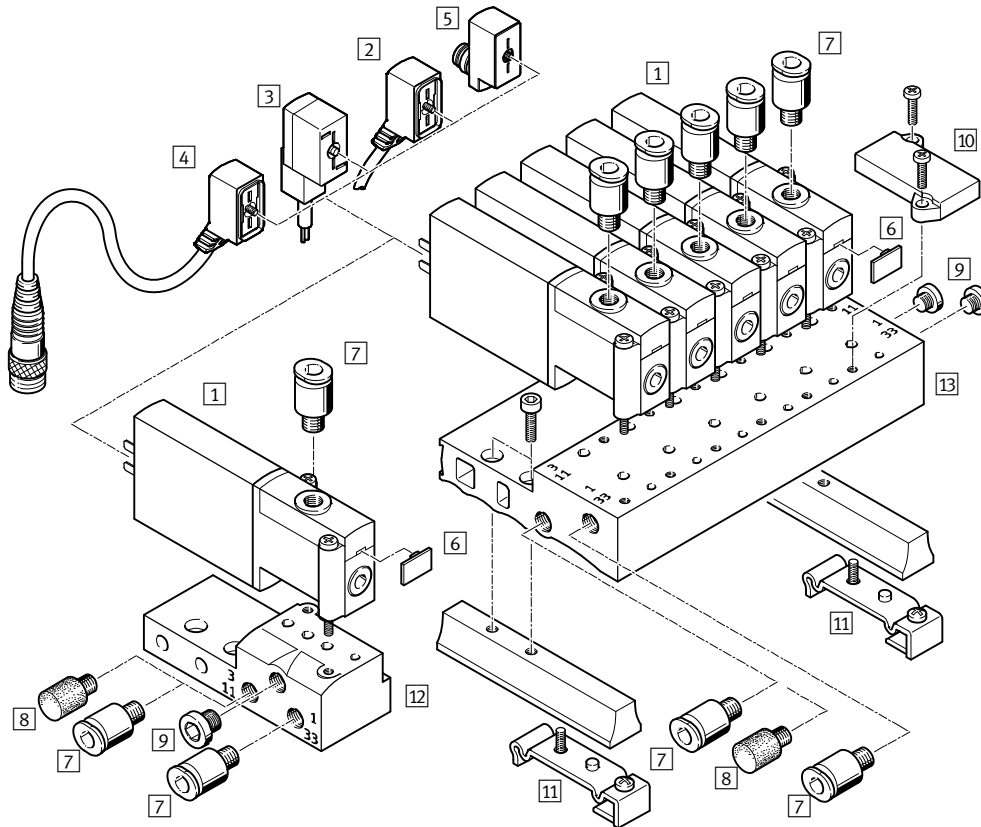

Designation	Brief description	→ Page/Internet
1 Semi in-line valve MHP2	With plug vanes	30
2 Connecting cable NEBV	PUR cable, signal status display with LED, IP65	30
3 Plug socket with cable KMYZ-4	PVC cable, without signal status display, IP50	30
4 Connecting cable NEBV	PUR cable, signal status display with LED, plug M8x1 3-pin, IP65	30
5 Adapter VAVE-C8	For connecting the valves via connecting cable M8 3-pin or 4-pin, IP65	30
6 Inscription label MH-BZ-80X	For identifying the valves	31
7 Push-in fittings QS	For connecting compressed air tubing with standard O.D.	31
8 Silencer UC	For mounting in exhaust ports	31
9 Blanking plug B	For sealing unused ports	31
10 Cover plate MHAP2-BP-3	For sealing vacant positions	30
11 H-rail mounting MHAP2-BG-NRH-35	For mounting the manifold block on H-rails according to EN 60715	30
12 Individual sub-base MHA2-AS-3-M5	For semi in-line valves, the individual sub-base is also used for sub-base valves and must be sealed with a blanking plug here	30
13 Manifold block MHP2-PR...-3	For semi in-line valves	30

# Solenoid valves MHP2, fast-switching valves

Technical data – Semi in-line valve, 3/2-way valve

FESTO

Function

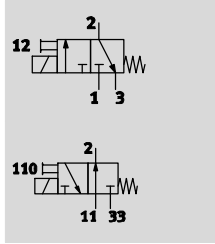

- - Voltage  
24 V DC

- - Pressure  
-0.9 ... +8 bar

- - Temperature range  
-5 ... +40 °C

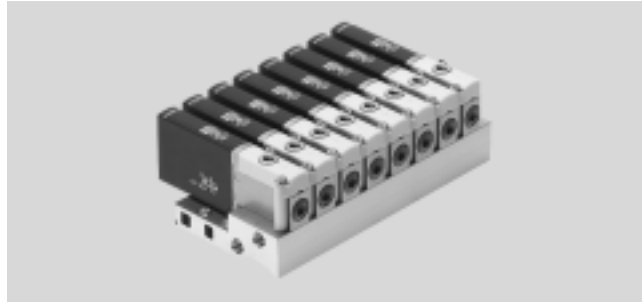

General technical data		
Valve function		3/2 way, single solenoid <sup>1)</sup>
Design		Pressure-relieved poppet valve
Sealing principle		Soft
Reset method		Mechanical spring
Actuation type		Electric
Type of control		Direct
Direction of flow		Reversible with restrictions <sup>2)</sup>
Exhaust air function		With flow control
Manual override		Non-detenting
Mounting position		Any
Width	[mm]	10
Grid dimension	[mm]	14
Nominal width	[mm]	2
Standard nominal flow rate	[l/min]	100
Type of mounting		On PR rail
Pneumatic connection	2 1, 3, 11, 33	Connecting thread M5 Sub-base
Product weight	[g]	60

1) Can be used as a 2/2-way valve by sealing port 3 or 33.

2) Slight leakage can occur in the pressure range -0.8 bar to +0.5 bar.

Operating and environmental conditions	With fast-switching electronics		Without fast-switching electronics	
	Operating medium	Compressed air to ISO 8573-1:2010 [7:4:4]		
Note on operating/pilot medium	Lubricated operation possible (in which case lubricated operation will always be required)			
Operating pressure	[bar]	-0.9 ... +8		
	Reversible	[bar]	-0.9 ... +1	
Ambient temperature	[°C]	-5 ... +40		
Temperature of medium	[°C]	-5 ... +40		
Restricted ambient and media temperature	As a function of switching frequency (see diagram)			
Corrosion resistance class CRC <sup>1)</sup>	2			
CE marking (see declaration of conformity)	To EU EMC Directive <sup>2)</sup>		-	
Certification	c UL us Recognized (OL)		c UL us Recognized (OL)	
	RCM trademark		-	

1) Corrosion resistance class 2 according to Festo standard 940 070

Components subject to moderate corrosion stress. Externally visible parts with primarily decorative surface requirements which are in direct contact with a normal industrial environment or media such as coolants or lubricating agents.

2) For information about the applicability of the component see the manufacturer's EC declaration of conformity at: [www.festo.com/sp](http://www.festo.com/sp) → Certificates.

If the component is subject to restrictions on usage in residential, office or commercial environments or small businesses, further measures to reduce the emitted interference may be necessary.



# Solenoid valves MHP2, fast-switching valves

Technical data – Semi in-line valve, 3/2-way valve

Electrical data		With fast-switching electronics	Without fast-switching electronics
Electrical connection		2-pin plug or moulded-in cable	
Operating voltage	[V DC]	24 ±10%	
Power consumption	[W]	5 for approx. 3 ms (high-current phase, pick-up current 1 A)	2.88
	[W]	1.25 (low-current phase)	–
Protection against incorrect polarity		Bipolar	–
Additional functions		Spark arresting	–
		Holding current reduction	–
		Protective circuit	–
Degree of protection to EN 60529	With moulded-in cable	IP65	IP65
	With connecting cable NEBV	IP65	IP65
	With plug socket with cable KMYZ-4	IP50	IP50
	With adapter VAVE-C8	IP65	IP65

Response times and switching frequencies				With fast-switching electronics	Without fast-switching electronics
Switching time	On	[ms]		1.7 +10% ... -30%	7
	Off	[ms]		2 +10% ... -30%	3.5
Switching time variation at 1 Hz and above		[ms]		0.2	–
Maximum switching frequency		[Hz]		330 <sup>1)</sup>	130

1) The ambient temperature must be limited with frequencies in excess of 100 Hz.

Safety data	
Resistance to shocks	Shock test with severity level 2 to FN 942017-5 and EN 60068-2-27
Vibration resistance	Transport application test with severity level 2 to FN 942017-4 and EN 60068-2-6

## Materials

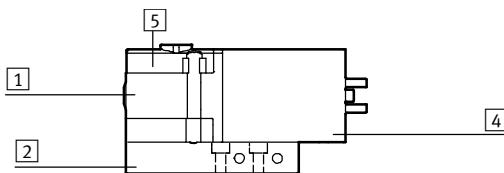

1	Housing	Die-cast zinc, coated
2	Sub-base	Aluminium in the case of the manifold, die-cast zinc in the case of the individual sub-base
4	Coil housing	PA
5	Manifold rail	PA
–	Seals	HNBR, NBR
–	Screws	Galvanised steel
Note on materials		Free of copper and PTFE RoHS-compliant

# Solenoid valves MHP2, fast-switching valves

Technical data – Semi in-line valve, 3/2-way valve

## Restricted ambient and media temperature as a function of switching frequency

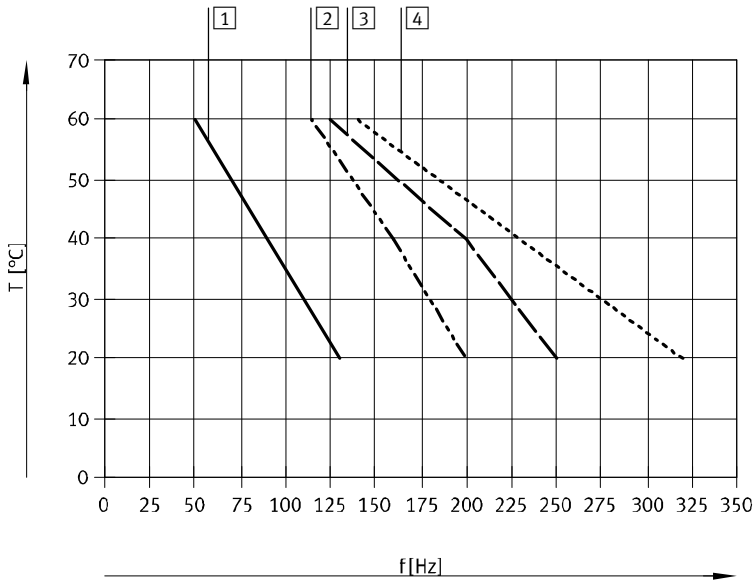

- 1 Manifold, 6 valves, pressureless
- 2 Manifold, 6 valves, flow through, 6 bar
- 3 Individual valve, pressureless
- 4 Individual valve, flow through, 6 bar

## Current curve for valves with fast-switching electronics (MHP2-MS1H)

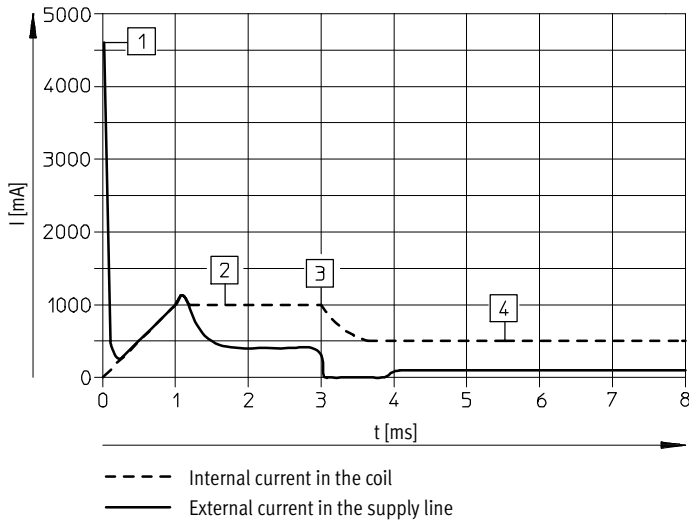

- 1 Capacitor charging
- 2 Controlled coil current 1 A
- 3 Reduction to holding current
- 4 Controlled holding current 0.5 A

# Solenoid valves MHP2, fast-switching valves

Technical data – Semi in-line valve, 3/2-way valve

## Dimensions

Download CAD data → [www.festo.com](http://www.festo.com)

Valve with plug vanes, MHP2-...-3/2...-M5

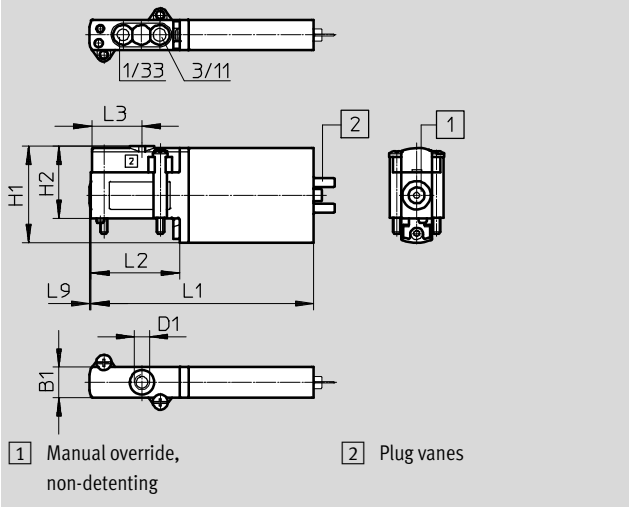

Hole pattern on sub-bases

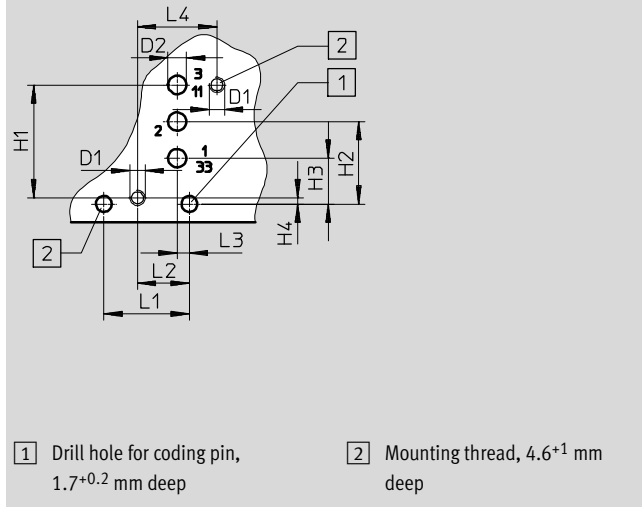

Type	B1	D1	D2 Ø	H1	H2	H3	H4	L1	L2	L3	L4	L9
MHP2-...-3/2...-M5	10	M5	-	31.6	23.6	-	-	73	29	16.5	-	0.5
Hole pattern	-	M2.5	3	18.5	13.5	7.5	1	14	8.5	2	13	-

# Solenoid valves MHP2, fast-switching valves

Technical data – Semi in-line valve, 3/2-way valve

## Dimensions

Download CAD data → [www.festo.com](http://www.festo.com)

Individual sub-base, MHA2-AS-3-M5

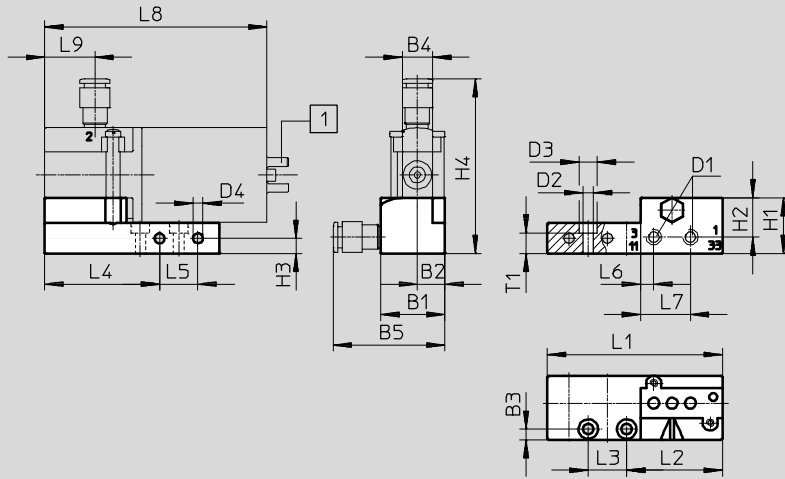

1 Plug vanes

H-rail mounting MHAP2-BG-NRH-35

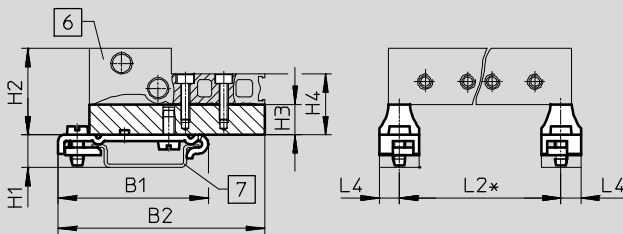

6 Connection block/manifold block  
7 DIN mounting rail  
\* See dimensions table for manifold block used

Type	B1	B2	B3	B4	B5	D1	D2	D3	D4	H1	H2	H3	H4	L1	L2	L3	L4	L5	L6	L7	L8	L9	T1
MHA2-AS-3-M5	21	9	3.5	10	36.6	M5	3.4	6	3.3	18.3	12.9	5	57.4	57.4	31.4	12.6	37.7	12.6	4.3	16.3	73	16.5	6.8
MHAP2-BG-NRH-35	49.1	67.6	-	-	-	-	-	-	-	10.7	28.3	10	20	-	*	-	6.5	-	-	-	-	-	-

\* See dimensions table for manifold block used

# Solenoid valves MHP2, fast-switching valves

Technical data – Semi in-line valve, 3/2-way valve

## Dimensions

Download CAD data → [www.festo.com](http://www.festo.com)

Manifold assembly, MHP2-PR...-3

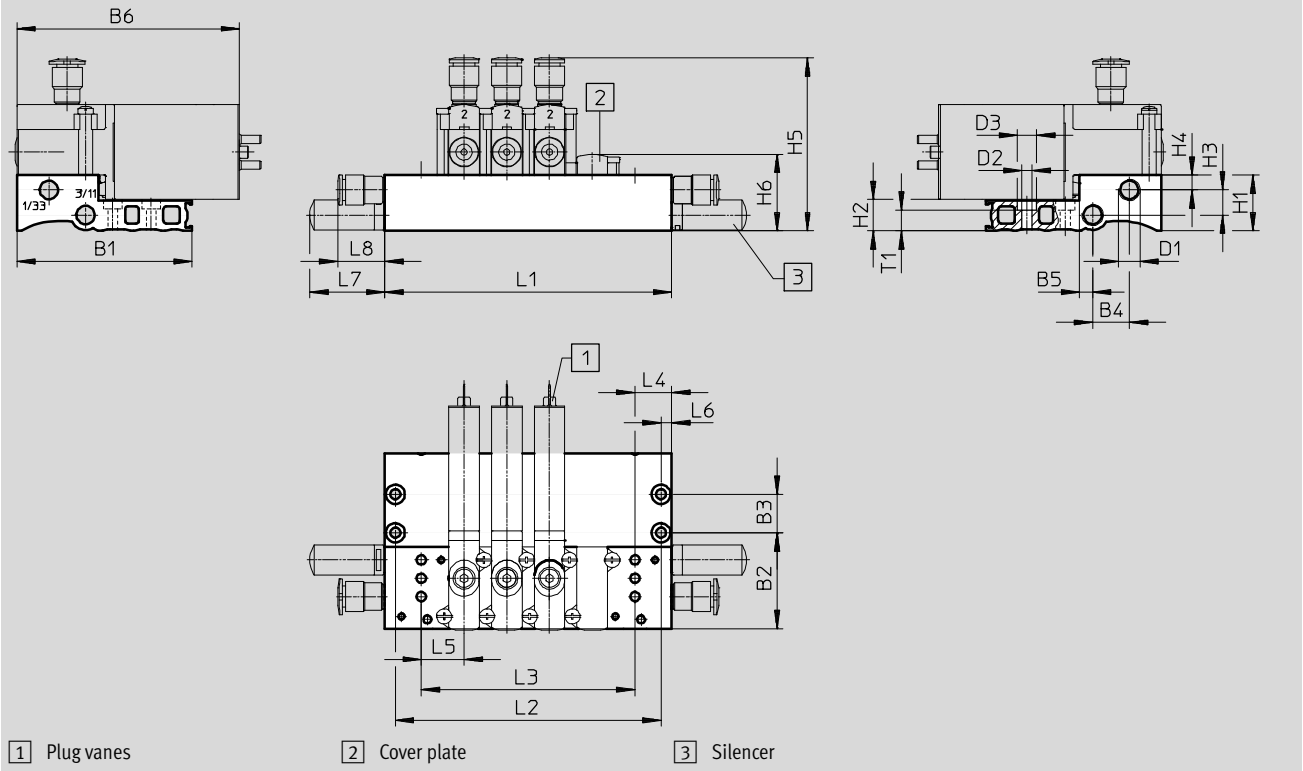

Type	B1	B2	B3	B4	B5	B6	D1	D2	D3	H1	H2	H3	H4	H5	H6	L4	L5	L6	L7	L8	T1
MHP2-PR...-3	57.4	31.4	12.6	12	4.3	73	M7	3.3	6.3	18.3	10	8.2	4.9	56.7	25.1	12	14	3.5	24.5	15.4	6.8







Type		Number of valve positions				
		2	4	6	8	10
MHP2-PR...-3	L1	38	66	94	122	150
	L2	31	59	87	115	143
	L3	14	42	70	98	126

-  - Note  
 Valve types 3/2G and 3/2O must not be mixed on one manifold block.

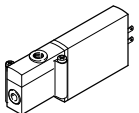
# Solenoid valves MHP2, fast-switching valves

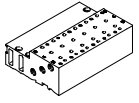
FESTO

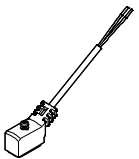
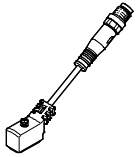

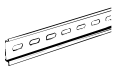

Technical data – Semi in-line valve, 3/2-way valve

Ordering data					Part No.	Type
<b>Valves</b>						
	With fast-switching electronics	Switching time on 1.7 ms	Normally open	<b>196143</b>	<b>MHP2-MS1H-3/2O-M5</b>	
			Normally closed	<b>196123</b>	<b>MHP2-MS1H-3/2G-M5</b>	
	Without fast-switching electronics	Switching time on 7 ms	Normally open	<b>196142</b>	<b>MHP2-M1H-3/2O-M5</b>	
			Normally closed	<b>196122</b>	<b>MHP2-M1H-3/2G-M5</b>	
<b>Manifold rail</b>						
	Individual sub-base <sup>1)</sup> Pneumatic connection: thread M5		1 valve position	<b>197438</b>	<b>MHA2-AS-3-M5</b>	
	Manifold block Pneumatic connection: thread M7		2 valve positions	<b>197442</b>	<b>MHP2-PR2-3</b>	
			4 valve positions	<b>197443</b>	<b>MHP2-PR4-3</b>	
			6 valve positions	<b>197444</b>	<b>MHP2-PR6-3</b>	
			8 valve positions	<b>197445</b>	<b>MHP2-PR8-3</b>	
			10 valve positions	<b>197446</b>	<b>MHP2-PR10-3</b>	
<b>Blanking plate</b>						
	Vacant valve positions must be sealed with a cover plate			<b>197470</b>	<b>MHAP2-BP-3</b>	
<b>Connecting cable</b> <span style="float: right;">Technical data → Internet: nebv</span>						
	2-pin socket, open cable end 2-wire	PUR cable, degree of protection IP65	Signal status display with LED	2.5 m long	<b>8047671</b>	<b>NEBV-Z4WA2L-P-E-2.5-N-LE2-S1</b>
				5 m long	<b>8047672</b>	<b>NEBV-Z4WA2L-P-E-5-N-LE2-S1</b>
				10 m long	<b>8047670</b>	<b>NEBV-Z4WA2L-P-E-10-N-LE2-S1</b>
		PVC cable, degree of protection IP50	Without signal status display	0.5 m long	<b>193690</b>	<b>KMYZ-4-24-0,5-B</b>
				2.5 m long	<b>193691</b>	<b>KMYZ-4-24-2,5-B</b>
	2-pin socket, plug M8x1 3-pin	PUR cable, degree of protection IP65	Signal status display with LED	0.5 m long	<b>8047673</b>	<b>NEBV-Z4WA2L-P-E-0.5-N-M8G3-S1</b>
				2.5 m long	<b>8047674</b>	<b>NEBV-Z4WA2L-P-E-2.5-N-M8G3-S1</b>
<b>Adapter (for valves with plug vanes)</b>						
	2-pin socket	Signal status display with LED	Plug M8, 3-pin	<b>571686</b>	<b>VAVE-C8-1R8</b>	
			Plug M8, 4-pin	<b>573194</b>	<b>VAVE-C8-1R1</b>	
<b>H-rail mounting</b>						
	For 3/2-way solenoid valves			<b>525053</b>	<b>MHAP2-BG-NRH-35</b>	
<b>H-rail</b>						
	To EN 60715			2 m	<b>35430</b>	<b>NRH-35-2000</b>

1) Seal ports 2 and 4 on the individual sub-base with blanking plugs. These ports have no function when using semi in-line valves.

# Solenoid valves MHP2, fast-switching valves

Technical data – Semi in-line valve, 3/2-way valve

Ordering data					
				Part No.	Type
Silencer <span style="float: right;">Technical data → Internet: uc</span>					
	With threaded connection	M5	1 piece	<b>165003</b>	<b>UC-M5</b>
			50 pieces	<b>534217</b>	<b>UC-M5-50</b>
		M7	1 piece	<b>161418</b>	<b>UC-M7</b>
			50 pieces	<b>534218</b>	<b>UC-M7-50</b>
Push-in fitting <span style="float: right;">Technical data → Internet: qs</span>					
	Male thread M5 with internal hex for tubing O.D.	4 mm	10 pieces	<b>153315</b>	<b>QSM-M5-4-I</b>
		6 mm	10 pieces	<b>153317</b>	<b>QSM-M5-6-I</b>
	Male thread M7 with internal hex for tubing O.D.	4 mm	10 pieces	<b>153319</b>	<b>QSM-M7-4-I</b>
			100 pieces	<b>133006</b>	<b>QSM-M7-4-I-100</b>
	Male thread M5 with external hex, push-in L-fitting rotatable through 360° for tubing O.D.	4 mm	10 pieces	<b>153333</b>	<b>QSML-M5-4</b>
			100 pieces	<b>130771</b>	<b>QSML-M5-4-100</b>
		6 mm	10 pieces	<b>153335</b>	<b>QSML-M5-6</b>
			100 pieces	<b>130772</b>	<b>QSML-M5-6-100</b>
	Male thread M7 with external hex, push-in L-fitting rotatable through 360° for tubing O.D.	4 mm	10 pieces	<b>186352</b>	<b>QSML-M7-4</b>
			100 pieces	<b>130773</b>	<b>QSML-M7-4-100</b>
		6 mm	10 pieces	<b>186353</b>	<b>QSML-M7-6</b>
			100 pieces	<b>130774</b>	<b>QSML-M7-6-100</b>
Blanking plug					
	For thread M5		10 pieces	<b>3843</b>	<b>B-M5</b>
	For thread M7		10 pieces	<b>174309</b>	<b>B-M7</b>
Inscription label					
	For solenoid valve		80 pieces in frame	<b>197259</b>	<b>MH-BZ-80X</b>

# Solenoid valves MHP2, fast-switching valves

Peripherals overview – Semi in-line valve, 5/2-way valve

## Connection via plug vanes

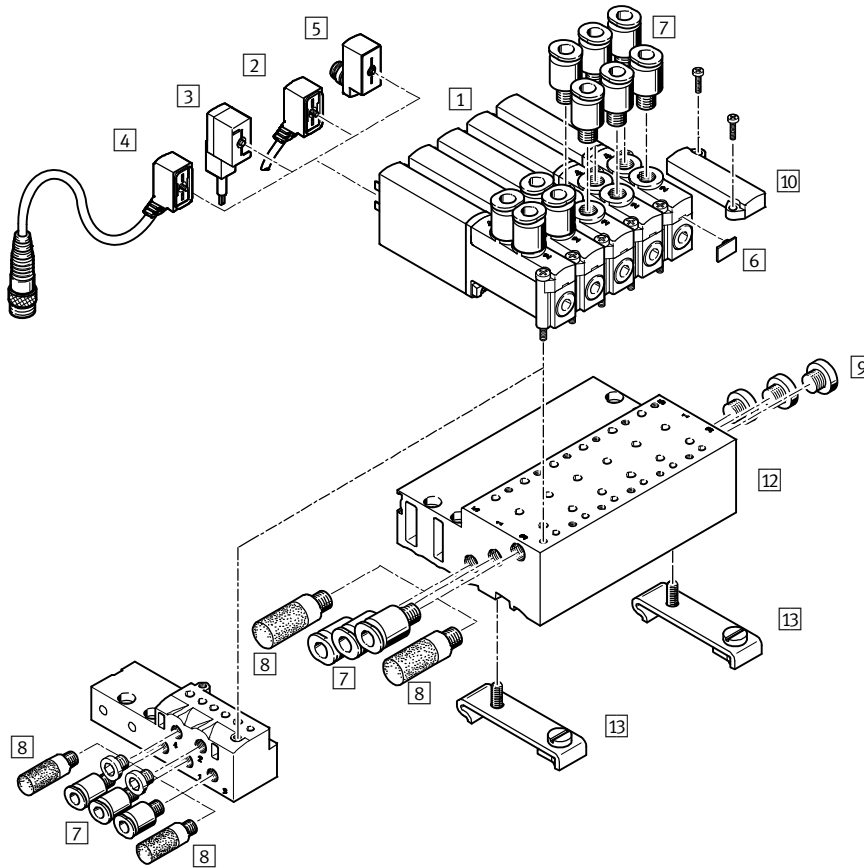

Designation	Brief description	→ Page/Internet
1 Semi in-line valve MHP2	With plug vanes	38
2 Connecting cable NEBV	PUR cable, signal status display with LED, IP65	38
3 Plug socket with cable KMYZ-4	PVC cable, without signal status display, IP50	38
4 Connecting cable NEBV	PUR cable, signal status display with LED, plug M8x1 3-pin, IP65	38
5 Adapter VAVE-C8	For connecting the valves via connecting cable M8 3-pin or 4-pin, IP65	38
6 Inscription label MH-BZ-80X	For identifying the valves	39
7 Push-in fittings QS	For connecting compressed air tubing with standard O.D.	39
8 Silencer UC	For mounting in exhaust ports	39
9 Blanking plug B	For sealing unused ports	39
10 Cover plate MHAP2-BP-5	For sealing vacant positions	38
11 Individual sub-base MHA2-AS-5-M5	For semi in-line valves, the individual sub-base is also used for sub-base valves and must be sealed with a blanking plug here	38
12 Manifold block MHP2-PR...-5	For semi in-line valves	38
13 H-rail mounting CPV10/14-VI-BG-NRH-35	For mounting the manifold block on H-rails according to EN 60715	38



# Solenoid valves MHP2, fast-switching valves

Technical data – Semi in-line valve, 5/2-way valves

Function

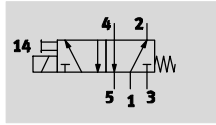

Voltage  
24 V DC



Pressure  
-0.9 ... +8 bar



Temperature range  
-5 ... +40 °C



General technical data		
Valve function		5/2-way, single solenoid
Design		Pressure-relieved poppet valve
Sealing principle		Soft
Reset method		Mechanical spring
Actuation type		Electric
Type of control		Direct
Direction of flow		Non-reversible
Exhaust function		With flow control
Manual override		Non-detenting
Mounting position		Any
Width	[mm]	10
Grid dimension	[mm]	14
Nominal width	[mm]	2
Standard nominal flow rate	[l/min]	90
Type of mounting		On PR rail
Tightening torque, valve mounting	[Nm]	Max. 0.4
Pneumatic connection	1, 3, 5	Sub-base
	2, 4	Connecting thread M5
Tightening torque for fitting	[Nm]	Max. 1.5
Product weight	[g]	70

Operating and environmental conditions		
Operating medium		Compressed air to ISO 8573-1:2010 [7:4:4]
Note on operating/pilot medium		Lubricated operation possible (in which case lubricated operation will always be required)
Operating pressure	[bar]	-0.9 ... +8
Ambient temperature	[°C]	-5 ... +40
Temperature of medium	[°C]	-5 ... +40
Restricted ambient and media temperature		As a function of switching frequency (see diagram)
Corrosion resistance class CRC <sup>1)</sup>		2
CE marking (see declaration of conformity)		To EU EMC Directive <sup>2)</sup>
Approval certificate		cULus Recognized (OL)
		RCM trademark

- 1) Corrosion resistance class 2 according to Festo standard 940 070  
Components subject to moderate corrosion stress. Externally visible parts with primarily decorative surface requirements which are in direct contact with a normal industrial environment or media such as coolants or lubricating agents.
- 2) For information about the applicability of the component see the manufacturer's EC declaration of conformity at: [www.festo.com/sp](http://www.festo.com/sp) → Certificates.  
If the component is subject to restrictions on usage in residential, office or commercial environments or small businesses, further measures to reduce the emitted interference may be necessary.

# Solenoid valves MHP2, fast-switching valves

Technical data – Semi in-line valve, 5/2-way valves

Electrical data			
Electrical connection		Plug, 2-pin	
Operating voltage		[V DC]	24 ±10%
Power consumption	Low-current phase	[W]	1.625
	High-current phase	[W]	6.5
Protection against incorrect polarity		Bipolar	
Additional functions		Spark arresting	
		Holding current reduction	
		Protective circuit	
Degree of protection to EN 60529	With connecting cable NEBV		IP65
	With plug socket with cable KMYZ-4		IP50
	With adapter VAVE-C8		IP65

Response times and switching frequencies			
Switching time	On	[ms]	1.9 +10% ... -30%
	Off	[ms]	1.7 +10% ... -30%
Maximum switching frequency		[Hz]	300 <sup>1)</sup>
Switching time variation at 1 Hz and above		[ms]	0.2

1) The ambient temperature must be limited with frequencies in excess of 75 Hz.

Safety data	
Resistance to shocks	Shock test with severity level 2 to FN 942017-5 and EN 60068-2-27
Vibration resistance	Transport application test with severity level 2 to FN 942017-4 and EN 60068-2-6

## Materials

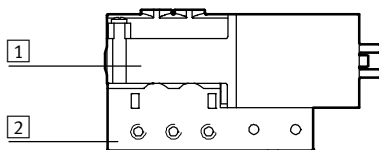

1	Housing	Die-cast zinc, coated
2	Sub-base	Die-cast zinc
-	Seals	HNBR, NBR
-	Screws	Galvanised steel
Note on materials		Free of copper and PTFE
		RoHS-compliant

# Solenoid valves MHP2, fast-switching valves

Technical data – Semi in-line valve, 5/2-way valves

## Restricted ambient and media temperature as a function of switching frequency

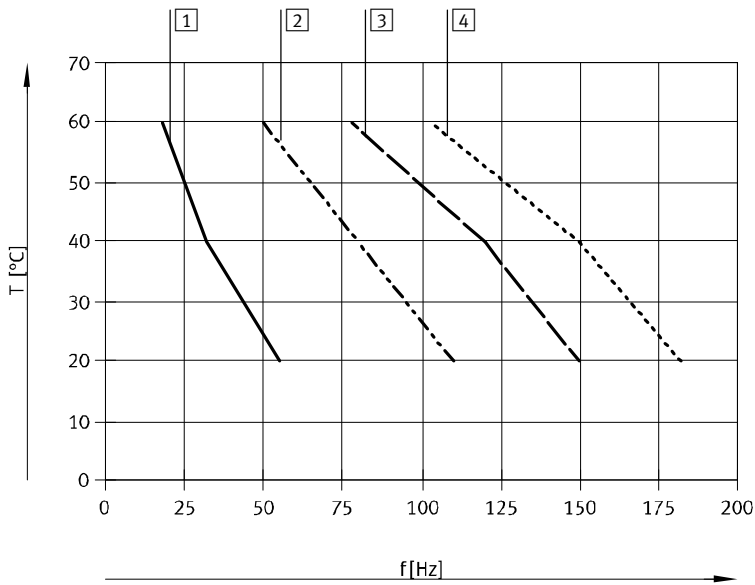

- 1 Manifold, 6 valves, pressureless
- 2 Manifold, 6 valves, flow through, 6 bar
- 3 Individual valve, pressureless
- 4 Individual valve, flow through, 6 bar

## Current curve for valves with fast-switching electronics (MHP2-MS1H)

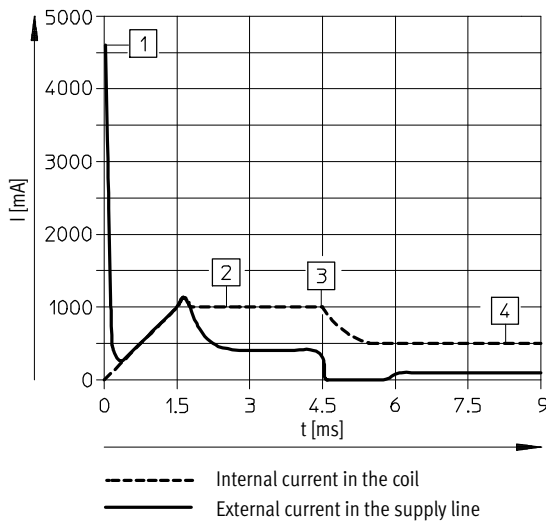

- 1 Capacitor charging
- 2 Controlled coil current 1 A
- 3 Reduction to holding current
- 4 Controlled holding current 0.5 A

# Solenoid valves MHP2, fast-switching valves

Technical data – Semi in-line valve, 5/2-way valves

## Dimensions

Download CAD data → [www.festo.com](http://www.festo.com)

Valve with plug vanes, MHP2-...-5/2...-M5

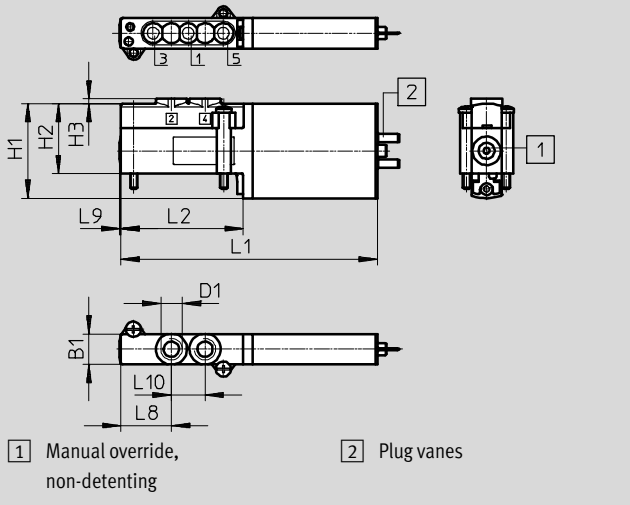

Hole pattern on sub-bases

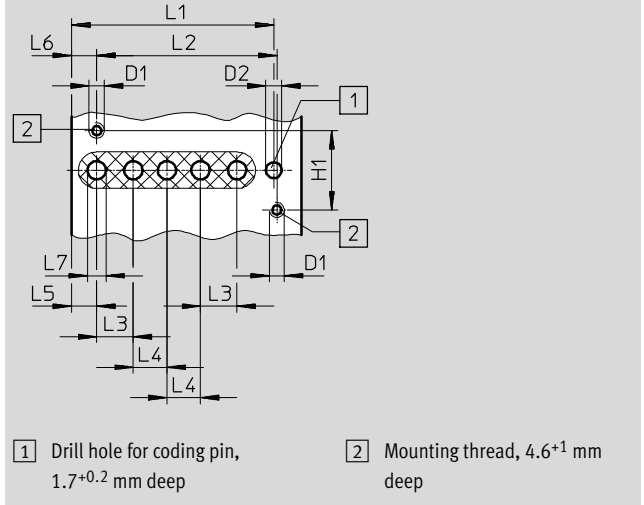

Type	B1	D1	D2 Ø	H1	H2	H3	H4	L1	L2	L3	L4	L5	L6	L7	L8	L9	L10
MHP2-...-5/2...-M5	10	M5	-	31	23	1.5	-	84	40	-	-	-	-	-	16.5	0.5	11
Hole pattern	-	M2.5	2.6	13	-	-	-	33.1	29.5	6	5.5	4.1	4.1	3	-	-	-

- - Note  
Semi in-line valves have no ports 2 and 4.

Individual sub-base, MHA2-AS-5-M5

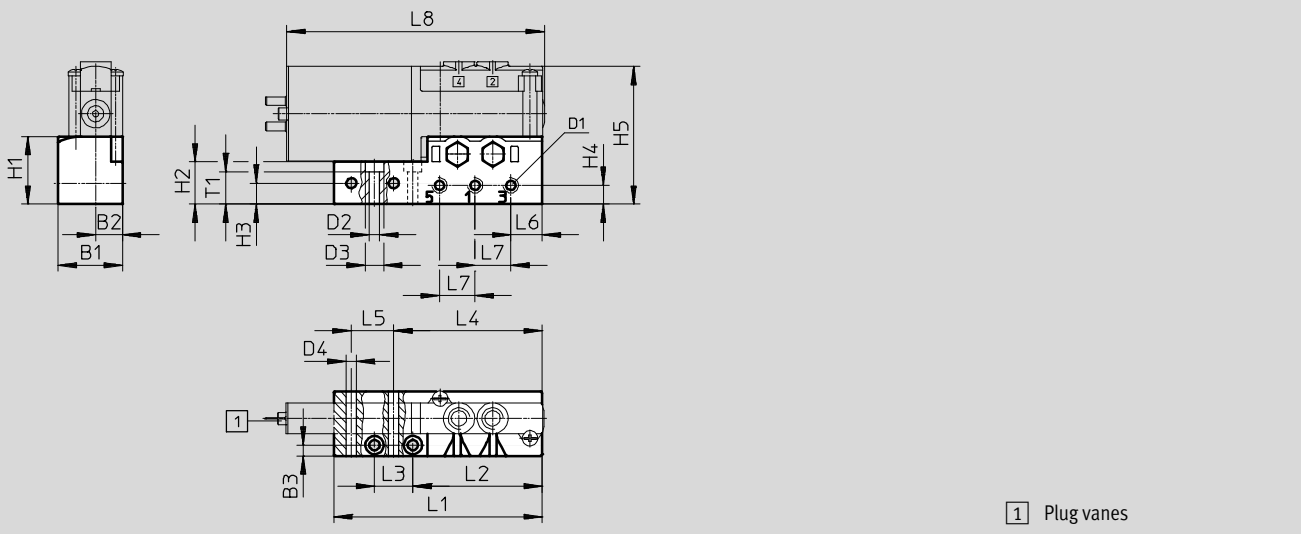

Type	B1	B2	B3	D1	D2 Ø	D3 Ø	D4 Ø	H1	H2	H3	H4	H5	L1	L2	L3	L4	L5	L6	L7	L8	T1
MHA2-AS-5-M5	21	8.8	3.5	M5	3.4	6	3.3	22.2	13.9	6.9	6.2	45.2	68.4	42.4	12.6	48.7	13.9	10.3	11.7	84.5	10.7

# Solenoid valves MHP2, fast-switching valves

Technical data – Semi in-line valve, 5/2-way valves

**Dimensions**

Download CAD data → [www.festo.com](http://www.festo.com)

Manifold assembly, MHP2-PR...-5

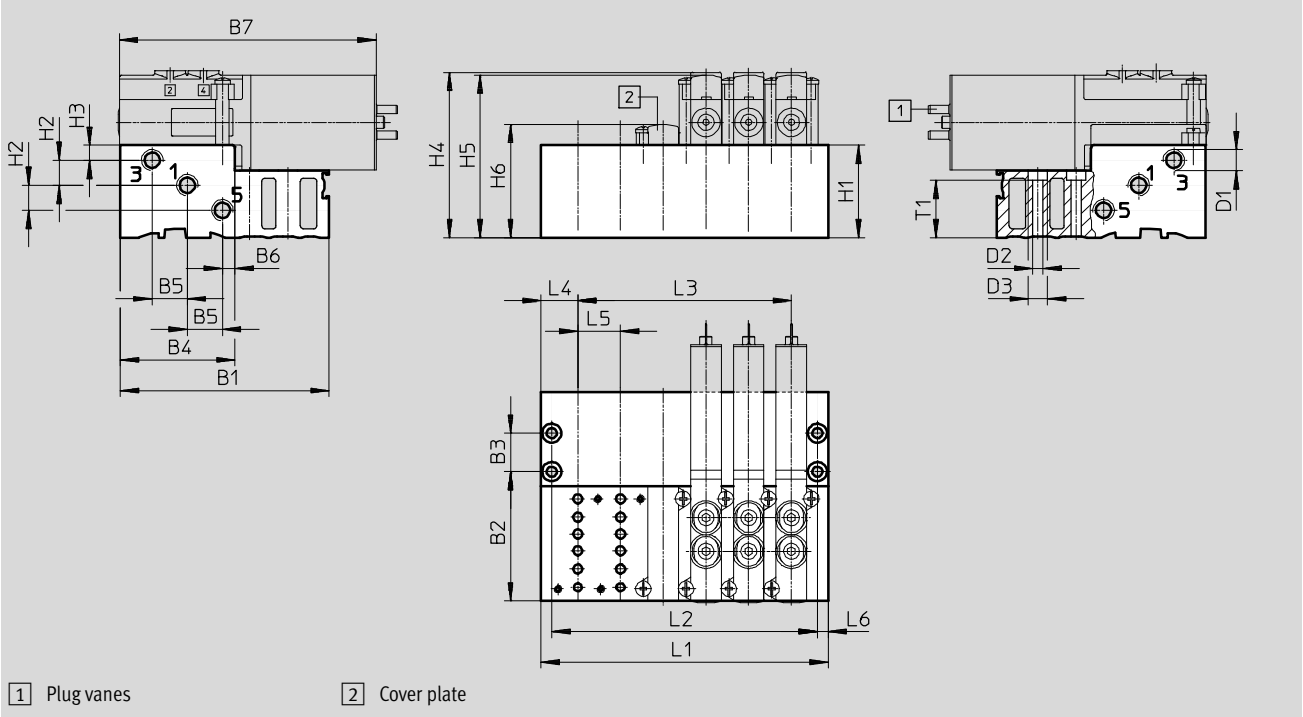







Type	B1	B2	B3	B4	B5	B6	B7	D1	D2 ∅	D3 ∅	H1	H2	H3	H4	H5	H6	L4	L5	L6	T1
MHP2-PR...-5	68.4	42.4	12.6	37.6	11.5	4.1	84	M7	3.3	6.3	30.3	8.2	4.9	54.8	53.3	37.1	12	14	3.5	18.8

Type	Number of valve positions					
		2	4	6	8	10
MHP2-PR...-5	L1	38	66	94	122	150
	L2	31	59	87	115	143
	L3	14	42	70	98	126

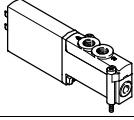
# Solenoid valves MHP2, fast-switching valves

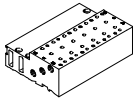
FESTO

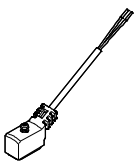
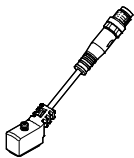

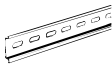

Technical data – Semi in-line valve, 5/2-way valve

Ordering data					Part No.	Type
<b>Valves</b>						
	With fast-switching electronics	Switching time on 1.9 ms			<b>525105</b>	<b>MHP2-MS1H-5/2-M5</b>
<b>Manifold rail</b>						
	Individual sub-base <sup>1)</sup> Pneumatic connection: thread M5	1 valve position	<b>525120</b>	<b>MHA2-AS-5-M5</b>		
	Manifold block Pneumatic connection 1, 3, 5: thread M7	2 valve positions	<b>525122</b>	<b>MHP2-PR2-5</b>		
		4 valve positions	<b>525123</b>	<b>MHP2-PR4-5</b>		
		6 valve positions	<b>525124</b>	<b>MHP2-PR6-5</b>		
		8 valve positions	<b>525125</b>	<b>MHP2-PR8-5</b>		
		10 valve positions	<b>525126</b>	<b>MHP2-PR10-5</b>		
<b>Cover plate</b>						
	Vacant valve positions must be sealed with a cover plate				<b>525132</b>	<b>MHAP2-BP-5</b>
<b>Connecting cable</b> <span style="float: right;">Technical data → Internet: nebv</span>						
	2-pin socket, open cable end 2-wire	PUR cable, degree of protection IP65	Signal status display with LED	2.5 m long	<b>8047671</b>	<b>NEBV-Z4WA2L-P-E-2.5-N-LE2-S1</b>
				5 m long	<b>8047672</b>	<b>NEBV-Z4WA2L-P-E-5-N-LE2-S1</b>
				10 m long	<b>8047670</b>	<b>NEBV-Z4WA2L-P-E-10-N-LE2-S1</b>
		PVC cable, degree of protection IP50	Without signal status display	0.5 m long	<b>193690</b>	<b>KMYZ-4-24-0,5-B</b>
2.5 m long	<b>193691</b>			<b>KMYZ-4-24-2,5-B</b>		
	2-pin socket, plug M8x1 3-pin	PUR, degree of protection IP65	Signal status display with LED	0.5 m long	<b>8047673</b>	<b>NEBV-Z4WA2L-P-E-0.5-N-M8G3-S1</b>
				2.5 m long	<b>8047674</b>	<b>NEBV-Z4WA2L-P-E-2.5-N-M8G3-S1</b>
<b>Adapter (for valves with plug vanes)</b>						
	2-pin socket	Signal status display with LED	Plug M8, 3-pin	<b>571686</b>	<b>VAVE-C8-1R8</b>	
			Plug M8, 4-pin	<b>573194</b>	<b>VAVE-C8-1R1</b>	
<b>H-rail mounting</b>						
	For 5/2-way solenoid valves				<b>162556</b>	<b>CPV10/14-VI-BG-NRH-35</b>
<b>H-rail</b>						
	To EN 60715			2 m	<b>35430</b>	<b>NRH-35-2000</b>

1) Seal ports 2 and 4 on the individual sub-base with blanking plugs. These ports have no function when using semi in-line valves.

# Solenoid valves MHP2, fast-switching valves

Technical data – Semi in-line valve, 5/2-way valve

Ordering data					
				Part No.	Type
Silencer <span style="float: right;">Technical data → Internet: uc</span>					
	With threaded connection	M5	1 piece	<b>165003</b>	<b>UC-M5</b>
			50 pieces	<b>534217</b>	<b>UC-M5-50</b>
		M7	1 piece	<b>161418</b>	<b>UC-M7</b>
			50 pieces	<b>534218</b>	<b>UC-M7-50</b>
Push-in fitting <span style="float: right;">Technical data → Internet: qs</span>					
	Male thread M5 with internal hex for tubing O.D.	4 mm	10 pieces	<b>153315</b>	<b>QSM-M5-4-I</b>
		6 mm	10 pieces	<b>153317</b>	<b>QSM-M5-6-I</b>
	Male thread M7 with internal hex for tubing O.D.	4 mm	10 pieces	<b>153319</b>	<b>QSM-M7-4-I</b>
			100 pieces	<b>133006</b>	<b>QSM-M7-4-I-100</b>
	Male thread M5 with external hex, push-in L-fitting rotatable through 360° for tubing O.D.	4 mm	10 pieces	<b>153333</b>	<b>QSML-M5-4</b>
			100 pieces	<b>130771</b>	<b>QSML-M5-4-100</b>
		6 mm	10 pieces	<b>153335</b>	<b>QSML-M5-6</b>
			100 pieces	<b>130772</b>	<b>QSML-M5-6-100</b>
	Male thread M7 with external hex, push-in L-fitting rotatable through 360° for tubing O.D.	4 mm	10 pieces	<b>186352</b>	<b>QSML-M7-4</b>
			100 pieces	<b>130773</b>	<b>QSML-M7-4-100</b>
		6 mm	10 pieces	<b>186353</b>	<b>QSML-M7-6</b>
			100 pieces	<b>130774</b>	<b>QSML-M7-6-100</b>
Blanking plug					
	For thread M5		10 pieces	<b>3843</b>	<b>B-M5</b>
	For thread M7		10 pieces	<b>174309</b>	<b>B-M7</b>
Inscription label					
	For solenoid valve		80 pieces in frame	<b>197259</b>	<b>MH-BZ-80X</b>

# Solenoid valves MHA2, fast-switching valves

Peripherals overview – Sub-base valve, 3/2-way valve

## Connection with plug vanes – Connection with moulded-in cable

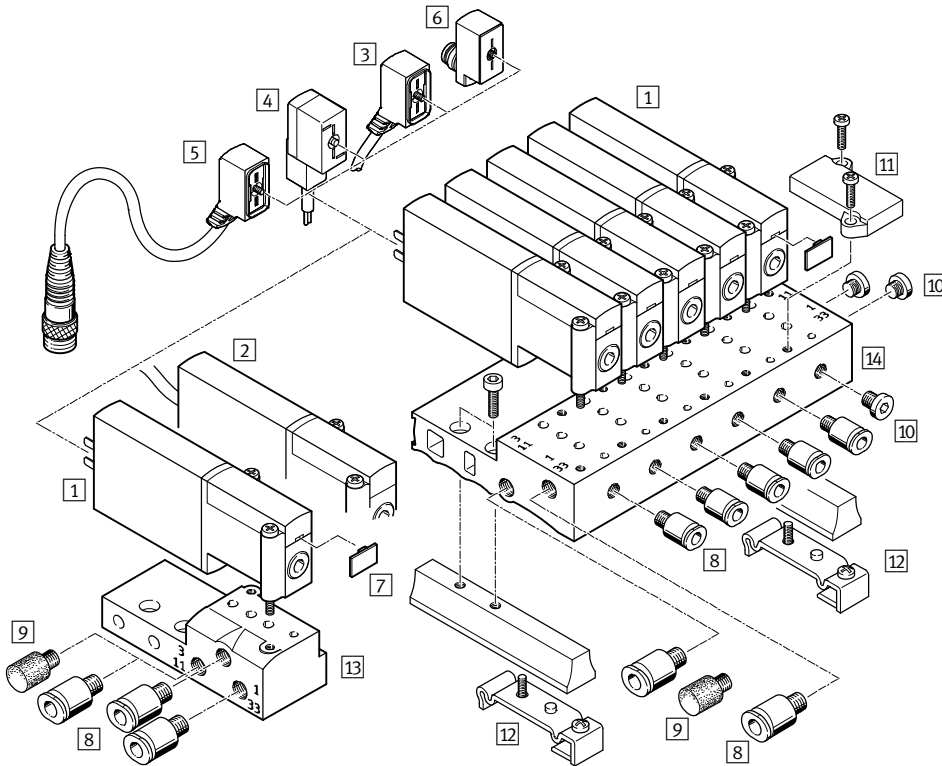

Designation	Brief description	→ Page/Internet
1 Sub-base valve MHA2	With plug vanes	47
2 Sub-base valve MHA2-...-K	With moulded-in cable	47
3 Connecting cable NEBV	PUR cable, signal status display with LED, IP65	47
4 Plug socket with cable KMYZ-4	PVC cable, without signal status display, IP50	47
5 Connecting cable NEBV	PUR cable, signal status display with LED, plug M8x1 3-pin, IP65	47
6 Adapter VAVE-C8	For connecting the valves via connecting cable M8 3-pin or 4-pin, IP65	48
7 Inscription label MH-BZ-80X	For identifying the valves	48
8 Push-in fittings QS	For connecting compressed air tubing with standard O.D.	48
9 Silencer UC	For mounting in exhaust ports	48
10 Blanking plug B	For sealing unused ports	48
11 Cover plate MHAP2-BP-3	For sealing vacant positions	47
12 H-rail mounting MHAP2-BG-NRH-35	For mounting the manifold block on H-rails according to EN 60715	48
13 Individual sub-base MHA2-AS-3-M5	For sub-base valve	47
14 Manifold block MHA2-PR-...-3-M5	For sub-base valve	47



# Solenoid valves MHA2, fast-switching valves

Technical data – Sub-base valve, 3/2-way valve

Function

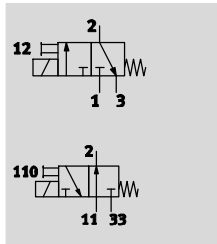

- - Voltage  
24 V DC
- - Pressure  
-0.9 ... +8 bar
- - Temperature range  
-5 ... +40 °C

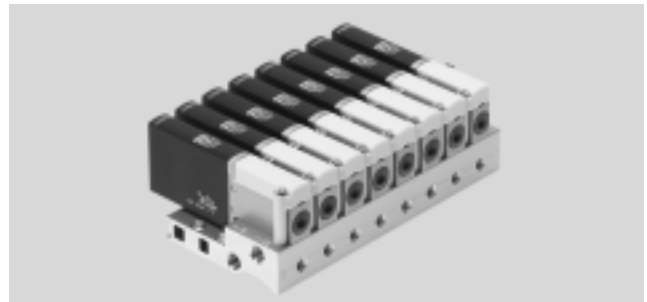

General technical data		
Valve function		3/2 way, single solenoid <sup>1)</sup>
Design		Pressure-relieved poppet valve
Sealing principle		Soft
Reset method		Mechanical spring
Actuation type		Electric
Type of control		Direct
Direction of flow		Non-reversible
Exhaust function		With flow control
Manual override		Non-detenting
Mounting position		Any
Width	[mm]	10
Grid dimension	[mm]	14
Nominal width	[mm]	2
Standard nominal flow rate	[l/min]	100
Type of mounting		On sub-base
Pneumatic connection		Sub-base
Product weight	[g]	60

1) Can be used as a 2/2-way valve by sealing port 3 or 33

Operating and environmental conditions			
		With fast-switching electronics	Without fast-switching electronics
Operating medium		Compressed air to ISO 8573-1:2010 [7:4:4]	
Note on operating/pilot medium		Lubricated operation possible (in which case lubricated operation will always be required)	
Operating pressure	[bar]	-0.9 ... +8	
	Reversible [bar]	-0.9 ... +1	
Ambient temperature	[°C]	-5 ... +40	
Temperature of medium	[°C]	-5 ... +40	
Restricted ambient and media temperature		As a function of switching frequency (see diagram)	
Corrosion resistance class CRC <sup>1)</sup>		2	
CE marking (see declaration of conformity)		To EU EMC Directive <sup>2)</sup>	-
Certification		c UL us Recognized (OL)	c UL us Recognized (OL)
		RCM trademark	-

1) Corrosion resistance class 2 according to Festo standard 940 070  
Components subject to moderate corrosion stress. Externally visible parts with primarily decorative surface requirements which are in direct contact with a normal industrial environment or media such as coolants or lubricating agents.

2) For information about the applicability of the component see the manufacturer's EC declaration of conformity at: [www.festo.com/sp](http://www.festo.com/sp) → Certificates.  
If the component is subject to restrictions on usage in residential, office or commercial environments or small businesses, further measures to reduce the emitted interference may be necessary.

# Solenoid valves MHA2, fast-switching valves

FESTO

Technical data – Sub-base valve, 3/2-way valve

Electrical data		With fast-switching electronics	Without fast-switching electronics
Electrical connection		2-pin plug or moulded-in cable	
Operating voltage	[V DC]	24 ±10%	
Power consumption	[W]	5 for approx. 3 ms (high-current phase, pick-up current 1 A)	2.88
	[W]	1.25 (low-current phase)	–
Protection against incorrect polarity		Bipolar	–
Additional functions		Spark arresting	–
		Holding current reduction	–
		Protective circuit	–
Degree of protection to EN 60529	With moulded-in cable	IP65	IP65
	With connecting cable NEBV	IP65	IP65
	With plug socket with cable KMYZ-4	IP50	IP50
	With adapter VAVE-C8	IP65	IP65

Response times and switching frequencies				With fast-switching electronics	Without fast-switching electronics
Switching time	On	[ms]		1.7 +10% ... –30%	7
	Off	[ms]		2 +10% ... –30%	3.5
Switching time variation at 1 Hz and above		[ms]		0.2	–
Maximum switching frequency		[Hz]		330 <sup>1)</sup>	130

1) The ambient temperature must be limited with frequencies in excess of 100 Hz.

Safety data	
Resistance to shocks	Shock test with severity level 2 to FN 942017-5 and EN 60068-2-27
Vibration resistance	Transport application test with severity level 2 to FN 942017-4 and EN 60068-2-6

## Materials

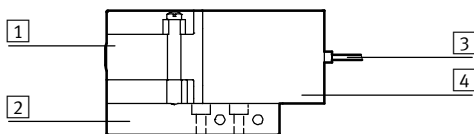

1	Housing	Die-cast zinc, coated
2	Sub-base	Aluminium in the case of the manifold, die-cast zinc in the case of the individual sub-base
3	Cable sheath	PUR
4	Coil housing	PA
–	Seals	HNBR, NBR
–	Screws	Galvanised steel
	Note on materials	Free of copper and PTFE RoHS-compliant <sup>1)</sup>

1) Not RoHS-compliant: MHA2-MS1H-3/2G-2, MHA2-MS1H-3/2G-2-K, MHA2-M1H-3/2O-2-K

# Solenoid valves MHA2, fast-switching valves

Technical data – Sub-base valve, 3/2-way valve

## Restricted ambient and media temperature as a function of switching frequency

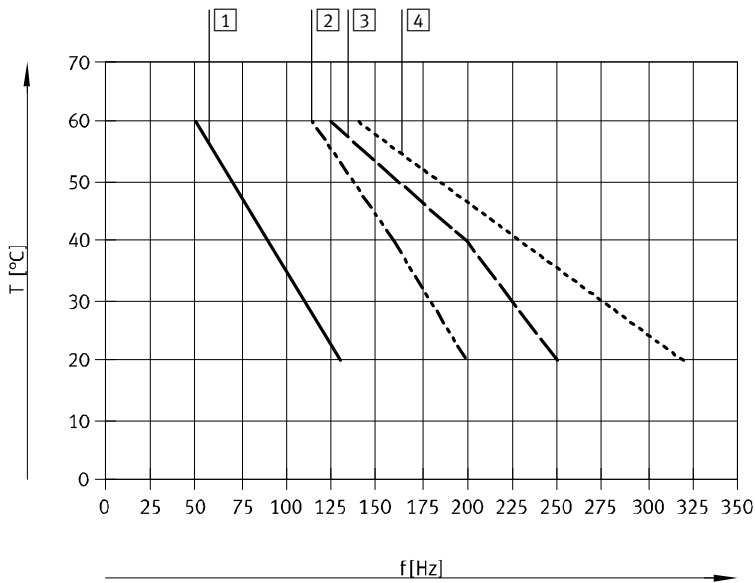

- 1 Manifold, 6 valves, pressureless
- 2 Manifold, 6 valves, flow through, 6 bar
- 3 Individual valve, pressureless
- 4 Individual valve, flow through, 6 bar

## Current curve for valves with fast-switching electronics (MHA2-MS1H)

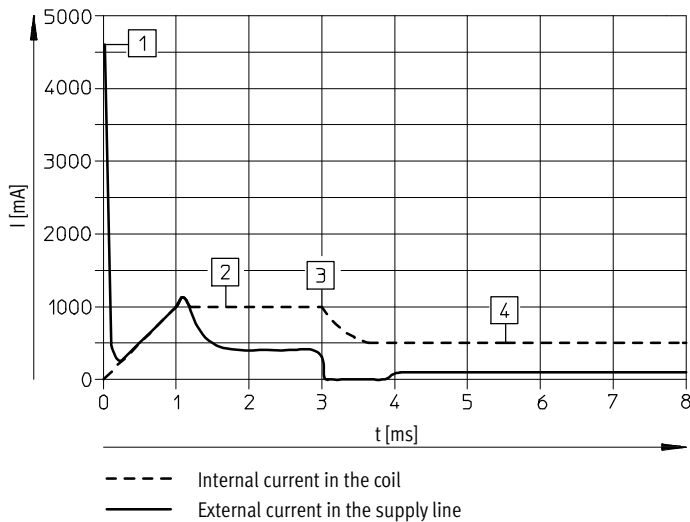

- 1 Capacitor charging
- 2 Controlled coil current 1 A
- 3 Reduction to holding current
- 4 Controlled holding current 0.5 A

# Solenoid valves MHA2, fast-switching valves

Technical data – Sub-base valve, 3/2-way valve

## Dimensions

Download CAD data → [www.festo.com](http://www.festo.com)

Valve with plug vanes or moulded-in cable, MHA2-...-3/2...

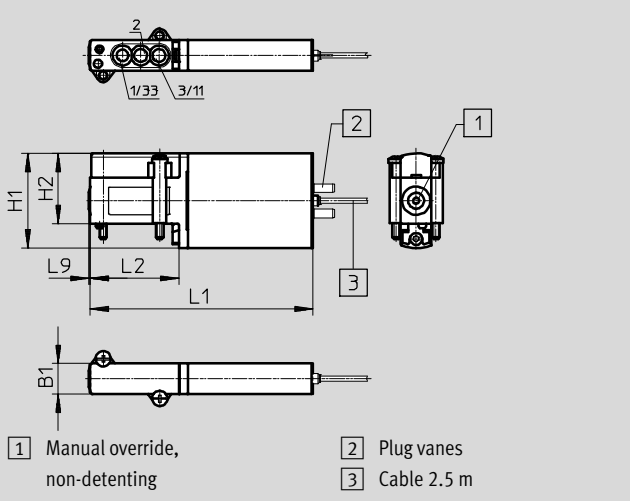

Hole pattern on sub-bases

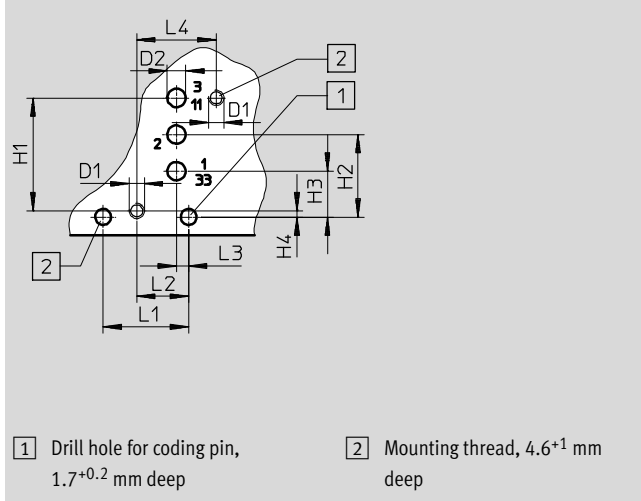

Type	B1	D1	D2 Ø	H1	H2	H3	H4	L1	L2	L3	L4	L9
MHA2-...-3/2...	10	-	-	31	23	-	-	73	29	-	-	0.5
Hole pattern	-	M2.5	3	18.5	13.5	7.5	1	14	8.5	2	13	-

# Solenoid valves MHA2, fast-switching valves

Technical data – Sub-base valve, 3/2-way valve

## Dimensions

Download CAD data → [www.festo.com](http://www.festo.com)

Individual sub-base, MHA2-AS-3-M5

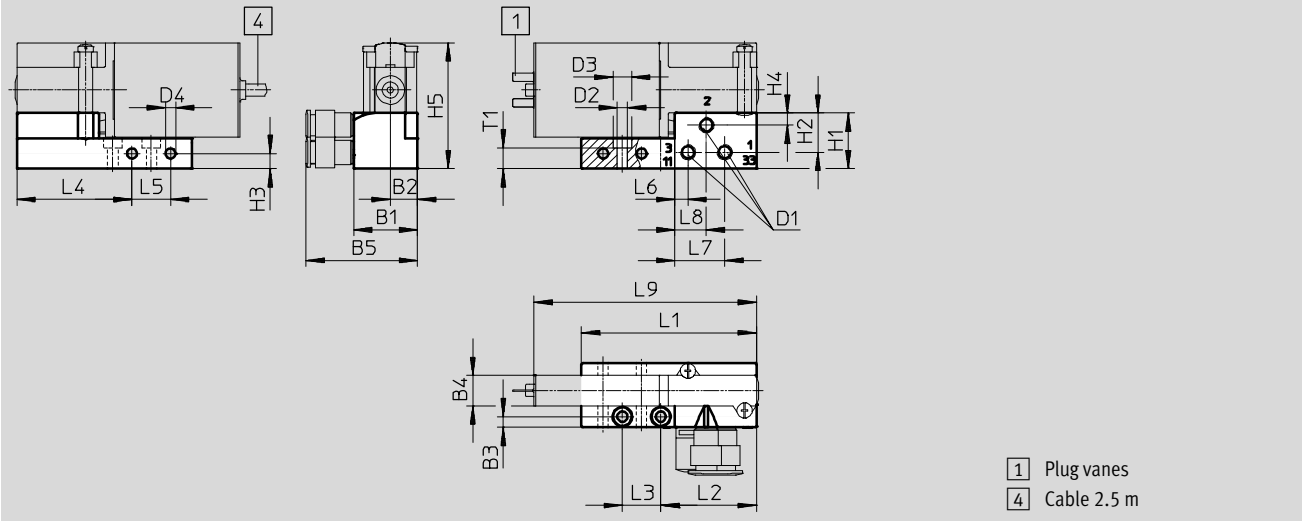

H-rail mounting MHAP2-BG-NRH-35

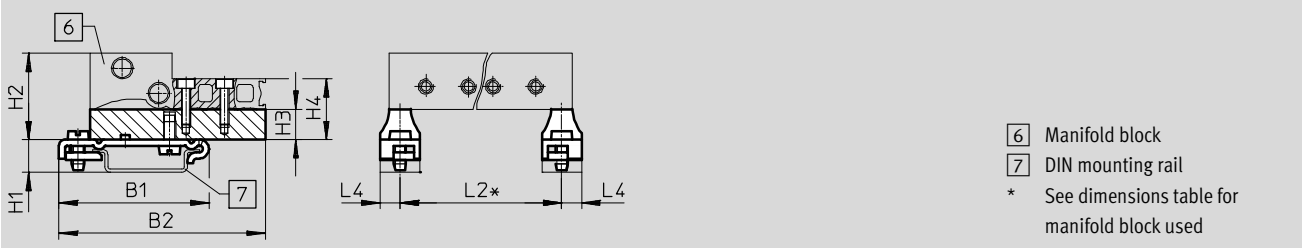

Type	B1	B2	B3	B4	B5	D1	D2	D3	D4	H1	H2	H3	H4	H5
MHA2-AS-3-M5	21	9	3.5	10	36.6	M5	3.4	6	3.3	18.3	12.9	5	4	41.3
MHAP2-BG-NRH-35	49.1	67.6	-	-	-	-	-	-	-	10.7	28.3	10	20	20

Type	L1	L2	L3	L4	L5	L6	L7	L8	L9	T1
MHA2-AS-3-M5	57.4	31.4	12.6	37.7	12.6	4.3	16.3	10.3	73	6.8
MHAP2-BG-NRH-35	-	*	-	6.5	-	-	-	-	-	-

\* See dimensions table for manifold block used

# Solenoid valves MHA2, fast-switching valves

Technical data – Sub-base valve, 3/2-way valve

## Dimensions

Download CAD data → [www.festo.com](http://www.festo.com)

Manifold assembly, MHA2-PR...-3-M5

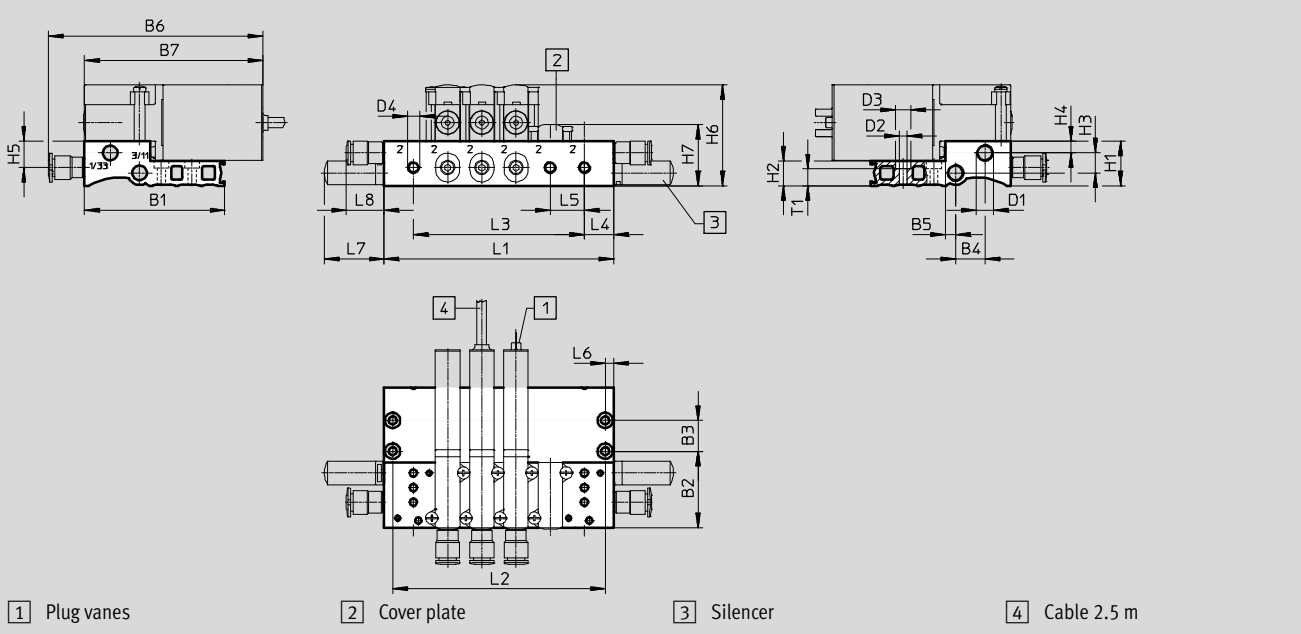

Type	B1	B2	B3	B4	B5	B6	B7	D1	D2	D3	D4	H1	H2	H3	H4	H5	H6	H7
MHP2-PR...-3-M5	57.4	31.4	12.6	12	4.3	87.9	73	M7	3.3	6.3	M5	18.3	10	8.2	4.9	10.9	41.3	25.1

Type	L4	L5	L6	L7	L8	T1
MHP2-PR...-3-M5	12	14	3.5	24.5	15.4	6.8





Type		Number of valve positions				
		2	4	6	8	10
MHP2-PR...-3-M5	L1	38	66	94	122	150
	L2	31	59	87	115	143
	L3	14	42	70	98	126

-  - Note

Valve types 3/2G and 3/2O must not be mixed on one manifold block.

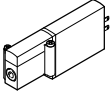
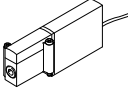
# Solenoid valves MHA2, fast-switching valves

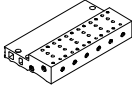
Technical data – Sub-base valve, 3/2-way valve

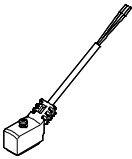
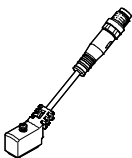
Ordering data						
					Part No.	Type
<b>Valves</b>						
	Electrical connection: plug vanes	With fast-switching electronics, switching time 2 ms	Normally open	<b>196139</b>	<b>MHA2-MS1H-3/20-2</b>	
			Normally closed	<b>196119</b>	<b>MHA2-MS1H-3/2G-2<sup>1)</sup></b>	
		Without fast-switching electronics, switching time 7 ms	Normally open	<b>196138</b>	<b>MHA2-M1H-3/20-2</b>	
			Normally closed	<b>196118</b>	<b>MHA2-M1H-3/2G-2</b>	
	Electrical connection: cable	With fast-switching electronics, switching time 2 ms	Normally open	<b>196141</b>	<b>MHA2-MS1H-3/20-2-K</b>	
			Normally closed	<b>196121</b>	<b>MHA2-MS1H-3/2G-2-K<sup>1)</sup></b>	
		Without fast-switching electronics, switching time 7 ms	Normally open	<b>196140</b>	<b>MHA2-M1H-3/20-2-K<sup>1)</sup></b>	
			Normally closed	<b>196120</b>	<b>MHA2-M1H-3/2G-2-K</b>	
<b>Manifold rail</b>						
	Individual sub-base Pneumatic connection: thread M5	1 valve position		<b>197438</b>	<b>MHA2-AS-3-M5</b>	
			Manifold block Pneumatic connection 1, 11, 3, 33: thread M7 Pneumatic connection 2: thread M5	2 valve positions		<b>197447</b>
4 valve positions				<b>197448</b>	<b>MHA2-PR4-3-M5</b>	
6 valve positions				<b>197449</b>	<b>MHA2-PR6-3-M5</b>	
8 valve positions				<b>197450</b>	<b>MHA2-PR8-3-M5</b>	
10 valve positions				<b>197451</b>	<b>MHA2-PR10-3-M5</b>	
<b>Cover plate</b>						
	Vacant valve positions must be sealed with a cover plate				<b>197470</b>	<b>MHAP2-BP-3</b>
<b>Connecting cable</b> <span style="float: right;">Technical data → Internet: nebv</span>						
	2-pin socket, open cable end 2-wire	PUR cable, degree of protection IP65	Signal status display with LED	2.5 m long	<b>8047671</b>	<b>NEBV-Z4WA2L-P-E-2.5-N-LE2-S1</b>
				5 m long	<b>8047672</b>	<b>NEBV-Z4WA2L-P-E-5-N-LE2-S1</b>
				10 m long	<b>8047670</b>	<b>NEBV-Z4WA2L-P-E-10-N-LE2-S1</b>
		PVC cable, degree of protection IP50	Without signal status display	0.5 m long	<b>193690</b>	<b>KMYZ-4-24-0,5-B</b>
2.5 m long	<b>193691</b>			<b>KMYZ-4-24-2,5-B</b>		
	2-pin socket, plug M8x1 3-pin	PUR cable, degree of protection IP65	Signal status display with LED	0.5 m long	<b>8047673</b>	<b>NEBV-Z4WA2L-P-E-0.5-N-M8G3-S1</b>
				2.5 m long	<b>8047674</b>	<b>NEBV-Z4WA2L-P-E-2.5-N-M8G3-S1</b>







1) Not RoHS-compliant

 Note  
Valve types 3/2G and 3/2O must not be mixed on one manifold block.

# Solenoid valves MHA2, fast-switching valves

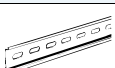
FESTO

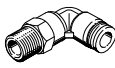
Technical data – Sub-base valve, 3/2-way valve

Ordering data				Part No.	Type
Adapter (for valves with plug vanes)					
	2-pin socket	Signal status display with LED	Plug M8, 3-pin	<b>571686</b>	<b>VAVE-C8-1R8</b>
			Plug M8, 4-pin	<b>573194</b>	<b>VAVE-C8-1R1</b>
H-rail mounting					
	For 3/2-way solenoid valves			<b>525053</b>	<b>MHAP2-BG-NRH-35</b>
H-rail					
	To EN 60715		2 m	<b>35430</b>	<b>NRH-35-2000</b>
Silencer				Technical data → Internet: uc	
	With threaded connection	M5	1 piece	<b>165003</b>	<b>UC-M5</b>
			50 pieces	<b>534217</b>	<b>UC-M5-50</b>
		M7	1 piece	<b>161418</b>	<b>UC-M7</b>
			50 pieces	<b>534218</b>	<b>UC-M7-50</b>
Push-in fitting				Technical data → Internet: qs	
	Male thread M5 with internal hex for tubing O.D.	4 mm	10 pieces	<b>153315</b>	<b>QSM-M5-4-I</b>
		6 mm	10 pieces	<b>153317</b>	<b>QSM-M5-6-I</b>
	Male thread M7 with internal hex for tubing O.D.	4 mm	10 pieces	<b>153319</b>	<b>QSM-M7-4-I</b>
			100 pieces	<b>133006</b>	<b>QSM-M7-4-I-100</b>
	Male thread M5 with external hex, push-in L-fitting rotatable through 360° for tubing O.D.	4 mm	10 pieces	<b>153333</b>	<b>QSML-M5-4</b>
			100 pieces	<b>130771</b>	<b>QSML-M5-4-100</b>
		6 mm	10 pieces	<b>153335</b>	<b>QSML-M5-6</b>
	Male thread M7 with external hex, push-in L-fitting rotatable through 360° for tubing O.D.	4 mm	10 pieces	<b>130772</b>	<b>QSML-M5-6-100</b>
			100 pieces	<b>186352</b>	<b>QSML-M7-4</b>
		6 mm	10 pieces	<b>130773</b>	<b>QSML-M7-4-100</b>
	100 pieces	<b>186353</b>	<b>QSML-M7-6</b>		
	100 pieces	<b>130774</b>	<b>QSML-M7-6-100</b>		
Blanking plug					
	For thread M5		10 pieces	<b>3843</b>	<b>B-M5</b>
	For thread M7		10 pieces	<b>174309</b>	<b>B-M7</b>
Inscription label					
	For solenoid valve		80 pieces in frame	<b>197259</b>	<b>MH-BZ-80X</b>



# Solenoid valves MHA2, fast-switching valves

Peripherals overview – Sub-base valve, 5/2-way valve

Connection with plug vanes – Connection with moulded-in cable

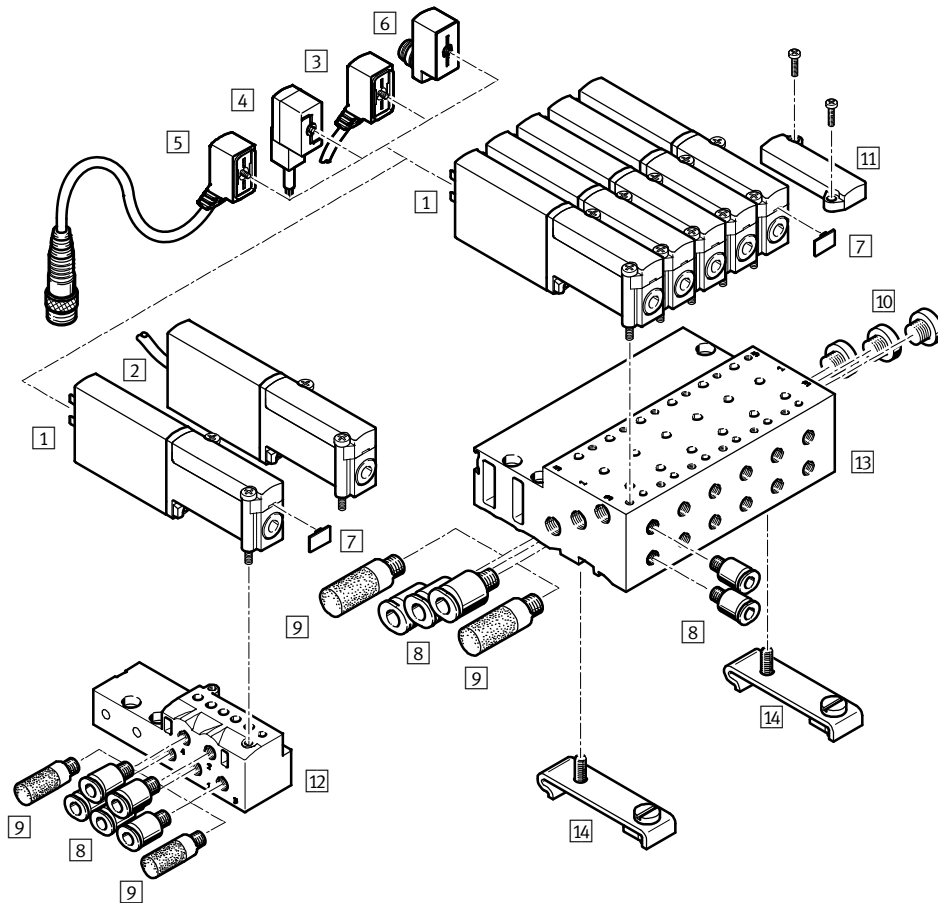

Designation	Brief description	→ Page/Internet
1 Sub-base valve MHA2	With plug vanes	55
2 Sub-base valve MHA2-...-K	With moulded-in cable	55
3 Connecting cable NEBV	PUR cable, signal status display with LED, IP65	55
4 Plug socket with cable KMYZ-4	PVC cable, signal switching status display, IP50	55
5 Connecting cable NEBV	PUR cable, signal status display with LED, plug M8x1 3-pin, IP65	55
6 Adapter VAVE-C8	For connecting the valves via connecting cable M8 3-pin or 4-pin, IP65	56
7 Inscription label MH-BZ-80X	For identifying the valves	56
8 Push-in fittings QS	For connecting compressed air tubing with standard O.D.	56
9 Silencer UC	For mounting in exhaust ports	56
10 Blanking plug B	For sealing unused ports	56
11 Cover plate MHAP2-BP-5	For sealing vacant positions	55
12 Individual sub-base MHA2-AS-5-M5	For sub-base valve	55
13 Manifold block MHA2-PR...-5-M5	For sub-base valve	55
14 H-rail mounting CPV10/14-VI-BG-NRH-35	For mounting the manifold block on H-rails according to EN 60715	56



# Solenoid valves MHA2, fast-switching valves

Technical data – Sub-base valve, 5/2-way valve

FESTO

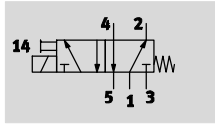
Function



-  - Voltage  
24 V DC
-  - Pressure  
-0.9 ... +8 bar
-  - Temperature range  
-5 ... +40 °C

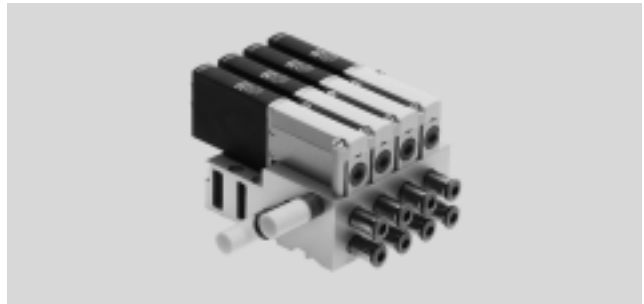

General technical data		
Valve function		5/2-way, single solenoid
Design		Pressure-relieved poppet valve
Sealing principle		Soft
Reset method		Mechanical spring
Actuation type		Electric
Type of control		Direct
Direction of flow		Reversible with restrictions <sup>1)</sup>
Exhaust air function		With flow control
Manual override		Non-detenting
Mounting position		Any
Width	[mm]	10
Grid dimension	[mm]	14
Nominal width	[mm]	2
Standard nominal flow rate	[l/min]	90
Type of mounting		On PR rail
Max. Tightening torque of valve mounting	[Nm]	0.4
Pneumatic connection		Sub-base
Product weight	[g]	70

1) Slight leakage can occur in the pressure range -0.8 bar to +0.5 bar.

Operating and environmental conditions		
Operating medium		Compressed air to ISO 8573-1:2010 [7:4:4]
Note on operating/pilot medium		Lubricated operation possible (in which case lubricated operation will always be required)
Operating pressure	[bar]	-0.9 ... +8
Ambient temperature	[°C]	-5 ... +40
Temperature of medium	[°C]	-5 ... +40
Restricted ambient and media temperature		As a function of switching frequency (see diagram)
Corrosion resistance class CRC <sup>1)</sup>		2
CE marking (see declaration of conformity)		To EU EMC Directive <sup>2)</sup>
Approval certificate		cULus Recognized (OL) RCM trademark

- 1) Corrosion resistance class 2 according to Festo standard 940 070  
Components subject to moderate corrosion stress. Externally visible parts with primarily decorative surface requirements which are in direct contact with a normal industrial environment or media such as coolants or lubricating agents.
- 2) For information about the applicability of the component see the manufacturer's EC declaration of conformity at: [www.festo.com/sp](http://www.festo.com/sp) → Certificates.  
If the component is subject to restrictions on usage in residential, office or commercial environments or small businesses, further measures to reduce the emitted interference may be necessary.

# Solenoid valves MHA2, fast-switching valves

Technical data – Sub-base valve, 5/2-way valve

Electrical data			
Electrical connection		2-pin plug or moulded-in cable	
Operating voltage		[V DC]	24 ±10%
Power consumption	Low-current phase	[W]	1.625
	High-current phase	[W]	6.5
Protection against incorrect polarity		Bipolar	
Additional functions		Spark arresting	
		Holding current reduction	
		Protective circuit	
Degree of protection to EN 60529	With moulded-in cable		IP65
	With connecting cable NEBV		IP65
	With plug socket with cable KMYZ-4		IP50
	With adapter VAVE-C8		IP65

Response times and switching frequencies			
Switching time	On	[ms]	1.9 +10% ... -30%
	Off	[ms]	1.7 +10% ... -30%
Maximum switching frequency		[Hz]	300 <sup>1)</sup>
Switching time variation at 1 Hz and above		[ms]	0.2

1) The ambient temperature must be limited with frequencies in excess of 125 Hz.

Safety data	
Resistance to shocks	Shock test with severity level 2 to FN 942017-5 and EN 60068-2-27
Vibration resistance	Transport application test with severity level 2 to FN 942017-4 and EN 60068-2-6

## Materials

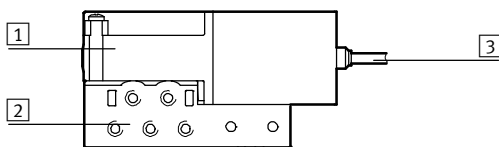

1	Housing	Die-cast zinc, coated
2	Sub-base	Die-cast zinc
3	Cable sheath	PUR
-	Seals	HNBR, NBR
-	Screws	Galvanised steel
Note on materials		Free of copper and PTFE
		RoHS-compliant

# Solenoid valves MHA2, fast-switching valves

Technical data – Sub-base valve, 5/2-way valve

## Restricted ambient and media temperature as a function of switching frequency

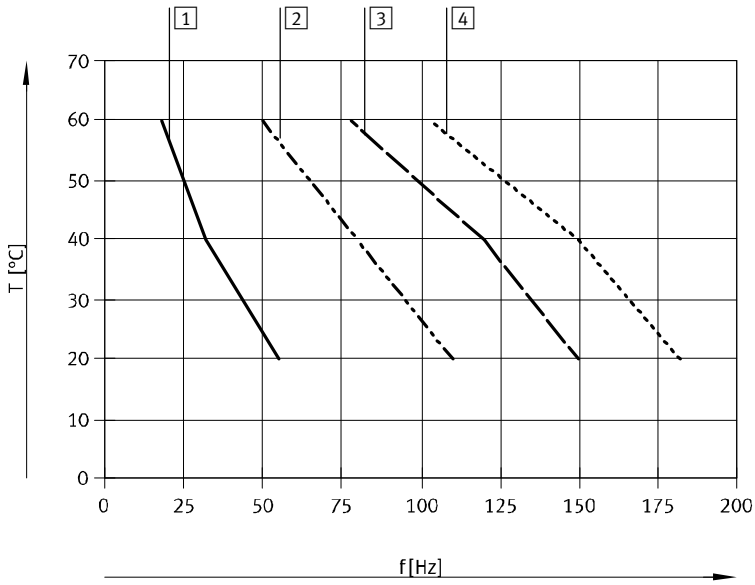

- 1 Manifold, 6 valves, pressureless
- 2 Manifold, 6 valves, flow through, 6 bar
- 3 Individual valve, pressureless
- 4 Individual valve, flow through, 6 bar

## Current curve for valves with fast-switching electronics (MHA2-MS1H)

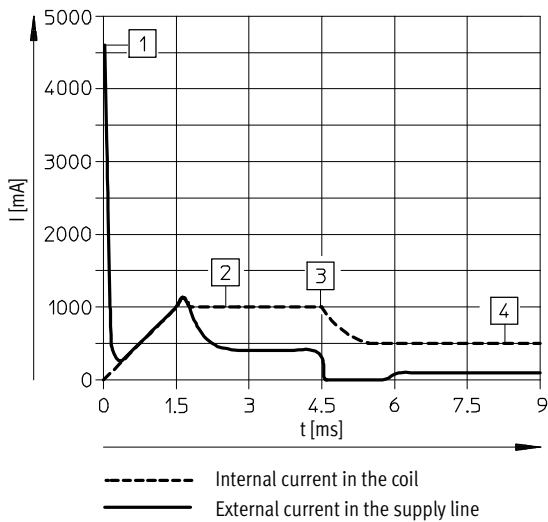

- 1 Capacitor charging
- 2 Controlled coil current 1 A
- 3 Reduction to holding current
- 4 Controlled holding current 0.5 A

# Solenoid valves MHA2, fast-switching valves

Technical data – Sub-base valve, 5/2-way valve

## Dimensions

Download CAD data → [www.festo.com](http://www.festo.com)

Valve with plug vanes or moulded-in cable, MHA2-...-5/2...

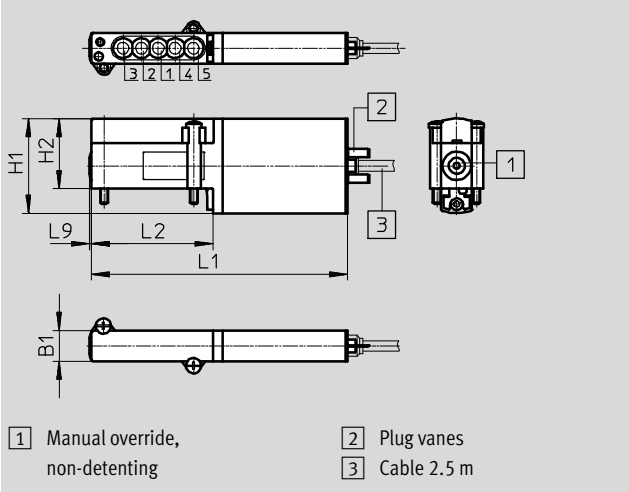

Hole pattern on sub-bases

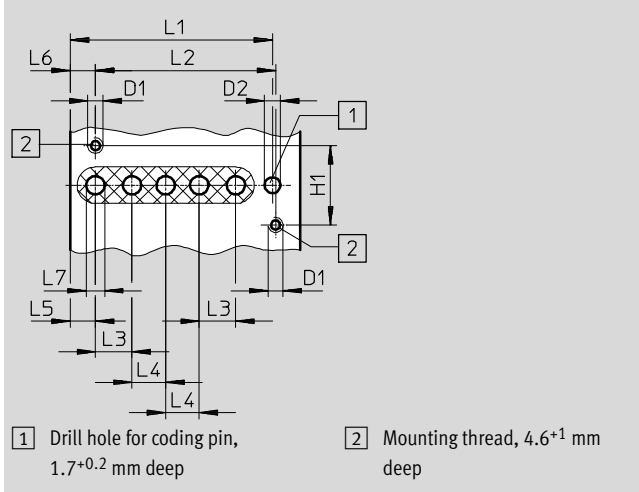

Type	B1	D1	D2 Ø	H1	H2	L1	L2	L3	L4	L5	L6	L7	L9
MHA2-...-5/2...	10	-	-	31	23	84	40	-	-	-	-	-	0.5
Hole pattern	-	M2.5	2.6	13	-	33.1	29.5	6	5.5	4.1	4.1	3	-

## Dimensions

Download CAD data → [www.festo.com](http://www.festo.com)

Individual sub-base, MHA2-AS-5-M5

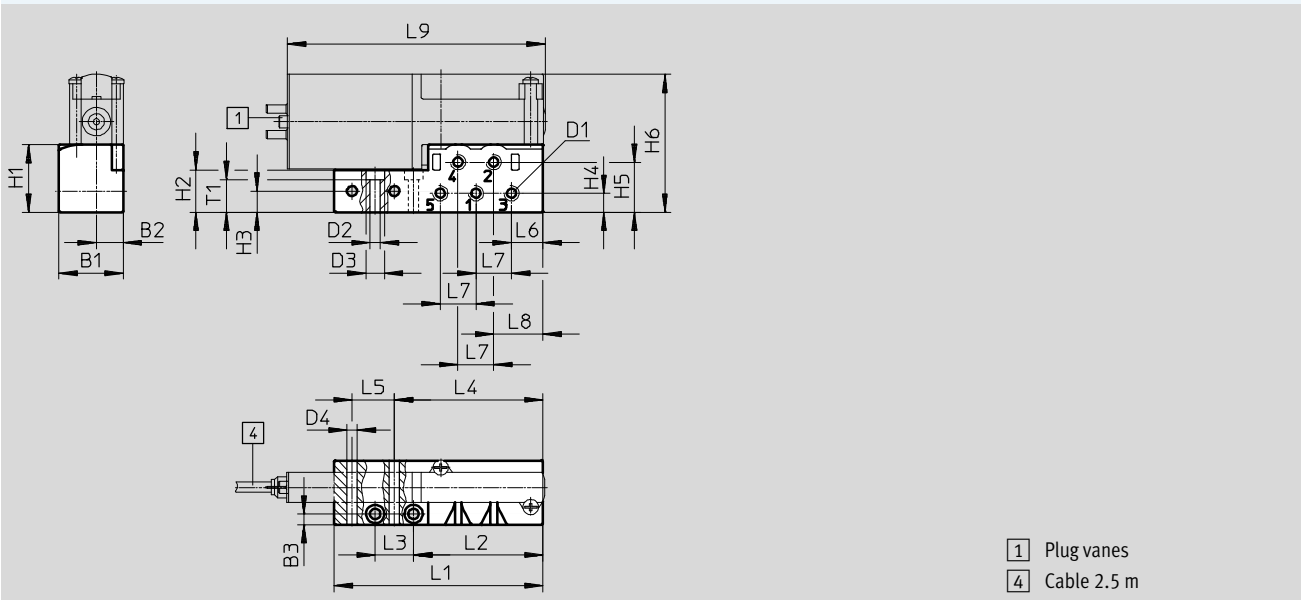

Type	B1	B2	B3	D1	D2 Ø	D3 Ø	D4 Ø	H1	H2	H3	H4	H5	H6
MHA2-AS-5-M5	21	8.8	3.5	M5	3.4	6	3.3	22.2	13.9	6.9	6.2	16.4	45.2

Type	L1	L2	L3	L4	L5	L6	L7	L8	L9	T1
MHA2-AS-5-M5	68.4	42.4	12.6	48.7	13.9	10.3	11.7	16.2	84.5	10.7

# Solenoid valves MHA2, fast-switching valves

Technical data – Sub-base valve, 5/2-way valves



## Dimensions

Download CAD data → [www.festo.com](http://www.festo.com)

Manifold assembly, MHA2-PR...-5-M5

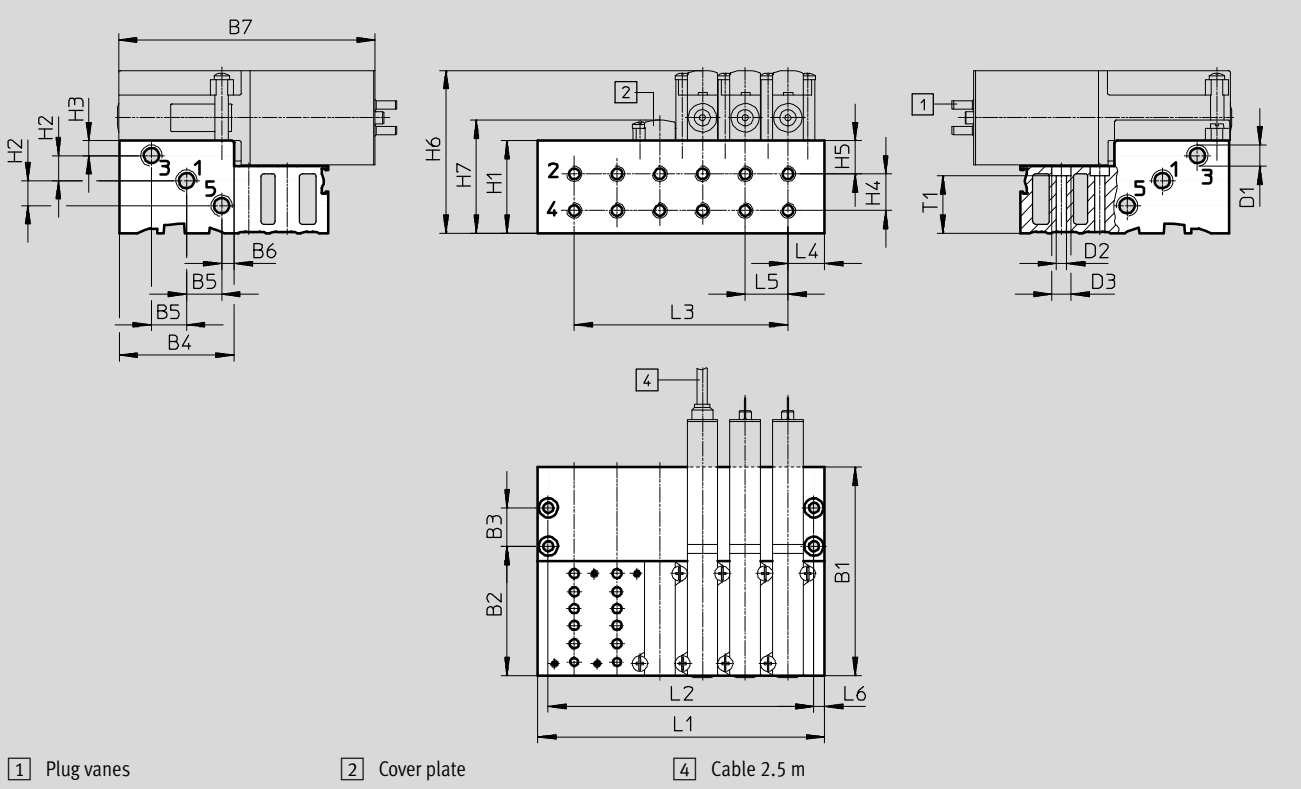





Type	B1	B2	B3	B4	B5	B6	B7	D1	D2	D3	H1	H2	H3	H4	H5	H6	H7	L4	L5	L6	T1
MHA2-PR...-5-M5	68.4	42.4	12.6	37.6	11.5	4.1	84	M7	3.3	6.3	30.3	8.2	4.9	12	10.9	53.3	37.1	12	14	3.5	18.8

Type		Number of valve positions				
		2	4	6	8	10
MHA2-PR...-5-M5	L1	38	66	94	122	150
	L2	31	59	87	115	143
	L3	14	42	70	98	126

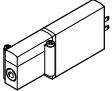
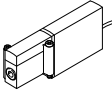
# Solenoid valves MHA2, fast-switching valves

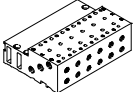

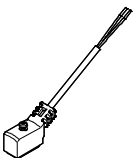
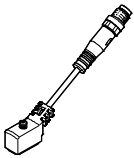



Technical data – Sub-base valve, 5/2-way valve

Ordering data				Part No.	Type	
<b>Valves</b>						
	Electrical connection: plug vanes	With fast-switching electronics, switching time 2 ms		<b>525101</b>	<b>MHA2-MS1H-5/2-2</b>	
	Electrical connection: cable	With fast-switching electronics, switching time 2 ms		<b>525103</b>	<b>MHA2-MS1H-5/2-2-K</b>	
<b>Manifold rail</b>						
	Individual sub-base Pneumatic connection: thread M5	1 valve position		<b>525120</b>	<b>MHA2-AS-5-M5</b>	
	Manifold block Pneumatic connection 1, 3, 5: thread M7 Pneumatic connection 2, 4: thread M5	2 valve positions		<b>525127</b>	<b>MHA2-PR2-5-M5</b>	
		4 valve positions		<b>525128</b>	<b>MHA2-PR4-5-M5</b>	
		6 valve positions		<b>525129</b>	<b>MHA2-PR6-5-M5</b>	
		8 valve positions		<b>525130</b>	<b>MHA2-PR8-5-M5</b>	
		10 valve positions		<b>525131</b>	<b>MHA2-PR10-5-M5</b>	
<b>Cover plate</b>						
	Vacant valve positions must be sealed with a cover plate			<b>197470</b>	<b>MHAP2-BP-3</b>	
<b>Connecting cable</b> <span style="float: right;">Technical data → Internet: nebv</span>						
	2-pin socket, open cable end 2-wire	PUR cable, degree of protection IP65	Signal status display with LED	2.5 m long	<b>8047671</b>	<b>NEBV-Z4WA2L-P-E-2.5-N-LE2-S1</b>
				5 m long	<b>8047672</b>	<b>NEBV-Z4WA2L-P-E-5-N-LE2-S1</b>
				10 m long	<b>8047670</b>	<b>NEBV-Z4WA2L-P-E-10-N-LE2-S1</b>
		PVC cable, degree of protection IP50	Without signal status display	0.5 m long	<b>193690</b>	<b>KMYZ-4-24-0,5-B</b>
				2.5 m long	<b>193691</b>	<b>KMYZ-4-24-2,5-B</b>
	2-pin socket, plug M8x1 3-pin	PUR cable, degree of protection IP65	Signal status display with LED	0.5 m long	<b>8047673</b>	<b>NEBV-Z4WA2L-P-E-0.5-N-M8G3-S1</b>
				2.5 m long	<b>8047674</b>	<b>NEBV-Z4WA2L-P-E-2.5-N-M8G3-S1</b>

# Solenoid valves MHA2, fast-switching valves

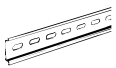
FESTO

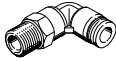
Technical data – Sub-base valve, 5/2-way valve

Ordering data				Part No.	Type
Adapter (for valves with plug vanes)					
	2-pin socket	Signal status display with LED	Plug M8, 3-pin	<b>571686</b>	<b>VAVE-C8-1R8</b>
			Plug M8, 4-pin	<b>573194</b>	<b>VAVE-C8-1R1</b>
H-rail mounting					
	For 5/2-way solenoid valves			<b>162556</b>	<b>CPV10/14-VI-BG-NRH-35</b>
H-rail					
	To EN 60715		2 m	<b>35430</b>	<b>NRH-35-2000</b>
Silencer				Technical data → Internet: uc	
	With threaded connection	M5	1 piece	<b>165003</b>	<b>UC-M5</b>
			50 pieces	<b>534217</b>	<b>UC-M5-50</b>
		M7	1 piece	<b>161418</b>	<b>UC-M7</b>
			50 pieces	<b>534218</b>	<b>UC-M7-50</b>
Push-in fitting				Technical data → Internet: qs	
	Male thread M5 with internal hex for tubing O.D.	4 mm	10 pieces	<b>153315</b>	<b>QSM-M5-4-I</b>
		6 mm	10 pieces	<b>153317</b>	<b>QSM-M5-6-I</b>
	Male thread M7 with internal hex for tubing O.D.	4 mm	10 pieces	<b>153319</b>	<b>QSM-M7-4-I</b>
			100 pieces	<b>133006</b>	<b>QSM-M7-4-I-100</b>
	Male thread M5 with external hex, push-in L-fitting rotatable through 360° for tubing O.D.	4 mm	10 pieces	<b>153333</b>	<b>QSML-M5-4</b>
			100 pieces	<b>130771</b>	<b>QSML-M5-4-100</b>
		6 mm	10 pieces	<b>153321</b>	<b>QSML-M7-6-I</b>
	Male thread M7 with external hex, push-in L-fitting rotatable through 360° for tubing O.D.	4 mm	10 pieces	<b>186352</b>	<b>QSML-M7-4</b>
			100 pieces	<b>130773</b>	<b>QSML-M7-4-100</b>
		6 mm	10 pieces	<b>186353</b>	<b>QSML-M7-6</b>
		100 pieces	<b>130774</b>	<b>QSML-M7-6-100</b>	
Blanking plug					
	For thread M5		10 pieces	<b>3843</b>	<b>B-M5</b>
	For thread M7		10 pieces	<b>174309</b>	<b>B-M7</b>
Inscription label					
	For solenoid valve		80 pieces in frame	<b>197259</b>	<b>MH-BZ-80X</b>



# Solenoid valves MH3, fast-switching valves

Type codes

MH E 3 - M S 1 H - 3/2 - G - QS-6 K

**Valve series**

MH	Fast-switching valves
----	-----------------------

**Design**

E	Individual valve
P	Semi in-line valve
A	Sub-base valve

**Size**

3	Flow rate 200 l/min
---	---------------------

**Drive system**

M	Solenoid, switching
---	---------------------

**Switching time**

-	8.3 ms
S	3 ms

**Operating voltage**

1	24 V DC
---	---------

**Manual override**

H	Non-detenting
---	---------------

**Valve function**

3/2	3/2-way valve
-----	---------------

**Normal position**

G	Closed
0	Open

**Pneumatic connection**

3	Sub-base, nominal width 3 mm
1/8	Thread G1/8
QS-6	Push-in connector for tubing O.D. 6 mm

**Electrical connection**

-	Plug vanes with connection pattern ZC
K	Moulded-in cable, 2.5 m long

# Solenoid valves MHE3, fast-switching valves

Peripherals overview – Individual valve

Connection with plug vanes – Connection with moulded-in cable

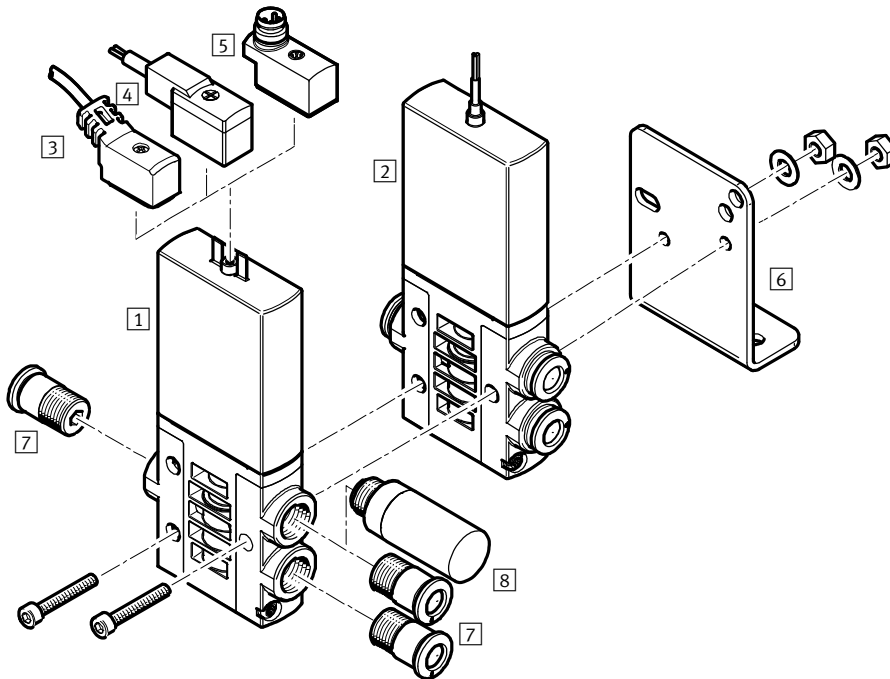

Designation	Brief description	→ Page/Internet
1 Individual valve MHE3	With plug vanes	63
2 Individual valve MHE3-...-K	With cable	63
3 Connecting cable NEBV	PUR cable, signal status display with LED, IP65	64
4 Plug socket with cable KMYZ-4	PVC cable, without signal status display, IP50	64
5 Adapter VAVE-C8	For connecting the valves via connecting cable M8 3-pin or 4-pin, IP65	64
6 Mounting bracket MHE2-BG-L	For wall mounting	64
7 Push-in fittings QS	For connecting compressed air tubing with standard O.D.	64
8 Silencer UC	For mounting in exhaust ports	64

# Solenoid valves MHE3, fast-switching valves

Technical data – Individual valve

Function

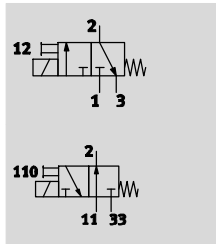

Voltage  
24 V DC



Pressure  
-0.9 ... +8 bar



Temperature range  
-5 ... +60 °C



General technical data	
Valve function	3/2 way, single solenoid <sup>1)</sup>
Design	Pressure-relieved poppet valve
Sealing principle	Soft
Reset method	Mechanical spring
Actuation type	Electric
Type of control	Direct
Direction of flow	Reversible with restrictions <sup>2)</sup>
Exhaust air function	With flow control
Manual override	Non-detenting
Mounting position	Any
Width	[mm] 14
Grid dimension	[mm] 19 (minimum distance 5 mm)
Nominal width	[mm] 3
Standard nominal flow rate	[l/min] 200
Type of mounting	Via through-holes
Pneumatic connection	Connecting thread G1/8 Push-in connector for tubing O.D. 6 mm
Product weight	[g] 120

- 1) Can be used as a 2/2-way valve by sealing port 3 or 33  
 2) Slight leakage can occur in the pressure range -0.8 bar to +0.5 bar.

Operating and environmental conditions		With fast-switching electronics	Without fast-switching electronics
Operating medium		Compressed air to ISO 8573-1:2010 [7:4:4]	
Note on operating/pilot medium		Lubricated operation possible (in which case lubricated operation will always be required)	
Operating pressure	[bar]	-0.9 ... +8	
	Reversible [bar]	-0.9 ... +1	
Ambient temperature	[°C]	-5 ... +60	
Temperature of medium	[°C]	-5 ... +60	
Restricted ambient and media temperature		As a function of switching frequency (see diagram)	
Corrosion resistance class CRC <sup>1)</sup>		2	
CE marking (see declaration of conformity)		To EU EMC Directive <sup>2)</sup>	-
Certification		c UL us Recognized (OL) RCM trademark	c UL us Recognized (OL) -

- 1) Corrosion resistance class 2 according to Festo standard 940 070  
 Components subject to moderate corrosion stress. Externally visible parts with primarily decorative surface requirements which are in direct contact with a normal industrial environment or media such as coolants or lubricating agents.  
 2) For information about the applicability of the component see the manufacturer's EC declaration of conformity at: [www.festo.com/sp](http://www.festo.com/sp) → Certificates.  
 If the component is subject to restrictions on usage in residential, office or commercial environments or small businesses, further measures to reduce the emitted interference may be necessary.

# Solenoid valves MHE3, fast-switching valves

Technical data – Individual valve

Electrical data		With fast-switching electronics	Without fast-switching electronics
Electrical connection		2-pin plug or moulded-in cable	
Operating voltage	[V DC]	24 ±10%	
Power consumption	[W]	6.5 for approx. 4.5 ms (high-current phase, pick-up current 1 A)	3.7
	[W]	1.6 (low-current phase)	–
Protection against incorrect polarity		Bipolar	–
Additional functions		Spark arresting	–
		Holding current reduction	–
		Protective circuit	–
Degree of protection to EN 60529	With moulded-in cable	IP65	IP65
	With connecting cable NEBV	IP65	IP65
	With plug socket with cable KMYZ-4	IP50	IP50
	With adapter VAVE-C8	IP65	IP65

Response times and switching frequencies				With fast-switching electronics	Without fast-switching electronics
Switching time	On	[ms]		2.3 +10% ... –30%	8.3
	Off	[ms]		2.8 +10% ... –50%	4.5
Switching time variation at 1 Hz and above		[ms]		0.2	–
Maximum switching frequency		[Hz]		280 <sup>1)</sup>	130

1) The ambient temperature must be limited with frequencies in excess of 90 Hz.

Safety data	
Resistance to shocks	Shock test with severity level 2 to FN 942017-5 and EN 60068-2-27
Vibration resistance	Transport application test with severity level 2 to FN 942017-4 and EN 60068-2-6

## Materials

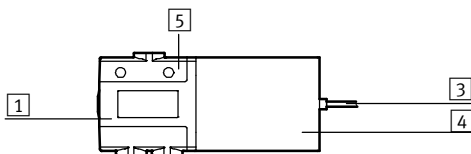

1	Housing	Die-cast zinc, coated
3	Cable sheath	Polyurethane
4	Coil housing	PA
5	Manifold rail	PA
–	Seals	HNBR, NBR
–	Screws	Galvanised steel
	Note on materials	Free of copper and PTFE RoHS-compliant

# Solenoid valves MHE3, fast-switching valves

Technical data – Individual valve

## Restricted ambient and media temperature as a function of switching frequency

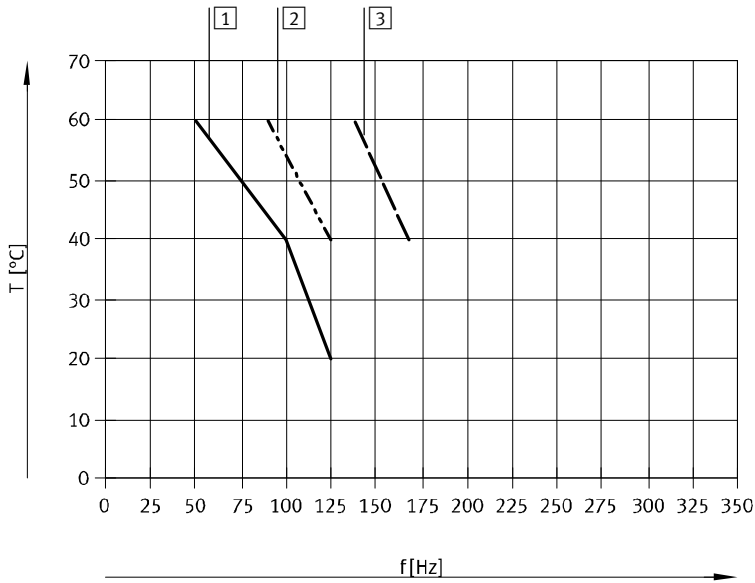

- 1 Manifold, 6 valves, pressureless
- 2 Manifold, 6 valves, flow through, 6 bar
- 3 Individual valve, pressureless

No restriction for individual valve, flow through, 6 bar.

## Current curve for valves with fast-switching electronics (MHE3-MS1H)

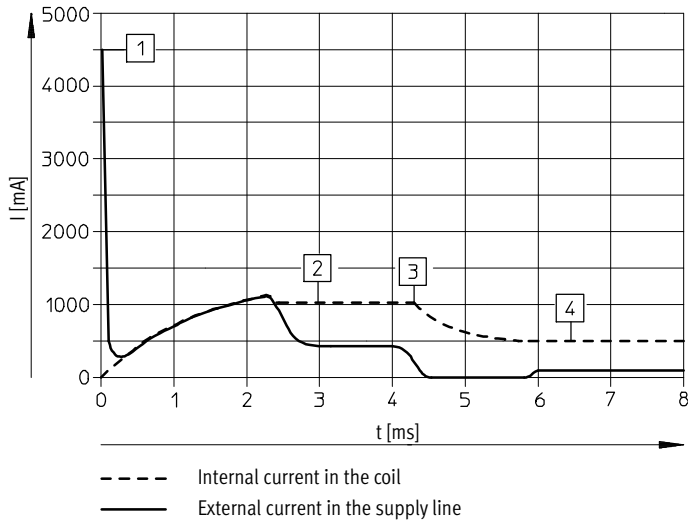

- 1 Capacitor charging
- 2 Controlled coil current 1 A
- 3 Reduction to holding current
- 4 Controlled holding current 0.5 A

# Solenoid valves MHE3, fast-switching valves

Technical data – Individual valve

FESTO

## Dimensions

Download CAD data → [www.festo.com](http://www.festo.com)

Valve with plug vanes or moulded-in cable

MHE3-...-1/8-...

MHE3-...-QS-6-...

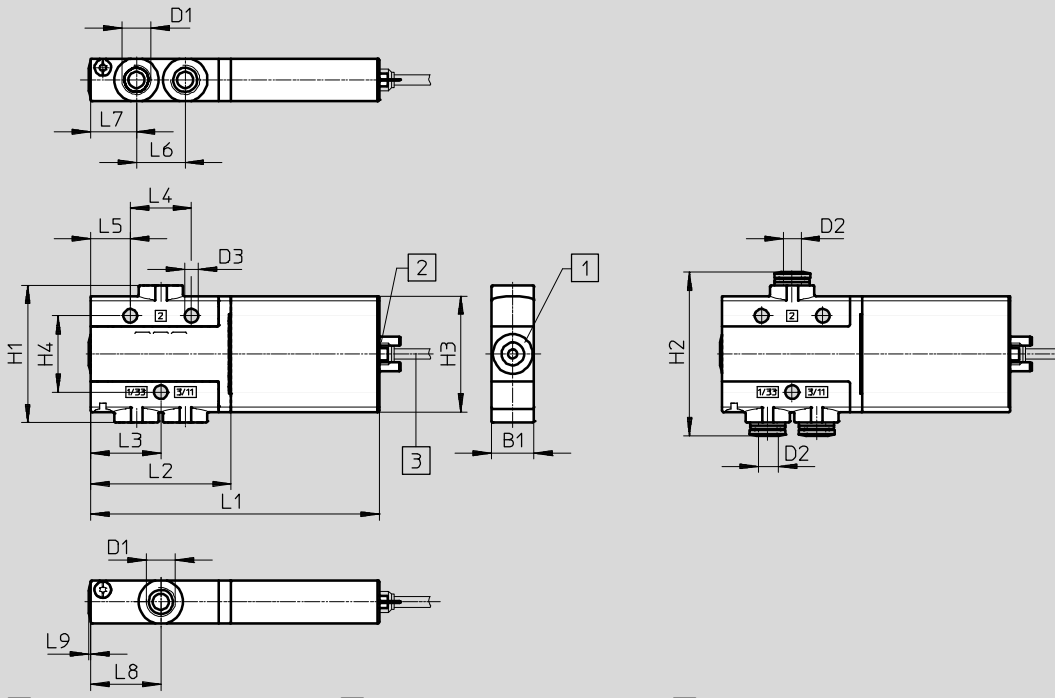

- 1 Manual override, non-detenting
- 2 Plug vanes
- 3 Cable 2.5 m

Type	B1	D1	D2 Ø	D3 Ø	H1	H2	H3	H4	L1	L2	L3	L4	L5	L6	L7	L8	L9
MHE3-...-1/8-...	14	G1/8	-	4.5	45	-	38	25	94.5	46	23	20	13	16	15	23	0.6
MHE3-...-QS-6-...	14	-	6	4.5	45	53.6	38	25	94.5	46	23	20	13	16	15	23	0.6

## Dimensions

Download CAD data → [www.festo.com](http://www.festo.com)

Mounting bracket MHE2-BG-L

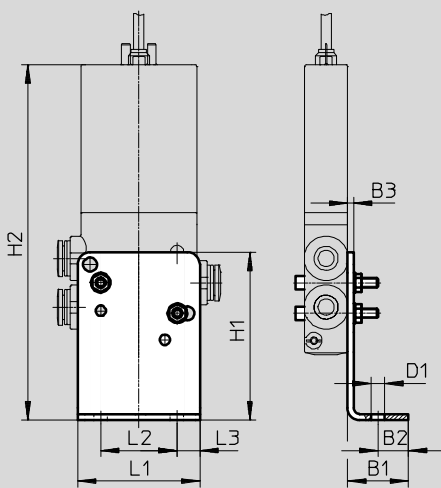

Type	B1	B2	B3	D1	H1	H2	L1	L2	L3
MHE2-BG-L	20	10	2	4.5	55	113.3	40	25	7.5



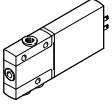
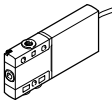

# Solenoid valves MHE3, fast-switching valves

Technical data – Individual valve

Ordering data					Part No.	Type
Valves						
	Electrical connection: plug vanes	With fast-switching electronics, switching time 2.3 ms	Pneumatic connection: thread G1/8	Normally open	<b>525167</b>	<b>MHE3-MS1H-3/20-1/8</b>
				Normally closed	<b>525147</b>	<b>MHE3-MS1H-3/2G-1/8</b>
			Pneumatic connection: push-in connector for tubing O.D. 6 mm	Normally open	<b>525171</b>	<b>MHE3-MS1H-3/20-QS-6</b>
				Normally closed	<b>525151</b>	<b>MHE3-MS1H-3/2G-QS-6</b>
		Without fast-switching electronics, switching time 8.3 ms	Pneumatic connection: thread G1/8	Normally open	<b>525166</b>	<b>MHE3-M1H-3/20-1/8</b>
				Normally closed	<b>525146</b>	<b>MHE3-M1H-3/2G-1/8</b>
			Pneumatic connection: push-in connector for tubing O.D. 6 mm	Normally open	<b>525170</b>	<b>MHE3-M1H-3/20-QS-6</b>
				Normally closed	<b>525150</b>	<b>MHE3-M1H-3/2G-QS-6</b>
	Electrical connection: cable	With fast-switching electronics, switching time 2.3 ms	Pneumatic connection: thread G1/8	Normally open	<b>525169</b>	<b>MHE3-MS1H-3/20-1/8-K</b>
				Normally closed	<b>525149</b>	<b>MHE3-MS1H-3/2G-1/8-K</b>
			Pneumatic connection: push-in connector for tubing O.D. 6 mm	Normally closed	<b>525153</b>	<b>MHE3-MS1H-3/2G-QS-6-K</b>
				Without fast-switching electronics, switching time 8.3 ms	Pneumatic connection: thread G1/8	Normally open
		Normally closed	<b>525148</b>			<b>MHE3-M1H-3/2G-1/8-K</b>
		Pneumatic connection: push-in connector for tubing O.D. 6 mm	Normally closed		<b>525152</b>	<b>MHE3-M1H-3/2G-QS-6-K</b>

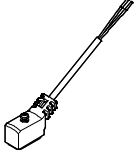
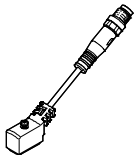
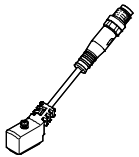
# Solenoid valves MHE3, fast-switching valves

Technical data – Individual valve

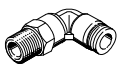
Ordering data					Part No.	Type	
Connecting cable (for valves with plug vanes)					Technical data → Internet: nebv		
	2-pin socket, open cable end 2-wire	PUR cable, degree of protection IP65	Signal status display with LED	Length: 2.5 m	<b>8047671</b>	<b>NEBV-Z4WA2L-P-E-2.5-N-LE2-S1</b>	
				Length: 5 m	<b>8047672</b>	<b>NEBV-Z4WA2L-P-E-5-N-LE2-S1</b>	
				Length: 10 m	<b>8047670</b>	<b>NEBV-Z4WA2L-P-E-10-N-LE2-S1</b>	
	2-pin socket, plug M8x1 3-pin	PVC cable, degree of protection IP50	Without signal status display	Length: 0.5 m	<b>193690</b>	<b>KMYZ-4-24-0,5-B</b>	
				Length: 2.5 m	<b>193691</b>	<b>KMYZ-4-24-2,5-B</b>	
	2-pin socket, plug M8x1 3-pin	PUR cable, degree of protection IP65	Signal status display with LED	Length: 0.5 m	<b>8047673</b>	<b>NEBV-Z4WA2L-P-E-0.5-N-M8G3-S1</b>	
				Length: 2.5 m	<b>8047674</b>	<b>NEBV-Z4WA2L-P-E-2.5-N-M8G3-S1</b>	
Adapter (for valves with plug vanes)							
	2-pin socket	Signal status display with LED	Plug M8, 3-pin	<b>571686</b>	<b>VAVE-C8-1R8</b>		
			Plug M8, 4-pin	<b>573194</b>	<b>VAVE-C8-1R1</b>		
Wall mounting							
	Mounting bracket			<b>196165</b>	<b>MHE2-BG-L</b>		
Silencer							
	Push-in sleeve with O.D. 6 mm		1 piece	<b>165007</b>	<b>UC-QS-6H</b>		
	With threaded connection G1/8		1 piece	<b>161419</b>	<b>UC-1/8</b>		
			50 pieces	<b>534219</b>	<b>UC-1/8-50</b>		
Push-in fitting							
	Male thread G1/8 with external hex for tubing O.D.	6 mm	10 pieces	<b>186096</b>	<b>QS-G1/8-6</b>		
			100 pieces	<b>132037</b>	<b>QS-G1/8-6-100</b>		
			8 mm	10 pieces	<b>186098</b>	<b>QS-G1/8-8</b>	
			50 pieces	<b>132038</b>	<b>QS-G1/8-8-50</b>		
	Male thread G1/8 with external hex, push-in L-fitting rotatable through 360° for tubing O.D.	6 mm	10 pieces	<b>186117</b>	<b>QSL-G1/8-6</b>		
			100 pieces	<b>132049</b>	<b>QSL-G1/8-6-100</b>		
		8 mm	10 pieces	<b>186119</b>	<b>QSL-G1/8-8</b>		
			50 pieces	<b>132050</b>	<b>QSL-G1/8-8-50</b>		



# Solenoid valves MHP3, fast-switching valves

Peripherals overview – Semi in-line valve

Connection with plug vanes – Connection with moulded-in cable

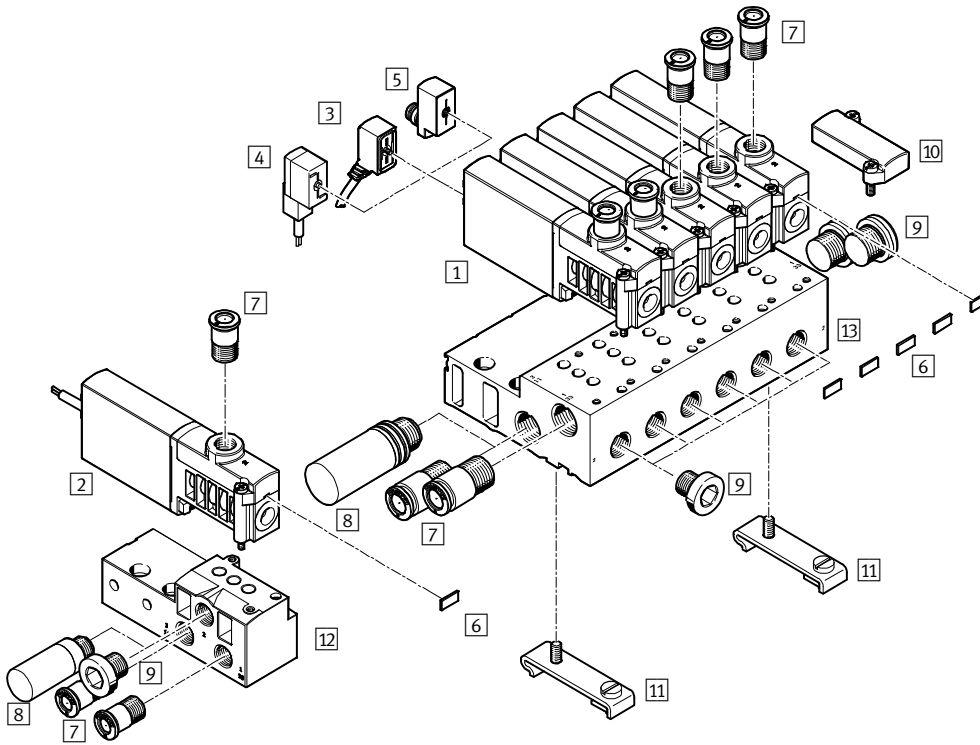

Designation	Brief description	→ Page/Internet
1 Semi in-line valve MHP3	With plug vanes	72
2 Semi in-line valve MHP3-...-K	With cable	72
3 Connecting cable NEBV	PUR cable, switching signal display with LED, IP65	72
4 Plug socket with cable KMYZ-4	PVC cable, without signal status display, IP50	72
5 Adapter VAVE-C8	For connecting the valves via connecting cable M8 3-pin or 4-pin, IP65	72
6 Inscription label MH-BZ-80X	For identifying the valves	73
7 Push-in fittings QS	For connecting compressed air tubing with standard O.D.	73
8 Silencer UC	For mounting in exhaust ports	73
9 Blanking plug B	For sealing unused ports	73
10 Cover plate MHAP3-BP-3	For sealing vacant positions	72
11 H-rail mounting CPV10/14-VI-BG-NRH-35	For mounting the manifold block on H-rails according to EN 60715	73
12 Individual sub-base MHA3-AS-3-1/8	For semi in-line valves; the individual sub-base is also used for sub-base valves and must be sealed with a blanking plug here	72
13 Manifold block MHA3-PR	For semi in-line valves	72



# Solenoid valves MHP3, fast-switching valves

Technical data – Semi in-line valve

FESTO

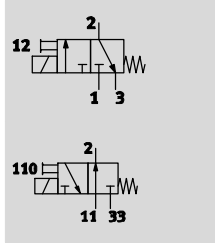
Function



-  - Voltage  
24 V DC
-  - Pressure  
-0.9 ... +8 bar
-  - Temperature range  
-5 ... +40 °C



General technical data		
Valve function		3/2 way, single solenoid <sup>1)</sup>
Design		Pressure-relieved poppet valve
Sealing principle		Soft
Reset method		Mechanical spring
Actuation type		Electric
Type of control		Direct
Direction of flow		Reversible with restrictions <sup>2)</sup>
Exhaust air function		With flow control
Manual override		Non-detenting
Mounting position		Any
Width	[mm]	14
Grid dimension	[mm]	19
Nominal width	[mm]	3
Standard nominal flow rate	[l/min]	200
Type of mounting		On PR rail
Pneumatic connection	2 1, 11, 3, 33, 5	Connecting thread G1/8, push-in connector for tubing O.D. 6 mm Sub-base
Product weight	[g]	120

- 1) Can be used as a 2/2-way valve by sealing port 3 or 33
- 2) Slight leakage can occur in the pressure range -0.8 bar to +0.5 bar.

Operating and environmental conditions			
		With fast-switching electronics	Without fast-switching electronics
Operating medium		Compressed air to ISO 8573-1:2010 [7:4:4]	
Note on operating/pilot medium		Lubricated operation possible (in which case lubricated operation will always be required)	
Operating pressure	[bar]	-0.9 ... +8	
	Reversible [bar]	-0.9 ... +1	
Ambient temperature	[°C]	-5 ... +40	
Temperature of medium	[°C]	-5 ... +40	
Restricted ambient and media temperature		As a function of switching frequency (see diagram)	
Corrosion resistance class CRC <sup>1)</sup>		2	
CE marking (see declaration of conformity)		To EU EMC Directive <sup>2)</sup>	-
Certification		c UL us Recognized (OL) RCM trademark	c UL us Recognized (OL) -

- 1) Corrosion resistance class 2 according to Festo standard 940 070  
Components subject to moderate corrosion stress. Externally visible parts with primarily decorative surface requirements which are in direct contact with a normal industrial environment or media such as coolants or lubricating agents.
- 2) For information about the applicability of the component see the manufacturer's EC declaration of conformity at: [www.festo.com/sp](http://www.festo.com/sp) → Certificates.  
If the component is subject to restrictions on usage in residential, office or commercial environments or small businesses, further measures to reduce the emitted interference may be necessary.

# Solenoid valves MHP3, fast-switching valves

Technical data – Semi in-line valve

Electrical data		With fast-switching electronics	Without fast-switching electronics
Electrical connection		2-pin plug or moulded-in cable	
Operating voltage	[V DC]	24 ±10%	
Power consumption	[W]	6.5 for approx. 4.5 ms (high-current phase, pick-up current 1 A)	3.7
	[W]	1.6 (low-current phase)	–
Protection against incorrect polarity		Bipolar	–
Additional functions		Spark arresting	–
		Holding current reduction	–
		Protective circuit	–
Degree of protection to EN 60529	With moulded-in cable	IP65	IP65
	With connecting cable NEBV	IP65	IP65
	With plug socket with cable KMYZ-4	IP50	IP50
	With adapter VAVE-C8	IP65	IP65

Response times and switching frequencies				With fast-switching electronics	Without fast-switching electronics
Switching time	On	[ms]		2.3 +10% ... –30%	8.3
	Off	[ms]		2.8 +10% ... –50%	4.5
Switching time variation at 1 Hz and above		[ms]		0.2	–
Maximum switching frequency		[Hz]		280 <sup>1)</sup>	130

1) The ambient temperature must be limited with frequencies in excess of 100 Hz.

Safety data	
Resistance to shocks	Shock test with severity level 2 to FN 942017-5 and EN 60068-2-27
Vibration resistance	Transport application test with severity level 2 to FN 942017-4 and EN 60068-2-6

## Materials

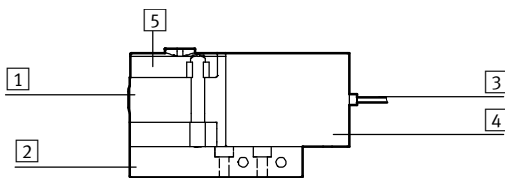

1	Housing	Die-cast zinc, coated
2	Sub-base	Aluminium in the case of the manifold, die-cast zinc in the case of individual sub-base
3	Cable sheath	PUR
4	Coil housing	PA
5	Manifold rail	PA
–	Seals	HNBR, NBR
–	Screws	Galvanised steel
Note on materials		Free of copper and PTFE RoHS-compliant

# Solenoid valves MHP3, fast-switching valves

Technical data – Semi in-line valve

## Restricted ambient and media temperature as a function of switching frequency

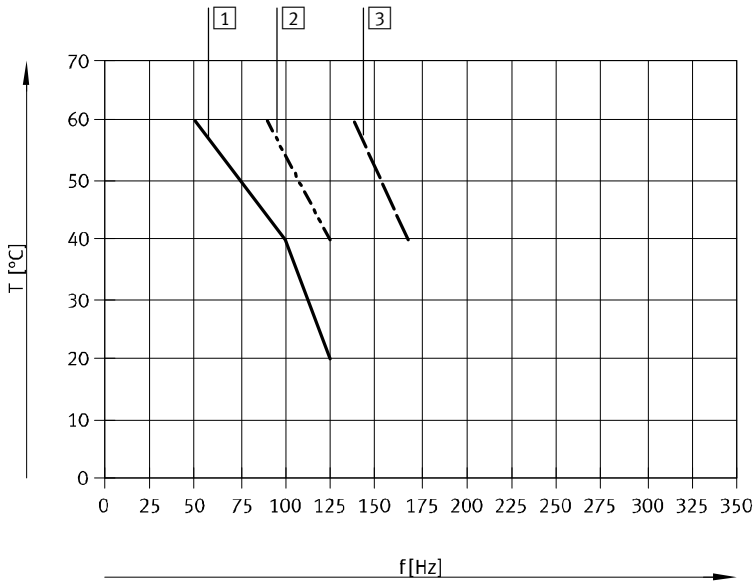

- 1 Manifold, 6 valves, pressureless
- 2 Manifold, 6 valves, flow through, 6 bar
- 3 Individual valve, pressureless

No restriction for individual valve, flow through, 6 bar.

## Current curve for valves with fast-switching electronics (MHP3-MS1H)

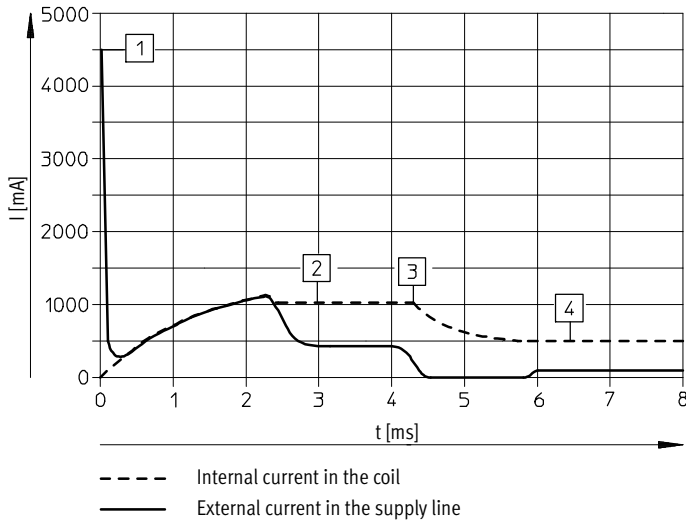

- 1 Capacitor charging
- 2 Controlled coil current 1 A
- 3 Reduction to holding current
- 4 Controlled holding current 0.5 A

# Solenoid valves MHP3, fast-switching valves

Technical data – Semi in-line valve

**Dimensions**

Download CAD data → [www.festo.com](http://www.festo.com)

Valve with connecting thread G1/8

Valve with push-in connector for tubing O.D. 6 mm

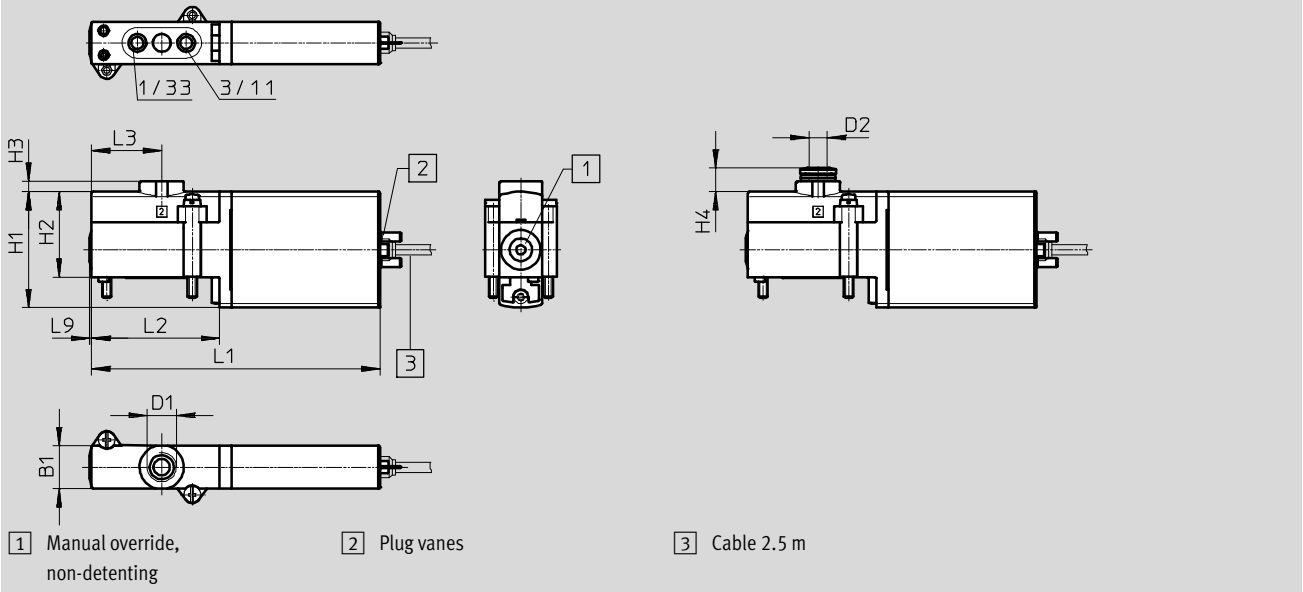

Type	B1	D1	D2 ∅	H1	H2	H3	H4	L1	L2	L3	L9
MHP3-...-3/2...	14	G1/8	6	38	28	3.5	7.8	94.5	42	23	0.6

# Solenoid valves MHP3, fast-switching valves

Technical data – Semi in-line valve



## Dimensions

Download CAD data → [www.festo.com](http://www.festo.com)

Hole pattern on sub-bases

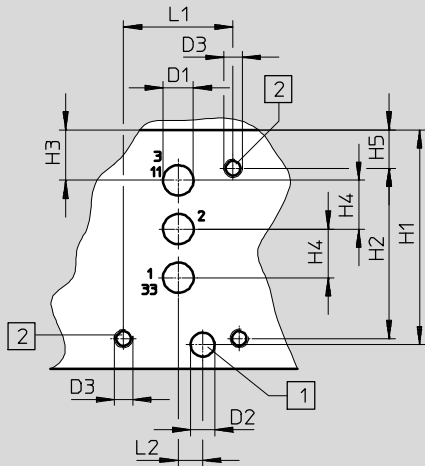

- 1 Drill hole for coding pin, 2 mm deep
- 2 Mounting thread, 8 mm deep



Note

With semi in-line valves, port 2 is not used.

If used as a 2/2-way valve, normally closed, ports 3/11 are not used.

If used as a 2/2-way valve, normally open, ports 1/33 are not used.

Individual sub-base, MHA3-AS-3-1/8

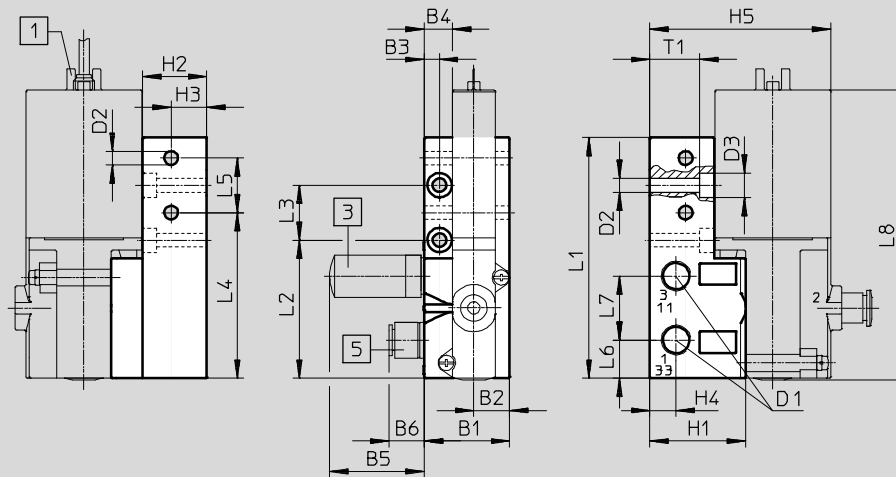

- 1 Plug vanes
- 3 Silencer
- 5 Push-in fitting

Type	B1	B2	B3	B4	B5	B6	D1	D2	D3	H1	H2	H3	H4	H5
Hole pattern	-	-	-	-	-	-	5	4	M3	35.3	28	8.3	8	6.3
MHA3-AS-3-1/8	28	11.8	5	9.3	31.5	13.3	G1/8	4.5	8	31.3	21	11.7	8.6	59.3

Type	L1	L2	L3	L4	L5	L6	L7	L8	T1
Hole pattern	18	4	-	-	-	-	-	-	-
MHA3-AS-3-1/8	78.9	45.3	18	54.3	17.9	12.5	21	95	16.4

# Solenoid valves MHP3, fast-switching valves

Technical data – Semi in-line valve

## Dimensions

Download CAD data → [www.festo.com](http://www.festo.com)

Manifold assembly, MHA3-PR...-1/8

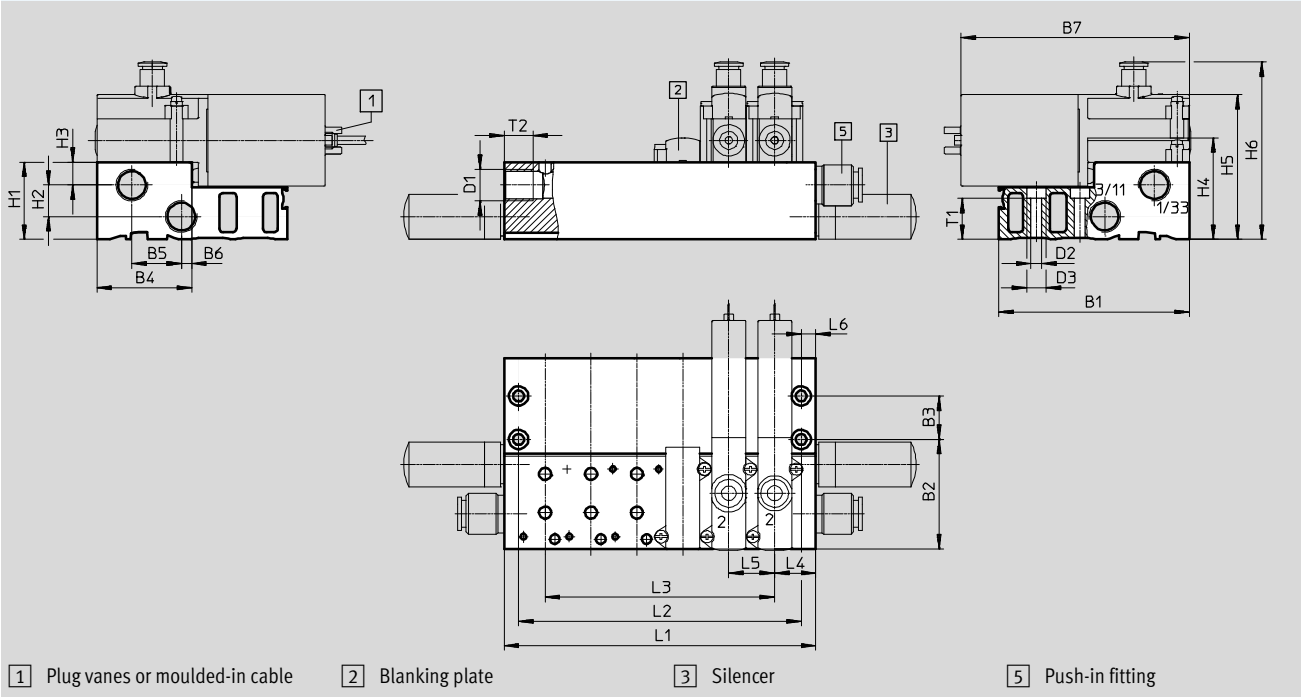

H-rail mounting CPV10/14-VI-BG-NRH-35

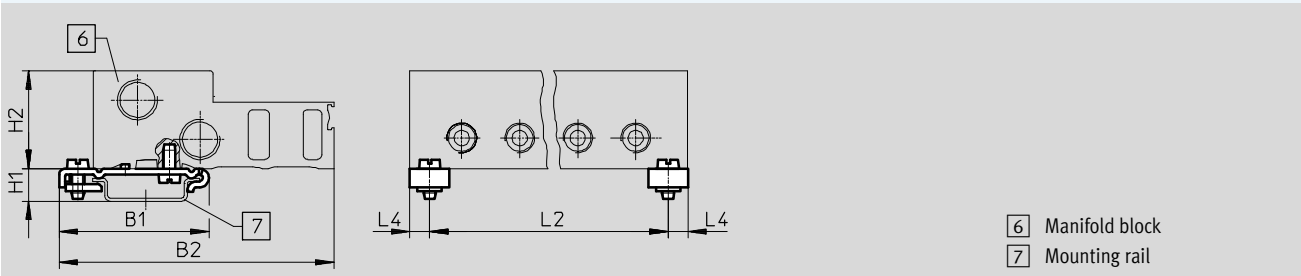

Type	B1	B2	B3	B4	B5	B6	B7	D1	D2 Ø	D3 Ø	H1	H2	H3	H4	H5	H6	L4	L5	L6	T1	T2
MHA3-PR...-1/8	79	45.3	18	39.3	20.5	4.3	94.5	G1/4	4.5	8	32	13	9.5	42	60	73.5	17	19	6	17.1	12
CPV10/14-VI-BG...	49.1	90	-	-	-	-	-	-	-	-	10.7	32	-	-	-	-	6.5	-	-	-	-







Type		Number of valve positions				
		2	4	6	8	10
MHA3-PR...-1/8	L1	53	91	129	167	205
	L2	41	79	117	155	193
	L3	19	57	95	133	171
CPV10/14-VI-BG...	L2	40	78	116	154	192

Note  
Valve types 3/2G and 3/2O must not be mixed on a manifold block.

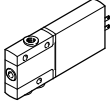
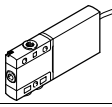
# Solenoid valves MHP3, fast-switching valves

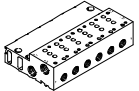
FESTO

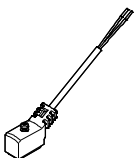
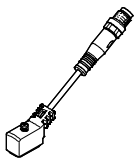
Technical data – Semi in-line valve





Ordering data					Part No.	Type
<b>Valves</b>						
	Electrical connection: plug vanes	With fast-switching electronics, switching time 2.3 ms	Pneumatic connection: thread G1/8	Normally open	<b>525159</b>	<b>MHP3-MS1H-3/20-1/8</b>
				Normally closed	<b>525139</b>	<b>MHP3-MS1H-3/2G-1/8</b>
			Pneumatic connection: push-in connector for tubing O.D. 6 mm	Normally closed	<b>525143</b>	<b>MHP3-MS1H-3/2G-QS-6</b>
		Without fast-switching electronics, switching time 8.3 ms	Pneumatic connection: thread G1/8	Normally open	<b>525158</b>	<b>MHP3-M1H-3/20-1/8</b>
				Normally closed	<b>525138</b>	<b>MHP3-M1H-3/2G-1/8</b>
			Pneumatic connection: push-in connector for tubing O.D. 6 mm	Normally closed	<b>525142</b>	<b>MHP3-M1H-3/2G-QS-6</b>
	Electrical connection: cable	With fast-switching electronics, switching time 2.3 ms	Pneumatic connection: push-in connector for tubing O.D. 6 mm	Normally closed	<b>525145</b>	<b>MHP3-MS1H-3/2G-QS-6-K</b>
<b>Manifold rail</b>						
	Individual sub-base <sup>1)</sup> Pneumatic connection: thread G1/8		1 valve position	<b>525214</b>	<b>MHA3-AS-3-1/8</b>	
	Manifold block <sup>1)</sup> Pneumatic connection 1, 11, 3, 33: thread G1/4 Pneumatic connection 2: thread G1/8		2 valve positions	<b>525221</b>	<b>MHA3-PR2-3-1/8</b>	
			4 valve positions	<b>525222</b>	<b>MHA3-PR4-3-1/8</b>	
			6 valve positions	<b>525223</b>	<b>MHA3-PR6-3-1/8</b>	
			8 valve positions	<b>525224</b>	<b>MHA3-PR8-3-1/8</b>	
			10 valve positions	<b>525225</b>	<b>MHA3-PR10-3-1/8</b>	
<b>Cover plate</b>						
	Vacant valve positions must be sealed with a cover plate				<b>525226</b>	<b>MHAP3-BP-3</b>
<b>Connecting cable (for valves with plug vanes)</b>					Technical data → Internet: nebv	
	2-pin socket, open cable end 2-wire	PUR cable, degree of protection IP65	Signal status display with LED	2.5 m long	<b>8047671</b>	<b>NEBV-Z4WA2L-P-E-2.5-N-LE2-S1</b>
				5 m long	<b>8047672</b>	<b>NEBV-Z4WA2L-P-E-5-N-LE2-S1</b>
		PVC cable, degree of protection IP50	Without signal status display	0.5 m long	<b>193690</b>	<b>KMYZ-4-24-0,5-B</b>
				2.5 m long	<b>193691</b>	<b>KMYZ-4-24-2,5-B</b>
	2-pin socket, plug M8x1 3-pin	PUR cable, degree of protection IP65	Signal status display with LED	0.5 m long	<b>8047673</b>	<b>NEBV-Z4WA2L-P-E-0.5-N-M8G3-S1</b>
				2.5 m long	<b>8047674</b>	<b>NEBV-Z4WA2L-P-E-2.5-N-M8G3-S1</b>
<b>Adapter (for valves with plug vanes)</b>						
	2-pin socket	Signal status display with LED	Plug M8, 3-pin	<b>571686</b>	<b>VAVE-C8-1R8</b>	
			Plug M8, 4-pin	<b>573194</b>	<b>VAVE-C8-1R1</b>	

1) Seal port 2 with a blanking plug. These ports have no function when using semi in-line valves.

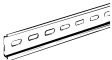

# Solenoid valves MHP3, fast-switching valves

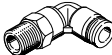
Technical data – Semi in-line valve

Ordering data					
				Part No.	Type
<b>H-rail mounting</b>					
	For manifold block			<b>162556</b>	<b>CPV10/14-VI-BG-NRH-35</b>
<b>H-rail</b>					
	To EN 60715	2 m		<b>35430</b>	<b>NRH-35-2000</b>
<b>Silencer</b> <span style="float: right;">Technical data → Internet: uc</span>					
	Push-in sleeve with O.D. 6 mm		1 piece	<b>165007</b>	<b>UC-QS-6H</b>
	With threaded connection	G1/8	1 piece	<b>161419</b>	<b>UC-1/8</b>
			50 pieces	<b>534219</b>	<b>UC-1/8-50</b>
		G1/4	1 piece	<b>165004</b>	<b>UC-1/4</b>
	20 pieces		<b>534220</b>	<b>UC-1/4-20</b>	
<b>Push-in fitting</b> <span style="float: right;">Technical data → Internet: qs</span>					
	Male thread G1/8 with external hex for tubing O.D.	6 mm	10 pieces	<b>186096</b>	<b>QS-G1/8-6</b>
			100 pieces	<b>132037</b>	<b>QS-G1/8-6-100</b>
		8 mm	10 pieces	<b>186098</b>	<b>QS-G1/8-8</b>
	50 pieces		<b>132038</b>	<b>QS-G1/8-8-50</b>	
	Male thread G1/4 with external hex for tubing O.D.		8 mm	10 pieces	<b>186099</b>
		50 pieces		<b>132040</b>	<b>QS-G1/4-8-50</b>
10 mm		10 pieces	<b>186101</b>	<b>QS-G1/4-10</b>	
	Male thread G1/8 with external hex, push-in L-fitting rotatable through 360° for tubing O.D.	6 mm	10 pieces	<b>186117</b>	<b>QSL-G1/8-6</b>
			100 pieces	<b>132049</b>	<b>QSL-G1/8-6-100</b>
		8 mm	10 pieces	<b>186119</b>	<b>QSL-G1/8-8</b>
	50 pieces		<b>132050</b>	<b>QSL-G1/8-8-50</b>	
	Male thread G1/4 with external hex, push-in L-fitting rotatable through 360° for tubing O.D.		8 mm	10 pieces	<b>186120</b>
		50 pieces		<b>132052</b>	<b>QSL-G1/4-8-50</b>
10 mm		10 pieces	<b>186122</b>	<b>QSL-G1/4-10</b>	
50 pieces	<b>132053</b>	<b>QSL-G1/4-10-50</b>			
<b>Blanking plug</b>					
	For thread G1/8		10 pieces	<b>3568</b>	<b>B-1/8</b>
	For thread G1/4		10 pieces	<b>3569</b>	<b>B-1/4</b>
<b>Inscription label</b>					
	For solenoid valve		80 pieces in frame	<b>197259</b>	<b>MH-BZ-80X</b>

# Solenoid valves MHA3, fast-switching valves

Peripherals overview – Sub-base valve

## Connection with plug vanes – Connection with moulded-in cable

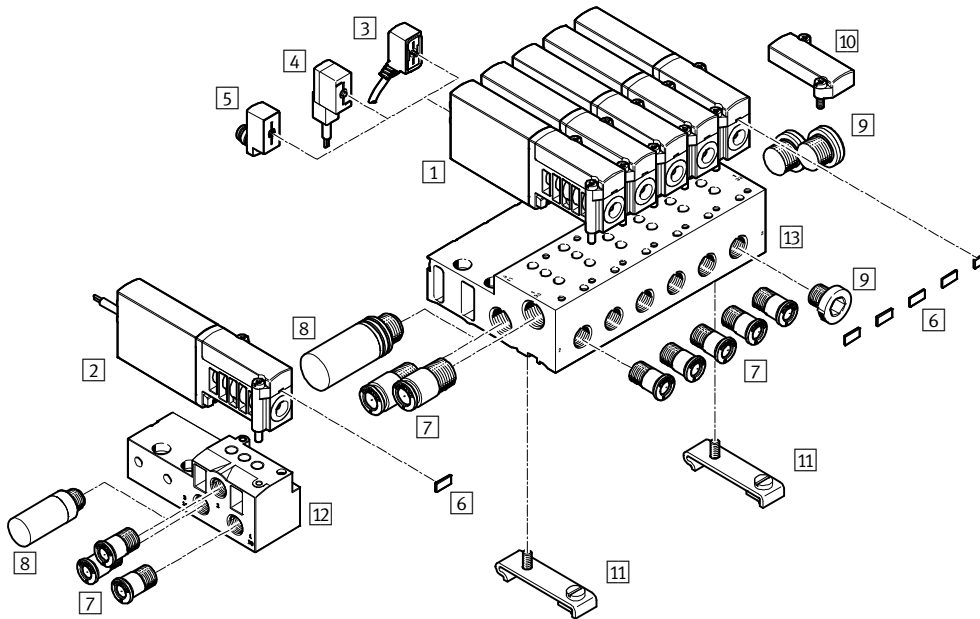

Designation	Brief description	→ Page/Internet
1 Sub-base valve MHA3	With plug vanes	80
2 Sub-base valve MHA3-...-K	With cable	80
3 Connecting cable NEBV	PUR cable, signal status display with LED, IP65	80
4 Plug socket with cable KMYZ-4	PVC cable, without signal status display, IP50	80
5 Adapter VAVE-C8	For connecting the valves via connecting cable M8 3-pin or 4-pin, IP65	80
6 Inscription label MH-BZ-80X	For identifying the valves	81
7 Push-in fittings QS	For connecting compressed air tubing with standard O.D.	81
8 Silencer UC	For mounting in exhaust ports	81
9 Blanking plug B	For sealing unused ports	81
10 Cover plate MHAP3-BP-3	For sealing vacant positions	80
11 H-rail mounting CPV10/14-VI-BG-NRH-35	For mounting the manifold block on H-rails according to EN 60715	81
12 Individual sub-base MHA3-AS-3-1/8	For sub-base valve	80
13 Manifold block MHA3-PR...-3-1/8	For sub-base valve	80

# Solenoid valves MHA3, fast-switching valves

Technical data – Sub-base valve

Function

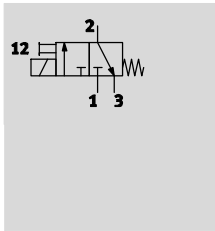

- - Voltage  
24 V DC
- - Pressure  
-0.9 ... +8 bar
- - Temperature range  
-5 ... +40 °C

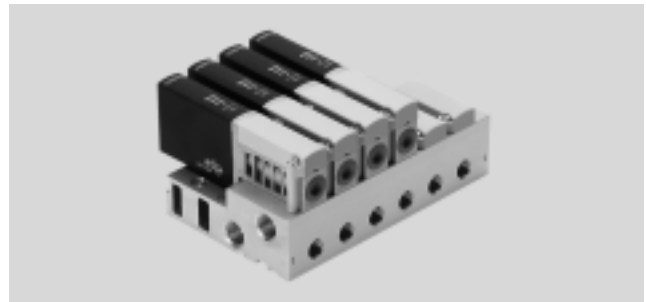

General technical data		
Valve function		3/2 way, single solenoid <sup>1)</sup>
Design		Pressure-relieved poppet valve
Sealing principle		Soft
Reset method		Mechanical spring
Actuation type		Electric
Type of control		Direct
Direction of flow		Reversible with restrictions <sup>2)</sup>
Exhaust air function		With flow control
Manual override		Non-detenting
Mounting position		Any
Width	[mm]	14
Grid dimension	[mm]	19
Nominal width	[mm]	3
Standard nominal flow rate	[l/min]	200
Type of mounting		On PR rail, via through-hole
Pneumatic connection		Sub-base
Product weight	[g]	120

- 1) Can be used as a 2/2-way valve by sealing port 3 or 33
- 2) Slight leakage can occur in the pressure range -0.8 bar to +0.5 bar.

Operating and environmental conditions			
		With fast-switching electronics	Without fast-switching electronics
Operating medium		Compressed air to ISO 8573-1:2010 [7:4:4]	
Note on operating/pilot medium		Lubricated operation possible (in which case lubricated operation will always be required)	
Operating pressure		-0.9 ... +8	
	Reversible	-0.9 ... +1	
Ambient temperature	[°C]	-5 ... +40	
Temperature of medium	[°C]	-5 ... +40	
Restricted ambient and media temperature		As a function of switching frequency (see diagram)	
Corrosion resistance class CRC <sup>1)</sup>		2	
CE marking (see declaration of conformity)		To EU EMC Directive <sup>2)</sup>	-
Certification		c UL us Recognized (OL)	c UL us Recognized (OL)
		RCM trademark	-

- 1) Corrosion resistance class 2 according to Festo standard 940 070  
Components subject to moderate corrosion stress. Externally visible parts with primarily decorative surface requirements which are in direct contact with a normal industrial environment or media such as coolants or lubricating agents.
- 2) For information about the applicability of the component see the manufacturer's EC declaration of conformity at: [www.festo.com/sp](http://www.festo.com/sp) → Certificates.  
If the component is subject to restrictions on usage in residential, office or commercial environments or small businesses, further measures to reduce the emitted interference may be necessary.

# Solenoid valves MHA3, fast-switching valves

Technical data – Sub-base valve

Electrical data		With fast-switching electronics	Without fast-switching electronics
Electrical connection		2-pin plug or moulded-in cable	
Operating voltage	[V DC]	24 ±10%	
Power consumption	[W]	6.5 for approx. 4.5 ms (high-current phase, pick-up current 1 A)	3.7
	[W]	1.6 (low-current phase)	–
Protection against incorrect polarity		Bipolar	–
Additional functions		Spark arresting	–
		Holding current reduction	–
		Protective circuit	–
Degree of protection to EN 60529	With moulded-in cable	IP65	IP65
	With connecting cable NEBV	IP65	IP65
	With plug socket with cable KMYZ-4	IP50	IP50
	With adapter VAVE-C8	IP65	IP65

Response times and switching frequencies				With fast-switching electronics	Without fast-switching electronics
Switching time	On	[ms]		2.3 +10% ... –30%	8.3
	Off	[ms]		2.8 +10% ... –30%	4.5
Switching time variation at 1 Hz and above		[ms]		0.2	–
Maximum switching frequency		[Hz]		280 <sup>1)</sup>	130

1) The ambient temperature must be limited with frequencies in excess of 100 Hz.

Safety data	
Resistance to shocks	Shock test with severity level 2 to FN 942017-5 and EN 60068-2-27
Vibration resistance	Transport application test with severity level 2 to FN 942017-4 and EN 60068-2-6

## Materials

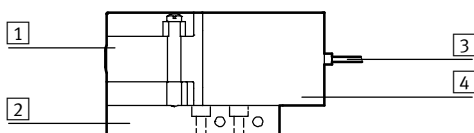

1	Housing	Die-cast zinc, coated
2	Sub-base	Aluminium in the case of the manifold, die-cast zinc in the case of the individual sub-base
3	Cable sheath	PUR
4	Coil housing	PA
–	Seals	HNBR, NBR
–	Screws	Galvanised steel
	Note on materials	Free of copper and PTFE RoHS-compliant

# Solenoid valves MHA3, fast-switching valves

Technical data – Sub-base valve

## Restricted ambient and media temperature as a function of switching frequency

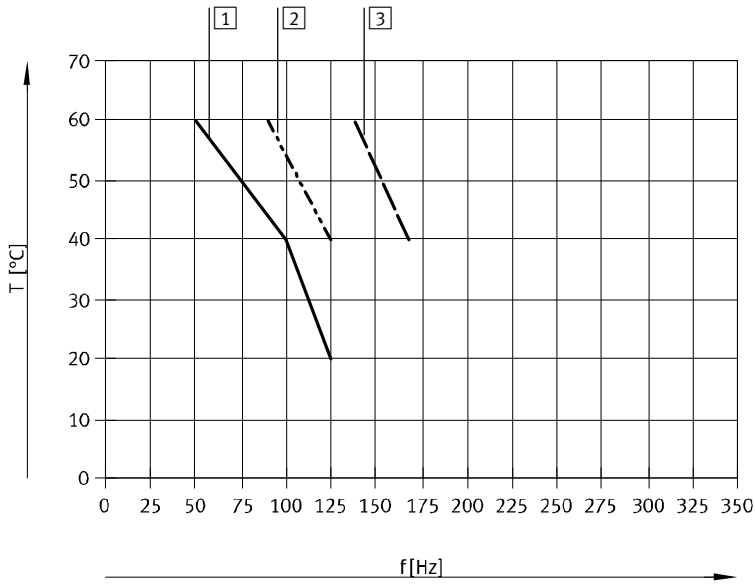

- 1 Manifold, 6 valves, pressureless
- 2 Manifold, 6 valves, flow through, 6 bar
- 3 Individual valve, pressureless

No restriction for individual valve, flow through, 6 bar.

## Current curve for valves with fast-switching electronics (MHA3-MS1H)

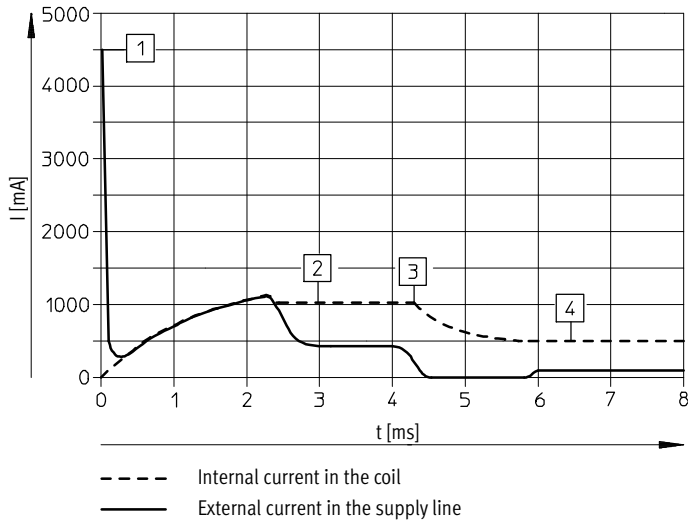

- 1 Capacitor charging
- 2 Controlled coil current 1 A
- 3 Reduction to holding current
- 4 Controlled holding current 0.5 A

# Solenoid valves MHA3, fast-switching valves

Technical data – Sub-base valve

**Dimensions** Download CAD data → [www.festo.com](http://www.festo.com)

Valve with plug vanes or moulded-in cable, MHA3-...-3/2G...

1 Manual override, non-detenting  
2 Plug vanes  
3 Cable 2.5 m

Hole pattern on sub-bases

1 Drill hole for coding pin, 2 mm  
2 Mounting thread, 8 mm deep

Type	B1	D1	D2 ∅	D3 ∅	H1	H2	H3	H4	H5	L1	L2	L9
MHA3-...-3/2G...	14	-	-	-	38	28	-	-	-	94.5	42	0.6
Hole pattern	-	5	4	M3	35.3	28	8.3	8	6.3	18	4	-

**Dimensions** Download CAD data → [www.festo.com](http://www.festo.com)

Individual sub-base, MHA3-AS-3-1/8

1 Plug vanes  
3 Silencer  
5 Push-in fitting

Type	B1	B2	B3	B4	B5	B6	D1	D2 ∅	D3 ∅	H1	H2	H3	H4	H5	H6
MHA3-AS-3-1/8	28	11.8	5	9.3	31.5	13.3	G1/8	4.5	8	31.3	21	11.7	8.6	23.2	59.3

Type	L1	L2	L3	L4	L5	L6	L7	L8	L9	T1
MHA3-AS-3-1/8	78.9	45.3	18	54.3	17.9	12.5	21	23	95	16.4

# Solenoid valves MHA3, fast-switching valves

Technical data – Sub-base valve

## Dimensions

Download CAD data → [www.festo.com](http://www.festo.com)

Manifold assembly, MHA3-PR...-1/8

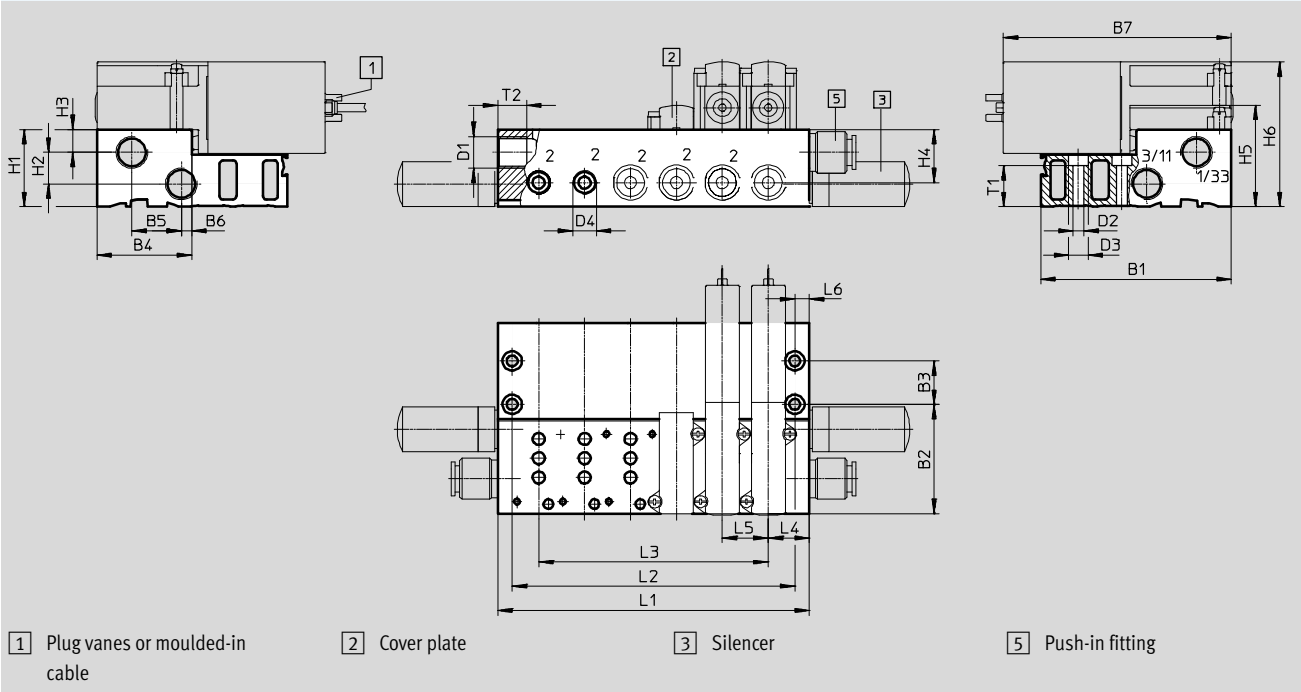

## H-rail mounting CPV10/14-VI-BG-NRH-35

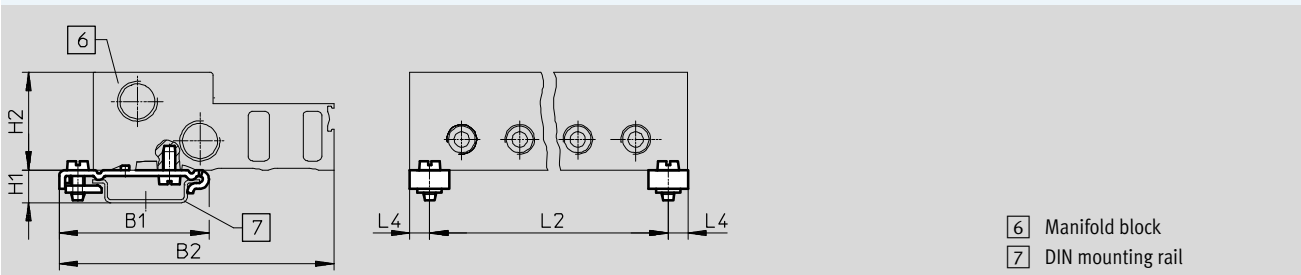







Type	B1	B2	B3	B4	B5	B6	B7	D1	D2	D3	D4	H1	H2	H3	H4	H5	H6
MHA3-PR...-1/8	79	45.3	18	39.3	20.5	4.3	94.3	G1/4	4.5	8	G1/8	32	13	9.5	22	42	60
CPV10/14-VI-BG-...	49.1	90	-	-	-	-	-	-	-	-	-	10.7	32	-	-	-	-

Type	L4	L5	L6	T1	T2
MHA3-PR...-1/8	17	19	6	17.1	12
CPV10/14-VI-BG-...	6.5	-	-	-	-

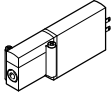
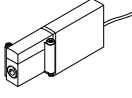
Type		Number of valve positions				
		2	4	6	8	10
MHA3-PR...-1/8	L1	53	91	129	167	205
	L2	41	79	117	155	193
	L3	19	57	95	133	171
CPV10/14-VI-BG-...	L2	41	79	117	155	193

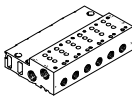
# Solenoid valves MHA3, fast-switching valves

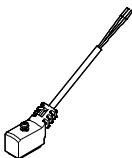
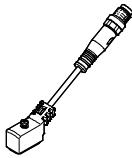
Technical data – Sub-base valve





Ordering data					Part No.	Type
<b>Valves</b>						
	Electrical connection: plug vanes	With fast-switching electronics, switching time 2.3 ms	Normally closed	<b>525135</b>	<b>MHA3-MS1H-3/2G-3</b>	
		Without fast-switching electronics, switching time 8.3 ms	Normally closed	<b>525134</b>	<b>MHA3-M1H-3/2G-3</b>	
	Electrical connection: cable	With fast-switching electronics, switching time 2.3 ms	Normally closed	<b>525137</b>	<b>MHA3-MS1H-3/2G-3-K</b>	
		Without fast-switching electronics, switching time 8.3 ms	Normally closed	<b>525136</b>	<b>MHA3-M1H-3/2G-3-K</b>	
<b>Manifold rail</b>						
	Individual sub-base Pneumatic connection: thread G1/8		1 valve position	<b>525214</b>	<b>MHA3-AS-3-1/8</b>	
	Manifold block Pneumatic connection 1, 11, 3, 33: thread G1/4 Pneumatic connection 2: thread G1/8		2 valve positions	<b>525221</b>	<b>MHA3-PR2-3-1/8</b>	
			4 valve positions	<b>525222</b>	<b>MHA3-PR4-3-1/8</b>	
			6 valve positions	<b>525223</b>	<b>MHA3-PR6-3-1/8</b>	
			8 valve positions	<b>525224</b>	<b>MHA3-PR8-3-1/8</b>	
			10 valve positions	<b>525225</b>	<b>MHA3-PR10-3-1/8</b>	
<b>Cover plate</b>						
	Vacant valve positions must be sealed with a cover plate			<b>525226</b>	<b>MHAP3-BP-3</b>	
<b>Connecting cable</b> <span style="float: right;">Technical data → Internet: nebv</span>						
	2-pin socket, open cable end 2-wire	PUR cable, degree of protection IP65	Signal status display with LED	2.5 m long	<b>8047671</b>	<b>NEBV-Z4WA2L-P-E-2.5-N-LE2-S1</b>
				5 m long	<b>8047672</b>	<b>NEBV-Z4WA2L-P-E-5-N-LE2-S1</b>
				10 m long	<b>8047670</b>	<b>NEBV-Z4WA2L-P-E-10-N-LE2-S1</b>
		PVC cable, degree of protection IP50	Without signal status display	0.5 m long	<b>193690</b>	<b>KMYZ-4-24-0,5-B</b>
2.5 m long	<b>193691</b>			<b>KMYZ-4-24-2,5-B</b>		
	2-pin socket, push-in connector M8x1 3-pin	PUR cable, degree of protection IP65	Signal status display with LED	0.5 m long	<b>8047673</b>	<b>NEBV-Z4WA2L-P-E-0.5-N-M8G3-S1</b>
				2.5 m long	<b>8047674</b>	<b>NEBV-Z4WA2L-P-E-2.5-N-M8G3-S1</b>
<b>Adapter (for valves with plug vanes)</b>						
	2-pin socket	Signal status display with LED	Plug M8, 3-pin	<b>571686</b>	<b>VAVE-C8-1R8</b>	
			Plug M8, 4-pin	<b>573194</b>	<b>VAVE-C8-1R1</b>	

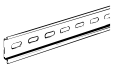

# Solenoid valves MHA3, fast-switching valves

FESTO

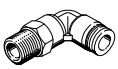
Technical data – Sub-base valve

Ordering data					
				Part No.	Type
<b>H-rail mounting</b>					
	For manifold block			<b>162556</b>	<b>CPV10/14-VI-BG-NRH-35</b>
<b>H-rail</b>					
	To EN 60715	2 m		<b>35430</b>	<b>NRH-35-2000</b>
<b>Silencer</b> <span style="float: right;">Technical data → Internet: uc</span>					
	With threaded connection	G1/8	1 piece	<b>161419</b>	<b>UC-1/8</b>
			50 pieces	<b>534219</b>	<b>UC-1/8-50</b>
		G1/4	1 piece	<b>165004</b>	<b>UC-1/4</b>
			20 pieces	<b>534220</b>	<b>UC-1/4-20</b>
<b>Push-in fitting</b> <span style="float: right;">Technical data → Internet: qs</span>					
	Male thread G1/8 with external hex for tubing O.D.	6 mm	10 pieces	<b>186096</b>	<b>QS-G1/8-6</b>
			100 pieces	<b>132037</b>	<b>QS-G1/8-6-100</b>
		8 mm	10 pieces	<b>186098</b>	<b>QS-G1/8-8</b>
			50 pieces	<b>132038</b>	<b>QS-G1/8-8-50</b>
	Male thread G1/4 with external hex for tubing O.D.	8 mm	10 pieces	<b>186099</b>	<b>QS-G1/4-8</b>
			50 pieces	<b>132040</b>	<b>QS-G1/4-8-50</b>
		10 mm	10 pieces	<b>186101</b>	<b>QS-G1/4-10</b>
			50 pieces	<b>132041</b>	<b>QS-G1/4-10-50</b>
	Male thread G1/8 with external hex, push-in L-fitting rotatable through 360° for tubing O.D.	6 mm	10 pieces	<b>186117</b>	<b>QSL-G1/8-6</b>
			100 pieces	<b>132049</b>	<b>QSL-G1/8-6-100</b>
		8 mm	10 pieces	<b>186119</b>	<b>QSL-G1/8-8</b>
			50 pieces	<b>132050</b>	<b>QSL-G1/8-8-50</b>
	Male thread G1/4 with external hex, push-in L-fitting rotatable through 360° for tubing O.D.	8 mm	10 pieces	<b>186120</b>	<b>QSL-G1/4-8</b>
			50 pieces	<b>132052</b>	<b>QSL-G1/4-8-50</b>
		10 mm	10 pieces	<b>186122</b>	<b>QSL-G1/4-10</b>
			50 pieces	<b>132053</b>	<b>QSL-G1/4-10-50</b>
<b>Blanking plug</b>					
	For thread G1/8		10 pieces	<b>3568</b>	<b>B-1/8</b>
	For thread G1/4		10 pieces	<b>3569</b>	<b>B-1/4</b>
<b>Inscription label</b>					
	For solenoid valve		80 pieces in frame	<b>197259</b>	<b>MH-BZ-80X</b>

# Solenoid valves MH4, fast-switching valves

Type codes

MH P 4 - M S 1 H - 3/2 - 0 - QS-8

Valve series	
MH	Fast-switching valves

Design	
E	Individual valve
P	Semi in-line valve
A	Sub-base valve

Size	
4	Flow rate 400 l/min

Drive system	
M	Solenoid, switching

Switching time	
-	10.5 ms
S	3.5 ms

Operating voltage	
1	24 V DC

Manual override	
H	Non-detenting

Valve function	
3/2	3/2-way valve

Normal position	
G	Closed
0	Open

Pneumatic connection	
4	Nominal width 4 mm
1/4	Thread G1/4
QS-8	Push-in connector for tubing O.D. 8 mm

Electrical connection	
-	Plug vanes for plug socket KMEB
K	Moulded-in cable, 2.5 m long

# Solenoid valves MHE4, fast-switching valves

Peripherals overview – Individual valve

Connection with plug vanes – Connection with moulded-in cable

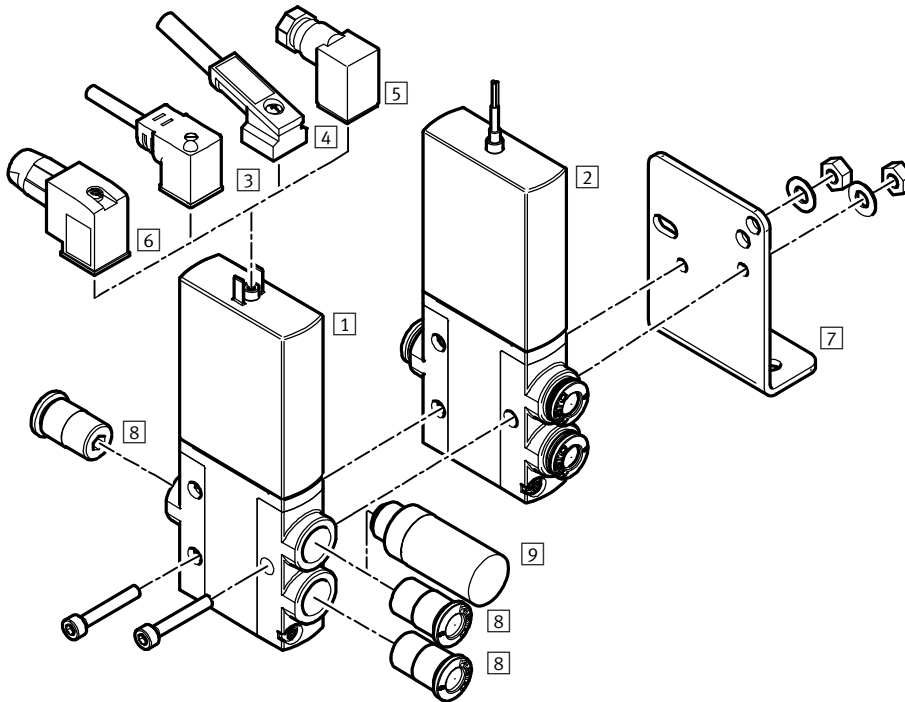

Designation	Brief description	→ Page/Internet
1 Individual valve MHE4	With plug vanes	87
2 Individual valve MHE4-...-K	With cable	87
3 Plug socket with cable KMEB-1 (IP65)	PVC cable, with or without LED	88
4 Plug socket with cable KMEB-2 (IP65)	With LED, without LED; PUR cable, with or without LED	88
5 Plug socket MSSD-EB (IP65)	With clamping screw	88
6 Plug socket MSSD-EB-S-M14 (IP65)	With insulation displacement connector	88
7 Mounting bracket MHE2-BG-L	For wall mounting	88
8 Push-in fittings QS	For connecting compressed air tubing with standard O.D.	88
9 Silencer UC	For mounting in exhaust ports	88

# Solenoid valves MHE4, fast-switching valves

Technical data – Individual valve

FESTO

Function

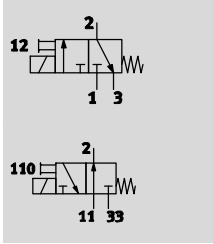

-  - Voltage  
24 V DC

-  - Pressure  
-0.9 ... +8 bar

-  - Temperature range  
-5 ... +60 °C



General technical data		
Valve function		3/2 way, single solenoid <sup>1)</sup>
Design		Pressure-relieved poppet valve
Sealing principle		Soft
Reset method		Mechanical spring
Actuation type		Electric
Type of control		Direct
Direction of flow		Reversible with restrictions <sup>2)</sup>
Exhaust air function		With flow control
Manual override		Non-detenting
Mounting position		Any
Width	[mm]	18
Grid dimension	[mm]	24
Nominal width	[mm]	4
Standard nominal flow rate	[l/min]	400
Type of mounting		Via through-holes
Pneumatic connection		Connecting thread G1/4
		Push-in connector for tubing O.D. 8 mm
Product weight	[g]	270

- 1) Can be used as a 2/2-way valve by sealing port 3 or 33  
 2) Slight leakage can occur in the pressure range -0.8 bar to +0.5 bar.

Operating and environmental conditions			With fast-switching electronics	Without fast-switching electronics
Operating medium			Compressed air to ISO 8573-1:2010 [7:4:4]	
Note on operating/pilot medium			Lubricated operation possible (in which case lubricated operation will always be required)	
Operating pressure		[bar]	-0.9 ... +8	
	Reversible	[bar]	-0.9 ... +1	
Ambient temperature		[°C]	-5 ... +60	
Temperature of medium		[°C]	-5 ... +60	
Corrosion resistance class CRC <sup>1)</sup>			2	
CE marking (see declaration of conformity)			To EU EMC Directive <sup>2)</sup>	-
Certification			c UL us Recognized (OL)	c UL us Recognized (OL)
			RCM trademark	-

- 1) Corrosion resistance class 2 according to Festo standard 940 070  
 Components subject to moderate corrosion stress. Externally visible parts with primarily decorative surface requirements which are in direct contact with a normal industrial environment or media such as coolants or lubricating agents.  
 2) For information about the applicability of the component see the manufacturer's EC declaration of conformity at: [www.festo.com/sp](http://www.festo.com/sp) → Certificates.  
 If the component is subject to restrictions on usage in residential, office or commercial environments or small businesses, further measures to reduce the emitted interference may be necessary.

# Solenoid valves MHE4, fast-switching valves

Technical data – Individual valve

Electrical data		With fast-switching electronics	Without fast-switching electronics
Electrical connection		2-pin plug or moulded-in cable	
Operating voltage	[V DC]	24 ±10%	
Power consumption	[W]	8.5 (high-current phase)	5.6
	[W]	2.125 (low-current phase)	–
Protection against incorrect polarity		Bipolar	–
Additional functions		Spark arresting	–
		Holding current reduction	–
		Protective circuit	–
Degree of protection to EN 60529	With moulded-in cable	IP65	IP65
	With plug socket with cable KMEB	IP65	IP65

Response times and switching frequencies		With fast-switching electronics	Without fast-switching electronics
Switching time	On [ms]	3.5 +10% ... –30%	10.5
	Off [ms]	3.5 +10% ... –40%	5
Switching time variation at 1 Hz and above	[ms]	0.3	–
Maximum switching frequency	[Hz]	210	120

Safety data	
Resistance to shocks	Shock test with severity level 2 to FN 942017-5 and EN 60068-2-27
Vibration resistance	Transport application test with severity level 2 to FN 942017-4 and EN 60068-2-6

## Materials

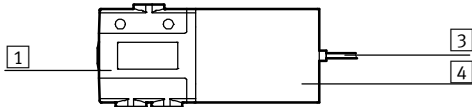

1	Housing	Die-cast zinc, coated
3	Cable sheath	PUR
4	Coil housing	PA
–	Seals	NBR, HNBR
–	Screws	Galvanised steel
Note on materials		Free of copper and PTFE RoHS-compliant

## Current curve for valves with fast-switching electronics (MHE4-MS1H)

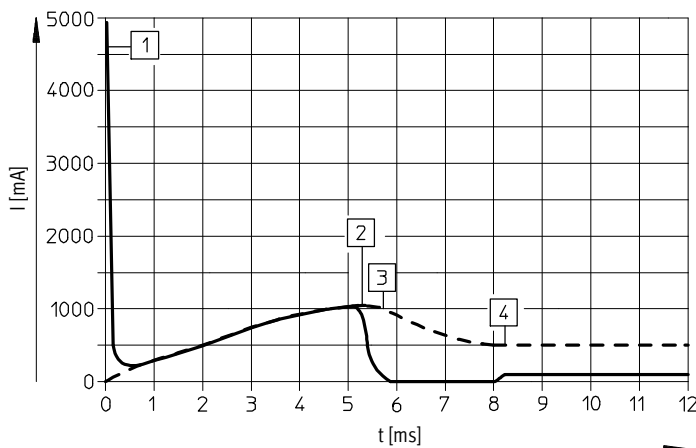

--- Internal current in the coil  
 — External current in the supply line

- 1 Capacitor charging
- 2 Controlled coil current 1 A
- 3 Reduction to holding current
- 4 Controlled holding current 0.5 A

# Solenoid valves MHE4, fast-switching valves

Technical data – Individual valve



## Dimensions

Download CAD data → [www.festo.com](http://www.festo.com)

Valve with plug vanes or moulded-in cable

MHE4-...-1/4-...

MHE4-...-QS-8-...

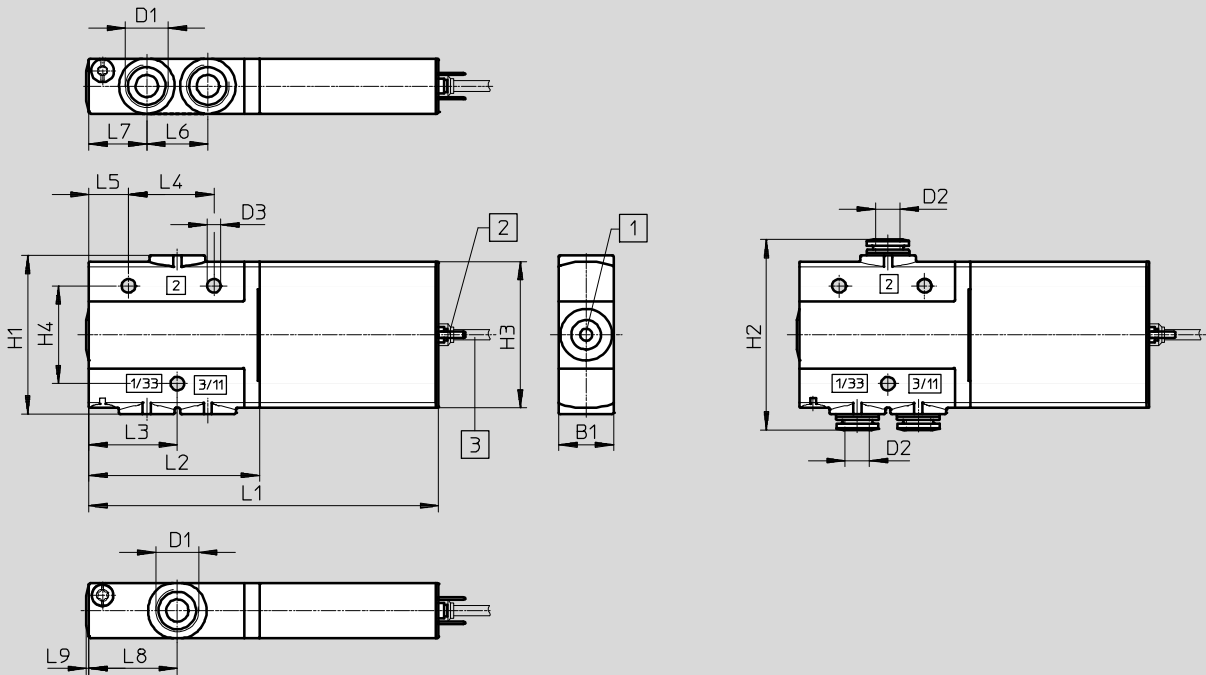

- 1 Manual override, non-detenting
- 2 Plug vanes
- 3 Cable 2.5 m

## Mounting bracket MHE2-BG-L

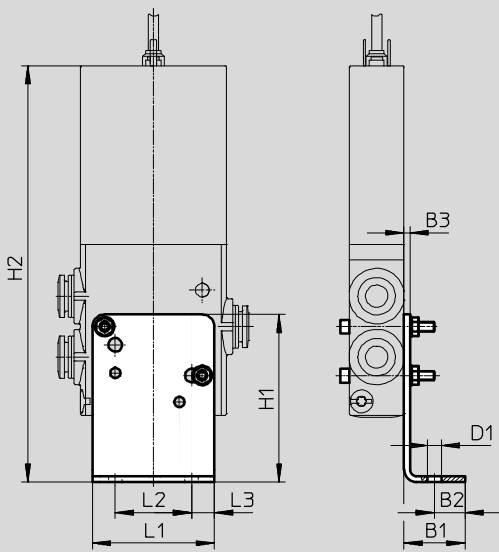

Type	B1	B2	B3	D1	D2 Ø	D3 Ø	H1	H2	H3	H4	L1	L2	L3	L4	L5	L6	L7	L8	L9
MHE4-...-1/4-...	18	-	-	G1/4	-	4.5	56	-	48	32	114.6	56	29	28	13	20	19	29	0.8
MHE4-...-QS-8-...	18	-	-	-	8	4.5	52	62.4	48	32	114.6	56	29	28	13	20	19	29	0.8
MHE2-BG-L	20	10	2	4.5	-	-	55	134	-	-	40	25	7.5	-	-	-	-	-	-





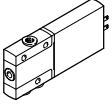
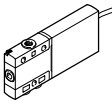





# Solenoid valves MHE4, fast-switching valves

Technical data – Individual valve

Ordering data					Part No.	Type
Valves						
	Electrical connection: plug vanes	With fast-switching electronics, switching time 3.5 ms	Pneumatic connection: thread G1/4	Normally open	<b>525207</b>	<b>MHE4-MS1H-3/20-1/4</b>
				Normally closed	<b>525187</b>	<b>MHE4-MS1H-3/2G-1/4</b>
			Pneumatic connection: push-in connector for tubing O.D. 8 mm	Normally open	<b>525211</b>	<b>MHE4-MS1H-3/20-QS-8</b>
				Normally closed	<b>525191</b>	<b>MHE4-MS1H-3/2G-QS-8</b>
		Without fast-switching electronics, switching time 10.5 ms	Pneumatic connection: thread G1/4	Normally open	<b>525206</b>	<b>MHE4-M1H-3/20-1/4</b>
				Normally closed	<b>525186</b>	<b>MHE4-M1H-3/2G-1/4</b>
			Pneumatic connection: push-in connector for tubing O.D. 8 mm	Normally open	<b>525210</b>	<b>MHE4-M1H-3/20-QS-8</b>
				Normally closed	<b>525190</b>	<b>MHE4-M1H-3/2G-QS-8</b>
	Electrical connection: cable	With fast-switching electronics, switching time 3.5 ms	Pneumatic connection: thread G1/4	Normally closed	<b>525189</b>	<b>MHE4-MS1H-3/2G-1/4-K</b>
				Pneumatic connection: push-in connector for tubing O.D. 8 mm	Normally open	<b>525213</b>
			Normally closed		<b>525193</b>	<b>MHE4-MS1H-3/2G-QS-8-K</b>
			Without fast-switching electronics, switching time 10.5 ms	Pneumatic connection: thread G1/4	Normally open	<b>525208</b>
		Normally closed			<b>525188</b>	<b>MHE4-M1H-3/2G-1/4-K</b>

# Solenoid valves MHE4, fast-switching valves

Technical data – Individual valve

Ordering data					Part No.	Type
Plug socket with cable (for valves with plug vanes)						
	3-pin socket, open cable end 3-wire Signal status display with LED	PVC cable, degree of protection IP65	2.5 m long	<b>151688</b>	<b>KMEB-1-24-2,5-LED</b>	
			5 m long	<b>151689</b>	<b>KMEB-1-24-5-LED</b>	
			10 m long	<b>193457</b>	<b>KMEB-1-24-10-LED</b>	
	4-pin socket, open cable end 3-wire Signal status display with LED	PUR cable, degree of protection IP65	2.5 m long	<b>174844</b>	<b>KMEB-2-24-2,5-LED</b>	
			5 m long	<b>174845</b>	<b>KMEB-2-24-5-LED</b>	
	5-pin socket, plug M12 5-pin Signal status display with LED	Cable sheath TPE-U (PU), degree of protection IP65	0.5 m long	<b>177677</b>	<b>KMEB-2-24-M12-0,5-LED</b>	
Plug socket (for valves with plug vanes)						
	Angled socket, without signal status display	Screw terminal Degree of protection IP65	3-pin	<b>151687</b>	<b>MSSD-EB</b>	
		Insulation displacement connection Degree of protection IP67	4-pin	<b>192745</b>	<b>MSSD-EB-S-M14</b>	
Illuminating seal						
	For mounting between plug socket (without signal status display) and valve			<b>151717</b>	<b>MEB-LD-12-24DC</b>	
Wall mounting						
	Mounting bracket			<b>196165</b>	<b>MHE2-BG-L</b>	
Silencer <span style="float: right;">Technical data → Internet: uc</span>						
	Push-in sleeve	Threaded plug PE	8 mm	1 piece	<b>175611</b>	<b>UC-QS-8H</b>
	Threaded connection, polymer design	Threaded plug PE	G1/4	1 piece	<b>165004</b>	<b>UC-1/4</b>
				20 pieces	<b>534220</b>	<b>UC-1/4-20</b>
Push-in fitting <span style="float: right;">Technical data → Internet: qs</span>						
	Male thread with external hex	G1/4	8 mm	10 pieces	<b>186099</b>	<b>QS-G1/4-8</b>
				50 pieces	<b>132040</b>	<b>QS-G1/4-8-50</b>
			10 mm	10 pieces	<b>186101</b>	<b>QS-G1/4-10</b>
				50 pieces	<b>132041</b>	<b>QS-G1/4-10-50</b>
	Push-in L-fitting, rotatable through 360°, male thread with external hex	G1/4	8 mm	10 pieces	<b>186120</b>	<b>QSL-G1/4-8</b>
				50 pieces	<b>132052</b>	<b>QSL-G1/4-8-50</b>
			10 mm	10 pieces	<b>186122</b>	<b>QSL-G1/4-10</b>
				50 pieces	<b>132053</b>	<b>QSL-G1/4-10-50</b>
Blanking plug						
	For thread G1/4			10 pieces	<b>3569</b>	<b>B-1/4</b>
Inscription label						
	For solenoid valve			80 pieces	<b>197259</b>	<b>MH-BZ-80X</b>



# Solenoid valves MHP4, fast-switching valves

Peripherals overview – Semi in-line valve

## Connection via plug vanes

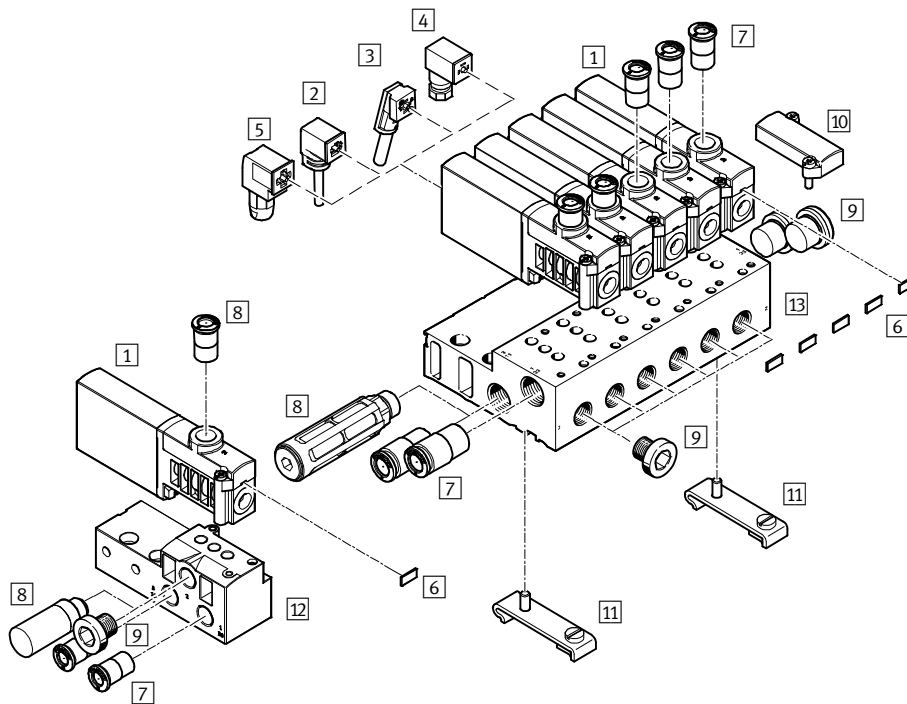

Designation	Brief description	→ Page/Internet
1 Semi in-line valve MHP4	With plug vanes	95
2 Plug socket MSSD-EB (IP65)	With clamping screw	96
3 Plug socket MSSD-EB-S-M14 (IP65)	With insulation displacement connector	96
4 Plug socket with cable KMEB-1 (IP65)	PVC cable, with or without LED	96
5 Plug socket with cable KMEB-2 (IP65)	PUR cable, with or without LED	96
6 Inscription label MH-BZ-80X	For identifying the valves	97
7 Push-in fittings QS	For connecting compressed air tubing with standard O.D.	97
8 Silencer UC	For mounting in exhaust ports	97
9 Blanking plug B	For sealing unused ports	97
10 Cover plate MHAP4-BP-3	For sealing vacant positions	95
11 H-rail mounting CPV10/14-VI-BG-NRH-35	For mounting the manifold block on H-rails according to EN 60715	96
12 Individual sub-base MHA4-AS-3-1/4	For semi in-line valves; the individual sub-base is also used for sub-base valves and must be sealed with a blanking plug here	95
13 Manifold block MHA4-PR...-1/4	For semi in-line valves	95

# Solenoid valves MHP4, fast-switching valves

Technical data – Semi in-line valve

FESTO

Function

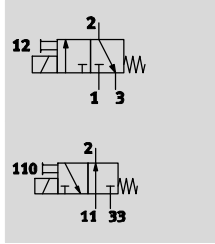

-  - Voltage  
24 V DC

-  - Pressure  
-0.9 ... +8 bar

-  - Temperature range  
-5 ... +40 °C



General technical data		
Valve function		3/2 way, single solenoid <sup>1)</sup>
Design		Pressure-relieved poppet valve
Sealing principle		Soft
Reset method		Mechanical spring
Actuation type		Electric
Type of control		Direct
Direction of flow		Reversible with restrictions <sup>2)</sup>
Exhaust air function		With flow control
Manual override		Non-detenting
Mounting position		Any
Width	[mm]	18
Grid dimension	[mm]	24
Nominal width	[mm]	4
Standard nominal flow rate	[l/min]	400
Type of mounting		On PR rail
Pneumatic connection	2 1, 11, 3, 33	Connecting thread G1/4, push-in connector for tubing O.D. 8 mm Sub-base
Product weight	[g]	270

1) Can be used as a 2/2-way valve by sealing port 3 or 33

2) Slight leakage can occur in the pressure range -0.8 bar to +0.5 bar.

Operating and environmental conditions			With fast-switching electronics	Without fast-switching electronics
Operating medium			Compressed air to ISO 8573-1:2010 [7:4:4]	
Note on operating/pilot medium			Lubricated operation possible (in which case lubricated operation will always be required)	
Operating pressure	[bar]		-0.9 ... +8	
	Reversible	[bar]	-0.9 ... +1	
Ambient temperature	[°C]		-5 ... +40	
Temperature of medium	[°C]		-5 ... +40	
Corrosion resistance class CRC <sup>1)</sup>			2	
CE marking (see declaration of conformity)			To EU EMC Directive <sup>2)</sup>	-
Certification			c UL us Recognized (OL) RCM trademark	c UL us Recognized (OL) -

1) Corrosion resistance class 2 according to Festo standard 940 070

Components subject to moderate corrosion stress. Externally visible parts with primarily decorative surface requirements which are in direct contact with a normal industrial environment or media such as coolants or lubricating agents.

2) For information about the applicability of the component see the manufacturer's EC declaration of conformity at: [www.festo.com/sp](http://www.festo.com/sp) → Certificates.

If the component is subject to restrictions on usage in residential, office or commercial environments or small businesses, further measures to reduce the emitted interference may be necessary.

# Solenoid valves MHP4, fast-switching valves

Technical data – Semi in-line valve

Electrical data		With fast-switching electronics	Without fast-switching electronics
Electrical connection		Plug, 2-pin	
Operating voltage	[V DC]	24 ±10%	
Power consumption	[W]	8.5 (high-current phase)	5.6
	[W]	2.125 (low-current phase)	–
Protection against incorrect polarity		Bipolar	–
Additional functions		Spark arresting	–
		Holding current reduction	–
		Protective circuit	–
Degree of protection to EN 60529	With plug socket with cable KMEB	IP65	IP65

Response times and switching frequencies				With fast-switching electronics	Without fast-switching electronics
Switching time	On	[ms]		3.5 +10% ... –30%	10.5
	Off	[ms]		3.5 +10% ... –40%	5
Switching time variation at 1 Hz and above		[ms]		0.3	–
Maximum switching frequency		[Hz]		210	120

Safety data	
Resistance to shocks	Shock test with severity level 2 to FN 942017-5 and EN 60068-2-27
Vibration resistance	Transport application test with severity level 2 to FN 942017-4 and EN 60068-2-6

## Materials

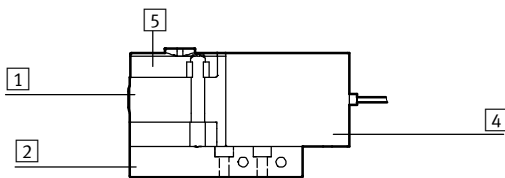

1	Housing	Die-cast zinc, coated
2	Sub-base	Aluminium in the case of the manifold, die-cast zinc in the case of the individual sub-base
4	Coil housing	PA
5	Manifold rail	PA
–	Seals	NBR, HNBR
–	Screws	Galvanised steel
	Note on materials	Free of copper and PTFE
		RoHS-compliant

# Solenoid valves MHP4, fast-switching valves

Technical data – Semi in-line valve



## Current curve for valves with fast-switching electronics (MHP4-MS1H)

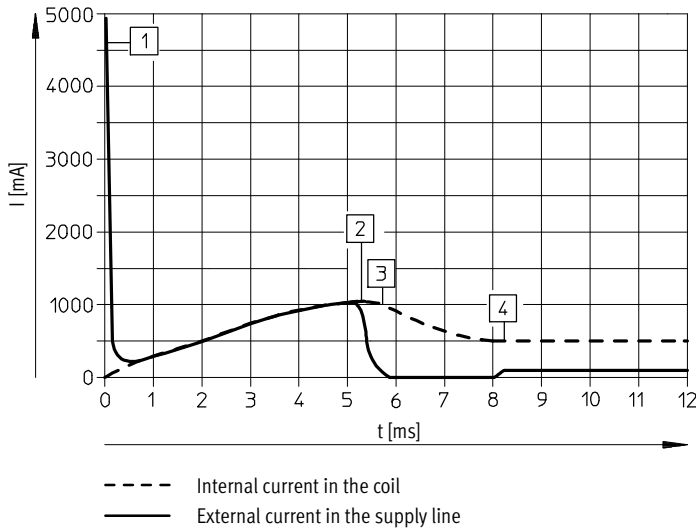

- 1 Capacitor charging
- 2 Controlled coil current 1 A
- 3 Reduction to holding current
- 4 Controlled holding current 0.5 A

## Dimensions

Download CAD data → [www.festo.com](http://www.festo.com)

Valve with connecting thread G1/4

Valve with push-in connector for tubing O.D. 8 mm

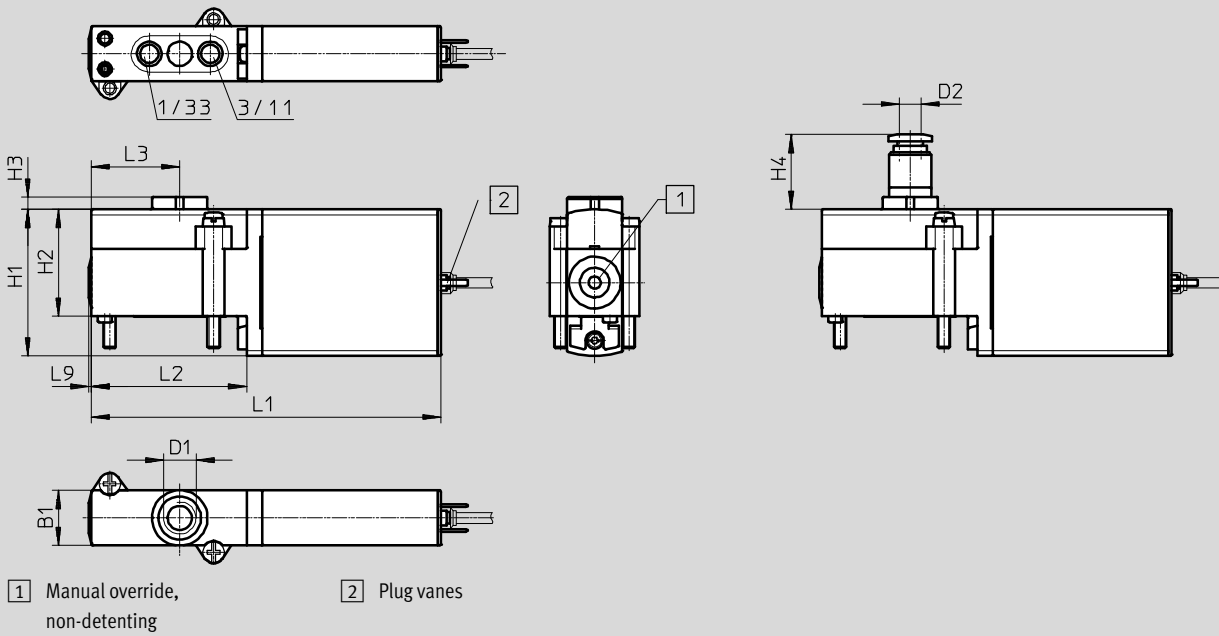

Type	B1	D1	D2 ∅	H1	H2	H3	H4	L1	L2	L3	L9
MHP4-...-3/2...	18	G1/4	8	48	35	4	24.5	114.6	51	29	0.8

# Solenoid valves MHP4, fast-switching valves

Technical data – Semi in-line valve

## Dimensions

Download CAD data → [www.festo.com](http://www.festo.com)

Hole pattern on sub-bases

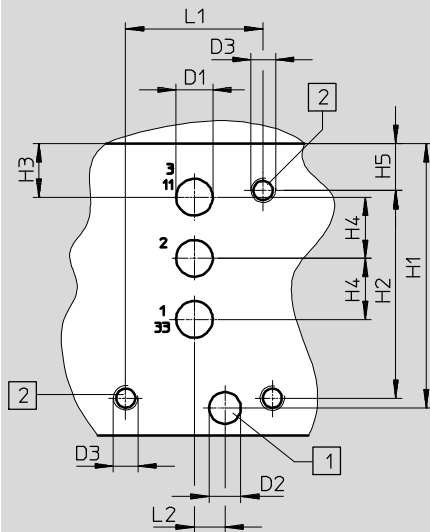

-  - Note

With semi in-line valves, port 2 is not used.  
If used as a 2/2-way valve, normally closed, ports 3/11 are not used.  
If used as a 2/2-way valve, normally open, ports 1/33 are not used.

- 1 Drill hole for coding pin, 2.5 mm deep
- 2 Mounting thread, 13 mm deep

Individual sub-base, MHA4-AS-3-1/4

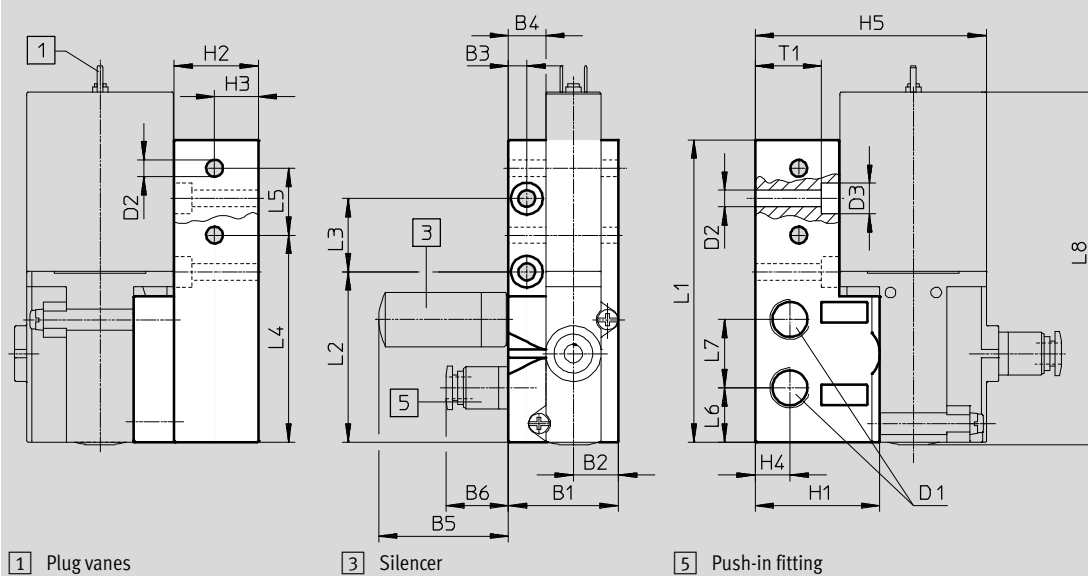

1 Plug vanes

3 Silencer

5 Push-in fitting

Type	B1	B2	B3	B4	B5	B6	D1	D2	D3	H1	H2	H3	H4	H5
Hole pattern	-	-	-	-	-	-	6	5.2	M4	43.3	34	8.8	10	7.7
MHA4-AS-3-1/4	36	14.8	6	12.3	42.5	20.5	G1/4	5.5	10	31	27.5	14.3	11.4	75.8

Type	L1	L2	L3	L4	L5	L6	L7	L8	T1
Hole pattern	22.5	5	-	-	-	-	-	-	-
MHA4-AS-3-1/4	99	55.8	24	67.8	21.9	17.8	22.4	115.4	21.8

# Solenoid valves MHP4, fast-switching valves

Technical data – Semi in-line valve



## Dimensions

Download CAD data → [www.festo.com](http://www.festo.com)

Manifold assembly, MHA4-PR...-1/4

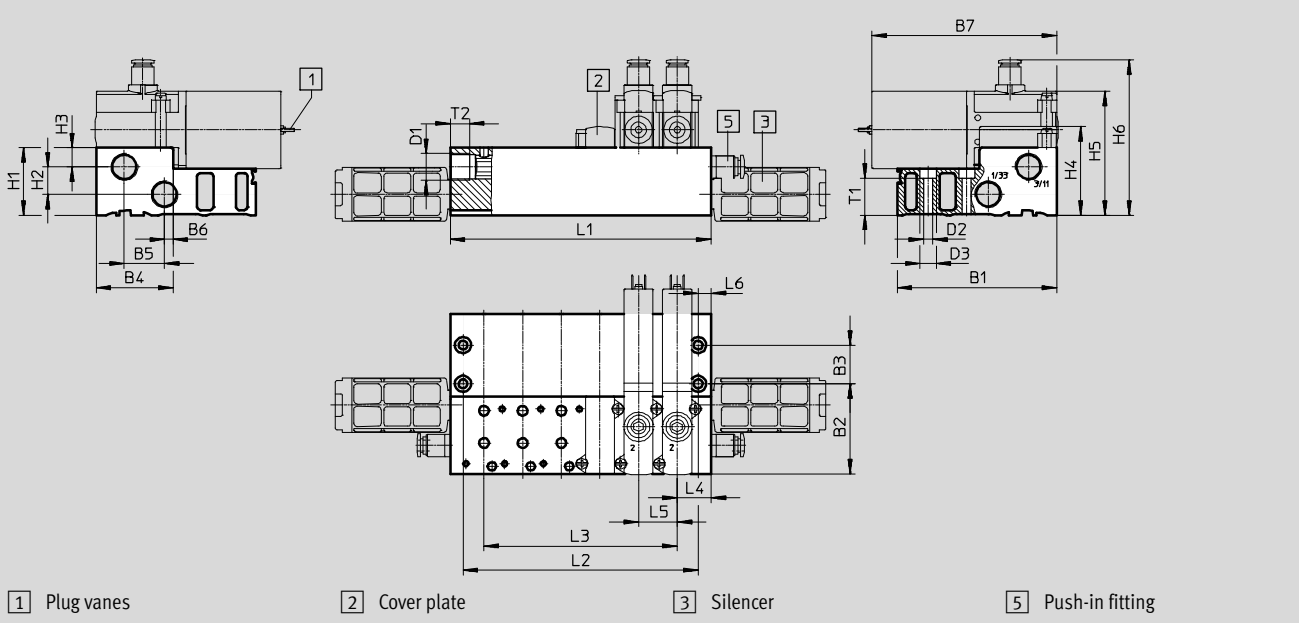

H-rail mounting CPV10/14-VI-BG-NRH-35

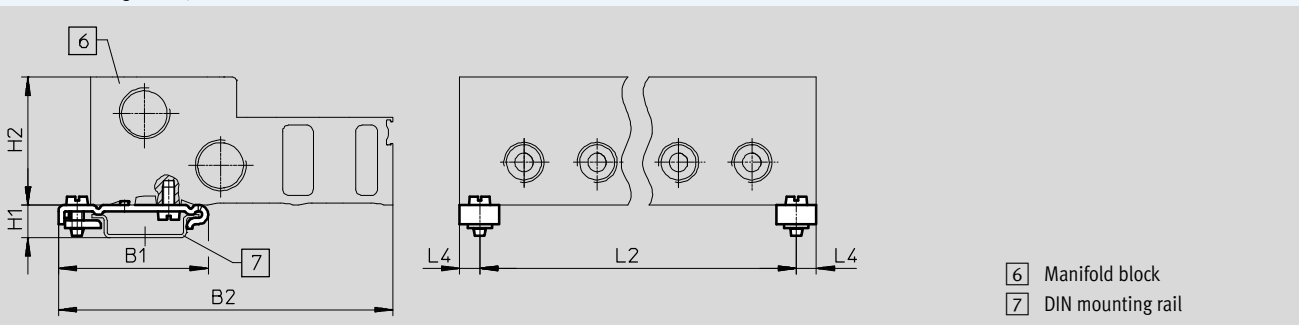





Type	B1	B2	B3	B4	B5	B6	B7	D1	D2	D3	H1	H2	H3	H4	H5	H6	L4	L5	L6	T1	T2
MHA4-PR...-1/4	99	55.8	24	47.8	25	5.3	114.6	G3/8	5.5	10	42	17	12	55	77	96.5	21	24	8	23	12
CPV10/14-VI-BG...	49.1	110	-	-	-	-	-	-	-	-	10.7	42	-	-	-	-	6.5	-	-	-	-

Type		Number of valve positions				
		2	4	6	8	10
MHA4-PR...-1/4	L1	66	114	162	210	258
	L2	50	98	146	194	242
	L3	24	72	120	168	216
CPV10/14-VI-BG...	L2	53	101	149	197	245

- - Note  
 Valve types 3.2G and 3/20 must not be mixed on one manifold block.

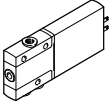
# Solenoid valves MHP4, fast-switching valves

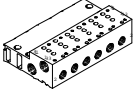
Technical data – Semi in-line valve







Ordering data					Part No.	Type
<b>Valves</b>						
	Electrical connection: plug vanes	With fast-switching electronics, switching time 3.5 ms	Pneumatic connection: thread G1/4	Normally open	<b>525199</b>	<b>MHP4-MS1H-3/20-1/4</b>
				Normally closed	<b>525179</b>	<b>MHP4-MS1H-3/2G-1/4</b>
			Pneumatic connection: push-in connector for tubing O.D. 8 mm	Normally closed	<b>525183</b>	<b>MHP4-MS1H-3/2G-QS-8</b>
		Without fast-switching electronics, switching time 10.5 ms	Pneumatic connection: thread G1/4	Normally open	<b>525198</b>	<b>MHP4-M1H-3/20-1/4</b>
				Normally closed	<b>525178</b>	<b>MHP4-M1H-3/2G-1/4</b>
<b>Manifold rail</b>						
	Individual sub-base <sup>1)</sup> Pneumatic connection: thread G1/4		1 valve position	<b>525227</b>	<b>MHA4-AS-3-1/4</b>	
	Manifold block <sup>1)</sup> Pneumatic connection 1, 11, 3, 33: thread G3/8 Pneumatic connection 2: thread G1/4		2 valve positions	<b>525234</b>	<b>MHA4-PR2-3-1/4</b>	
			4 valve positions	<b>525235</b>	<b>MHA4-PR4-3-1/4</b>	
			6 valve positions	<b>525236</b>	<b>MHA4-PR6-3-1/4</b>	
			8 valve positions	<b>525237</b>	<b>MHA4-PR8-3-1/4</b>	
			10 valve positions	<b>525238</b>	<b>MHA4-PR10-3-1/4</b>	
<b>Cover plate</b>						
	Vacant valve positions must be sealed with a cover plate				<b>525239</b>	<b>MHAP4-BP-3</b>

1) Seal port 2 with a blanking plug. These ports have no function when using semi in-line valves.

 Note  
Valve types 3/2G and 3/2O must not be mixed on one manifold block.

# Solenoid valves MHP4, fast-switching valves





Technical data – Semi in-line valve

Ordering data				Part No.	Type
Plug socket with cable (for valves with plug vanes)					
	3-pin socket, open cable end 3-wire Signal status display with LED	PVC cable, degree of protection IP65	Length: 2.5 m	<b>151688</b>	<b>KMEB-1-24-2,5-LED</b>
			Length: 5 m	<b>151689</b>	<b>KMEB-1-24-5-LED</b>
			Length: 10 m	<b>193457</b>	<b>KMEB-1-24-10-LED</b>
	4-pin socket, open cable end 3-wire Signal status display with LED	PUR cable, degree of protection IP65	Length: 2.5 m	<b>174844</b>	<b>KMEB-2-24-2,5-LED</b>
			Length: 5 m	<b>174845</b>	<b>KMEB-2-24-5-LED</b>
	5-pin socket, plug M12 5-pin Signal status display with LED	Cable sheath TPE-U (PU), degree of protection IP65	Length: 0.5 m	<b>177677</b>	<b>KMEB-2-24-M12-0,5-LED</b>
Plug socket (for valves with plug vanes)					
	Angled socket, without signal status display	Screw terminal Degree of protection IP65	3-pin	<b>151687</b>	<b>MSSD-EB</b>
		Insulation displacement connection Degree of protection IP67	4-pin	<b>192745</b>	<b>MSSD-EB-S-M14</b>
Illuminating seal					
	For mounting between plug socket (without signal status display) and valve			<b>151717</b>	<b>MEB-LD-12-24DC</b>
H-rail mounting					
	For manifold block			<b>162556</b>	<b>CPV10/14-VI-BG-NRH-35</b>
H-rail					
	To EN 60715		2 m	<b>35430</b>	<b>NRH-35-2000</b>



# Solenoid valves MHP4, fast-switching valves

Technical data – Semi in-line valve

Ordering data						Part No.	Type
Silencer						Technical data → Internet: uc	
	Push-in sleeve	Threaded plug PE	8 mm	1 piece	<b>175611</b>	<b>UC-QS-8H</b>	
	Threaded connection, polymer design	Threaded plug PE	G1/4	1 piece	<b>165004</b>	<b>UC-1/4</b>	
				20 pieces	<b>534220</b>	<b>UC-1/4-20</b>	
		Housing Polyacetal	G3/8	1 piece	<b>2309</b>	<b>U-3/8</b>	
20 piece	<b>534224</b>			<b>U-3/8-20</b>			
Push-in fitting						Technical data → Internet: qs	
	Male thread with external hex	G1/4	8 mm	10 pieces	<b>186099</b>	<b>QS-G1/4-8</b>	
				50 pieces	<b>132040</b>	<b>QS-G1/4-8-50</b>	
			10 mm	10 pieces	<b>186101</b>	<b>QS-G1/4-10</b>	
		G3/8	10 mm	10 pieces	<b>186102</b>	<b>QS-G3/8-10</b>	
				50 pieces	<b>132044</b>	<b>QS-G3/8-10-50</b>	
			12 mm	10 pieces	<b>186103</b>	<b>QS-G3/8-12</b>	
	Push-in L-fitting, rotatable through 360°, male thread with external hex	G1/4	8 mm	10 pieces	<b>186120</b>	<b>QSL-G1/4-8</b>	
				50 pieces	<b>132052</b>	<b>QSL-G1/4-8-50</b>	
			10 mm	10 pieces	<b>186122</b>	<b>QSL-G1/4-10</b>	
		G3/8	10 mm	10 pieces	<b>186123</b>	<b>QSL-G3/8-10</b>	
				20 pieces	<b>132056</b>	<b>QSL-G3/8-10-20</b>	
			12 mm	10 pieces	<b>186124</b>	<b>QSL-G3/8-12</b>	
20 pieces	<b>132057</b>	<b>QSL-G3/8-12-20</b>					
Blanking plug							
	For thread G1/4			10 pieces	<b>3569</b>	<b>B-1/4</b>	
	For thread G3/8			10 pieces	<b>3570</b>	<b>B-3/8</b>	
Inscription label							
	For solenoid valve			80 pieces	<b>197259</b>	<b>MH-BZ-80X</b>	

# Solenoid valves MHA4, fast-switching valves

Peripherals overview – Sub-base valve

## Connection with plug vanes – Connection with moulded-in cable

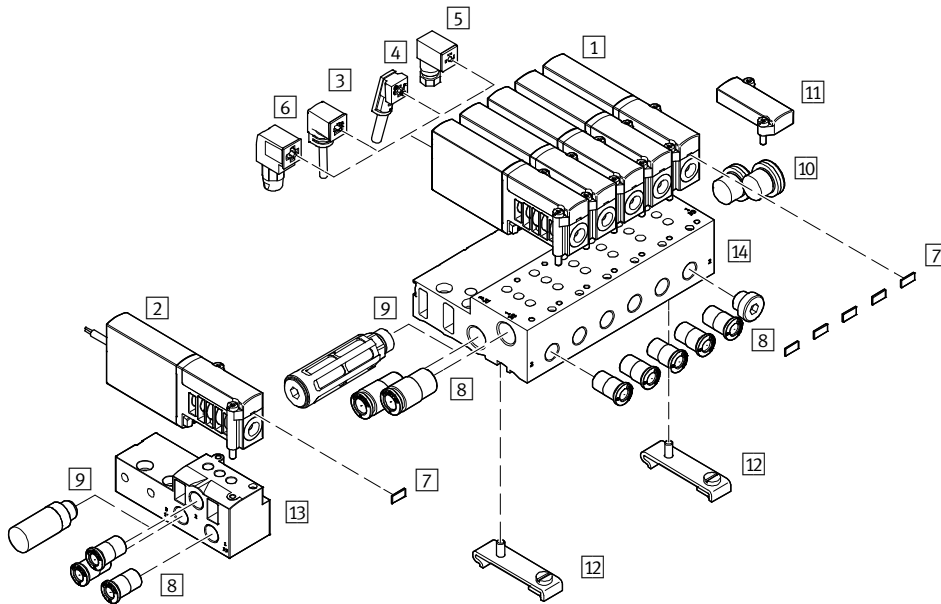





Designation	Brief description	→ Page/Internet
1 Sub-base valves MHA4	With plug vanes	104
2 Sub-base valves MHA4-...-K	With cable	104
3 Plug socket with cable KMEB-1 (IP65)	PVC cable, with or without LED	105
4 Plug socket with cable KMEB-2 (IP65)	PUR cable, with or without LED	105
5 Plug socket MSSD-EB (IP65)	With clamping screw	105
6 Plug socket MSSD-EB-S-M14 (IP65)	With insulation displacement connector	105
7 Inscription label MH-BZ-80X	For identifying the valves	106
8 Push-in fittings QS	For connecting compressed air tubing with standard O.D.	106
9 Silencer UC	For mounting in exhaust ports	106
10 Blanking plug B	For sealing unused ports	106
11 Cover plate MHAP4-BP-3	For sealing vacant positions	104
12 H-rail mounting CPV10/14-VI-BG-NRH-35	For mounting the manifold block on H-rails according to EN 60715	105
13 Individual sub-base MHA4-AS-3-1/4	For sub-base valves	104
14 Manifold block MHA4-PR...-1/4	For sub-base valves	104

# Solenoid valves MHA4, fast-switching valves

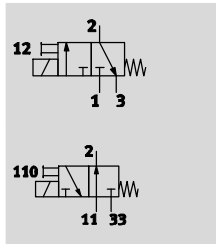
Technical data – Sub-base valve

Function



-  Voltage  
24 V DC
-  Pressure  
-0.9 ... +8 bar
-  Temperature range  
-5 ... +40 °C

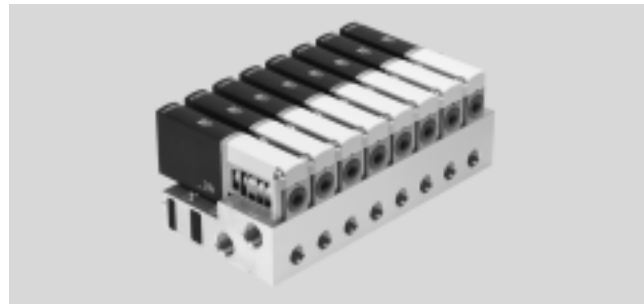

General technical data		
Valve function		3/2 way, single solenoid <sup>1)</sup>
Design		Pressure-relieved poppet valve
Sealing principle		Soft
Reset method		Mechanical spring
Actuation type		Electric
Type of control		Direct
Direction of flow		Reversible with restrictions <sup>2)</sup>
Exhaust air function		With flow control
Manual override		Non-detenting
Mounting position		Any
Width	[mm]	18
Grid dimension	[mm]	24
Nominal width	[mm]	4
Standard nominal flow rate	[l/min]	400
Type of mounting		On PR rail
Pneumatic connection	1, 11, 2, 3, 33	Sub-base
Product weight	[g]	270

- 1) Can be used as a 2/2-way valve by sealing port 3 or 33
- 2) Slight leakage can occur in the pressure range -0.8 bar to +0.5 bar.

Operating and environmental conditions		With fast-switching electronics	Without fast-switching electronics
Operating medium		Compressed air to ISO 8573-1:2010 [7:4:4]	
Note on operating/pilot medium		Lubricated operation possible (in which case lubricated operation will always be required)	
Operating pressure	[bar]	-0.9 ... +8	
	Reversible [bar]	-0.9 ... +1	
Ambient temperature	[°C]	-5 ... +40	
Temperature of medium	[°C]	-5 ... +40	
Corrosion resistance class CRC <sup>1)</sup>		2	
CE marking (see declaration of conformity)		To EU EMC Directive <sup>2)</sup>	-
Certification		c UL us Recognized (OL)	c UL us Recognized (OL)
		RCM trademark	-

- 1) Corrosion resistance class 2 according to Festo standard 940 070  
Components subject to moderate corrosion stress. Externally visible parts with primarily decorative surface requirements which are in direct contact with a normal industrial environment or media such as coolants or lubricating agents.
- 2) For information about the applicability of the component see the manufacturer's EC declaration of conformity at: [www.festo.com/sp](http://www.festo.com/sp) → Certificates.  
If the component is subject to restrictions on usage in residential, office or commercial environments or small businesses, further measures to reduce the emitted interference may be necessary.

# Solenoid valves MHA4, fast-switching valves

Technical data – Sub-base valve

Electrical data		With fast-switching electronics	Without fast-switching electronics
Electrical connection		2-pin plug or moulded-in cable	
Operating voltage	[V DC]	24 ±10%	
Power consumption	[W]	8.5 (high-current phase)	5.6
	[W]	2.125 (low-current phase)	–
Protection against incorrect polarity		Bipolar	–
Additional functions		Spark arresting	–
		Holding current reduction	–
		Protective circuit	–
Degree of protection to EN 60529	With moulded-in cable	IP65	IP65
	With plug socket with cable KMEB	IP65	IP65

Response times and switching frequencies				With fast-switching electronics	Without fast-switching electronics
Switching time	On	[ms]		3.5 +10% ... –30%	10.5
	Off	[ms]		3.5 +10% ... –40%	5
Switching time variation at 1 Hz and above		[ms]		0.3	–
Maximum switching frequency		[Hz]		210	120

Safety data	
Resistance to shocks	Shock test with severity level 2 to FN 942017-5 and EN 60068-2-27
Vibration resistance	Transport application test with severity level 2 to FN 942017-4 and EN 60068-2-6

## Materials

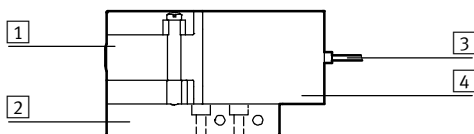

1	Housing	Die-cast zinc, coated
2	Sub-base	Aluminium in the case of the manifold, die-cast zinc in the case of individual sub-base
3	Cable sheath	PUR
4	Coil housing	PA
–	Seals	NBR, HNBR
–	Screws	Galvanised steel
	Note on materials	Free of copper and PTFE RoHS-compliant

# Solenoid valves MHA4, fast-switching valves

Technical data – Sub-base valve

## Current curve for valves with fast-switching electronics (MHA4-MS1H)

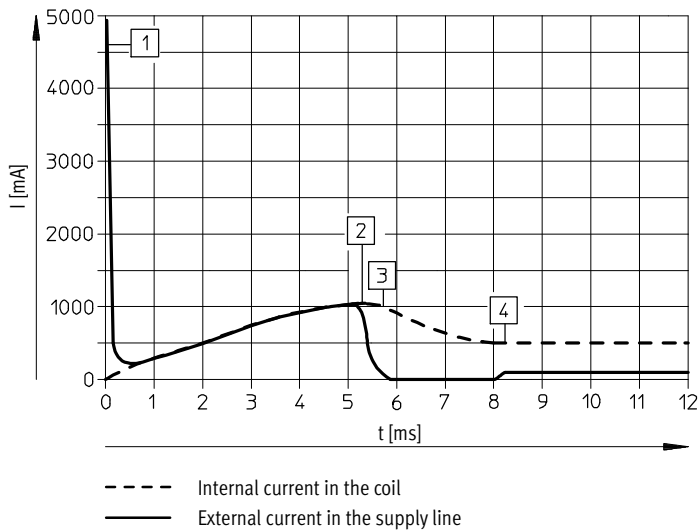

- 1 Capacitor charging
- 2 Controlled coil current 1 A
- 3 Reduction to holding current
- 4 Controlled holding current 0.5 A

## Dimensions

Download CAD data → [www.festo.com](http://www.festo.com)

Valve with plug vanes or moulded-in cable, MHA4-...-3/2...

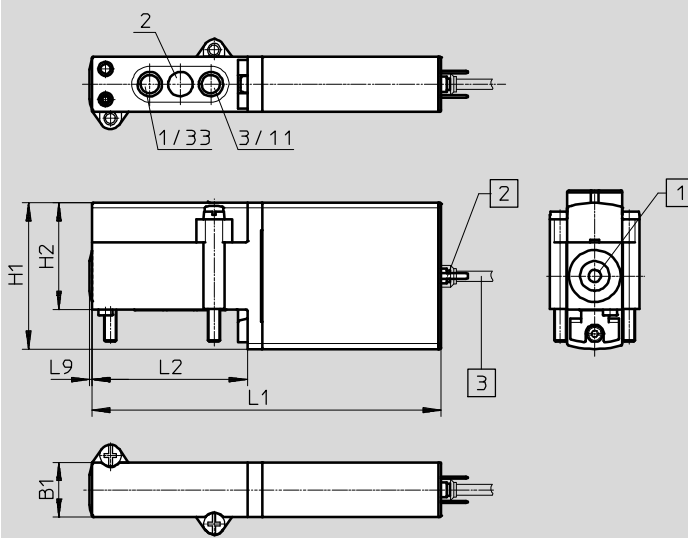

- 1 Manual override, non-detenting
- 2 Plug vanes
- 3 Cable 2.5 m

Type	B1	H1	H2	L1	L2	L9
MHA4-...-3/2...	18	48	35	114.6	51	0.8

# Solenoid valves MHA4, fast-switching valves

Technical data – Sub-base valve



## Dimensions

Download CAD data → [www.festo.com](http://www.festo.com)

Hole pattern on sub-bases

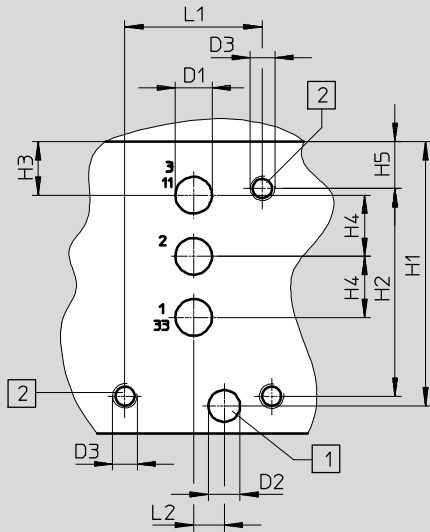

- 1 Drill hole for coding pin, 2.5 mm deep
- 2 Mounting thread, 13 mm deep

Individual sub-base, MHA4-AS-3-1/4

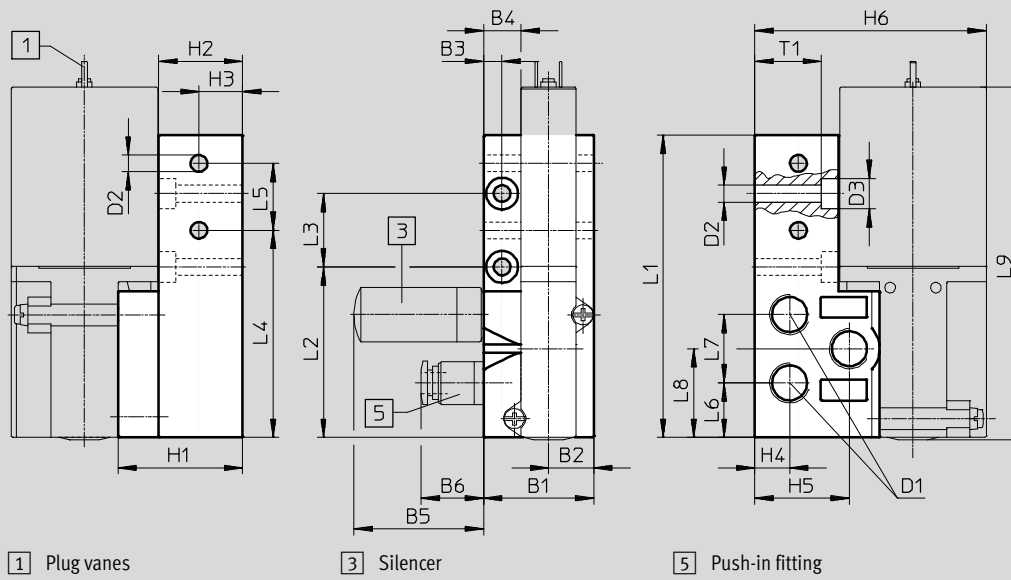

Type	B1	B2	B3	B4	B5	B6	D1	D2 ∅	D3 ∅	H1	H2	H3	H4	H5	H6
Hole pattern	–	–	–	–	–	–	6	5.2	M4	43.3	34	8.8	10	7.7	–
MHA4-AS-3-1/4	36	14.8	6	12.3	42.5	20.5	G1/4	5.5	10	40.8	27.5	14.3	11.4	31	75.8

Type	L1	L2	L3	L4	L5	L6	L7	L8	L9	T1
Hole pattern	22.5	5	–	–	–	–	–	–	–	–
MHA4-AS-3-1/4	99	55.8	24	67.8	21.9	17.8	22.4	29	115.4	21.8

# Solenoid valves MHA4, fast-switching valves

Technical data – Sub-base valve

## Dimensions

Download CAD data → [www.festo.com](http://www.festo.com)

Manifold assembly, MHA4-PR...-1/4

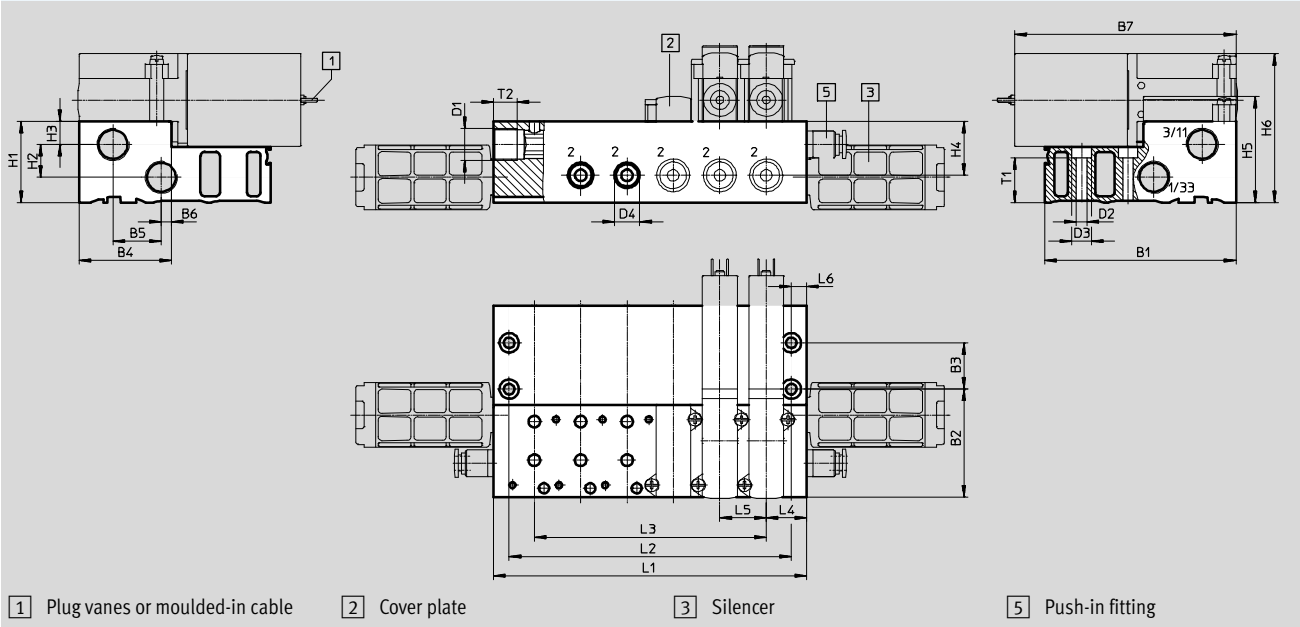

H-rail mounting CPV10/14-VI-BG-NRH-35

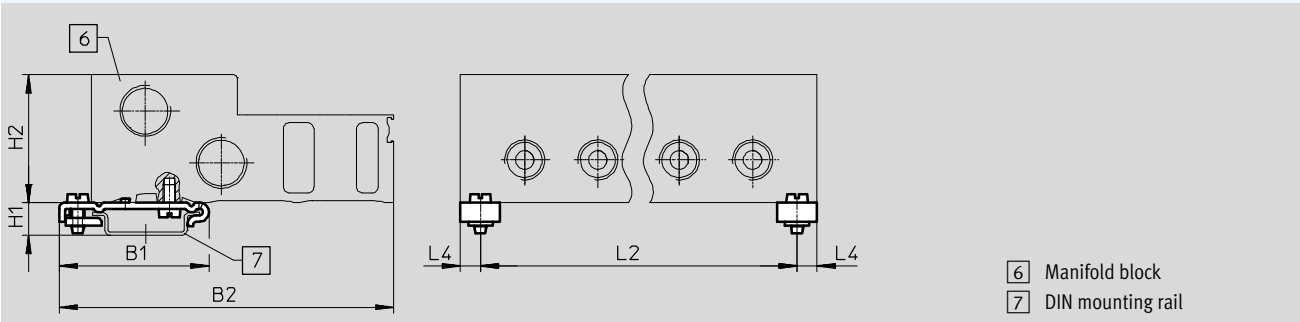





Type	B1	B2	B3	B4	B5	B6	B7	D1	D2	D3	D4	H1	H2	H3	H4	H5	H6
MHA4-PR...-1/4	99	55.8	24	47.8	25	5.3	114.6	G3/8	5.5	10	G1/4	42	17	12	28	55	77
CPV10/14-VI-BG-...	49.1	110	-	-	-	-	-	-	-	-	-	10.7	42	-	-	-	-

Type	L4	L5	L6	T1	T2
MHA4-PR...-1/4	21	24	8	23	12
CPV10/14-VI-BG-...	6.5	-	-	-	-

Type		Number of valve positions				
		2	4	6	8	10
MHA4-PR...-1/4	L1	66	114	162	210	258
	L2	50	98	146	194	242
	L3	24	72	120	168	216
CPV10/14-VI-BG-...	L2	53	101	149	197	245

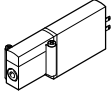
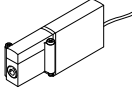
# Solenoid valves MHA4, fast-switching valves

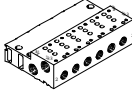
Technical data – Sub-base valve

Ordering data				Part No.	Type
<b>Valves</b>					
	Electrical connection: plug vanes	With fast-switching electronics, switching time 3.5 ms	Normally closed	<b>525175</b>	<b>MHA4-MS1H-3/2G-4</b>
		Without fast-switching electronics, switching time 10.5 ms	Normally closed	<b>525174</b>	<b>MHA4-M1H-3/2G-4</b>
	Electrical connection: cable	With fast-switching electronics, switching time 3.5 ms	Normally closed	<b>525177</b>	<b>MHA4-MS1H-3/2G-4-K</b>
		Without fast-switching electronics, switching time 10.5 ms	Normally open	<b>525196</b>	<b>MHA4-M1H-3/2O-4-K</b>
			Normally closed	<b>525176</b>	<b>MHA4-M1H-3/2G-4-K</b>
<b>Manifold rail</b>					
	Individual sub-base Pneumatic connection: thread G1/4	1 valve position		<b>525227</b>	<b>MHA4-AS-3-1/4</b>
			2 valve positions		<b>525234</b>
4 valve positions			<b>525235</b>	<b>MHA4-PR4-3-1/4</b>	
6 valve positions			<b>525236</b>	<b>MHA4-PR6-3-1/4</b>	
8 valve positions			<b>525237</b>	<b>MHA4-PR8-3-1/4</b>	
10 valve positions			<b>525238</b>	<b>MHA4-PR10-3-1/4</b>	
<b>Cover plate</b>					
	Vacant valve positions must be sealed with a cover plate			<b>525239</b>	<b>MHA4-BP-3</b>







-  - Note

Valve types 3/2G and 3/2O must not be mixed on one manifold block.



# Solenoid valves MHA4, fast-switching valves



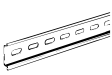

Technical data – Sub-base valve

Ordering data				Part No.	Type
<b>Plug socket with cable (for valves with plug vanes)</b>					
	3-pin socket, open cable end 3-wire Signal status display with LED	PVC cable, degree of protection IP65	2.5 m long	<b>151688</b>	<b>KMEB-1-24-2,5-LED</b>
			5 m long	<b>151689</b>	<b>KMEB-1-24-5-LED</b>
			10 m long	<b>193457</b>	<b>KMEB-1-24-10-LED</b>
	4-pin socket, open cable end 3-wire Signal status display with LED	PUR cable, degree of protection IP65	2.5 m long	<b>174844</b>	<b>KMEB-2-24-2,5-LED</b>
			5 m long	<b>174845</b>	<b>KMEB-2-24-5-LED</b>
	5-pin socket, plug M12 5-pin Signal status display with LED	Cable sheath TPE-U (PU), degree of protection IP65	0.5 m long	<b>177677</b>	<b>KMEB-2-24-M12-0,5-LED</b>
<b>Plug socket (for valves with plug vanes)</b>					
	Angled socket, without signal status display	Screw terminal Degree of protection IP65	3-pin	<b>151687</b>	<b>MSSD-EB</b>
		Insulation displacement connection Degree of protection IP67	4-pin	<b>192745</b>	<b>MSSD-EB-S-M14</b>
<b>Illuminating seal</b>					
	For mounting between plug socket (without signal status display) and valve			<b>151717</b>	<b>MEB-LD-12-24DC</b>
<b>H-rail mounting</b>					
	For manifold block			<b>162556</b>	<b>CPV10/14-VI-BG-NRH-35</b>
<b>H-rail</b>					
	To EN 60715		2 m	<b>35430</b>	<b>NRH-35-2000</b>

# Solenoid valves MHA4, fast-switching valves

FESTO

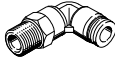
Technical data – Sub-base valve

Ordering data						Part No.	Type
Silencer						Technical data → Internet: uc	
	Push-in sleeve	Threaded plug PE	8 mm	1 piece	<b>175611</b>	<b>UC-QS-8H</b>	
	Threaded connection, polymer design	Threaded plug PE	G1/4	1 piece	<b>165004</b>	<b>UC-1/4</b>	
				20 pieces	<b>534220</b>	<b>UC-1/4-20</b>	
		Housing POM	G3/8	1 piece	<b>2309</b>	<b>U-3/8</b>	
20 pieces	<b>534224</b>			<b>U-3/8-20</b>			
Push-in fitting						Technical data → Internet: qs	
	Male thread with external hex	G1/4	8 mm	10 pieces	<b>186099</b>	<b>QS-G1/4-8</b>	
				50 pieces	<b>132040</b>	<b>QS-G1/4-8-50</b>	
			10 mm	10 pieces	<b>186101</b>	<b>QS-G1/4-10</b>	
				50 pieces	<b>132041</b>	<b>QS-G1/4-10-50</b>	
		G3/8	10 mm	10 pieces	<b>186102</b>	<b>QS-G3/8-10</b>	
				50 pieces	<b>132044</b>	<b>QS-G3/8-10-50</b>	
	Push-in L-fitting, rotatable through 360°, male thread with external hex	G1/4	8 mm	10 pieces	<b>186120</b>	<b>QSL-G1/4-8</b>	
				50 pieces	<b>132052</b>	<b>QSL-G1/4-8-50</b>	
			10 mm	10 pieces	<b>186122</b>	<b>QSL-G1/4-10</b>	
		50 pieces		<b>132053</b>	<b>QSL-G1/4-10-50</b>		
G3/8	10 mm	10 pieces	<b>186123</b>	<b>QSL-G3/8-10</b>			
		20 pieces	<b>132056</b>	<b>QSL-G3/8-10-20</b>			
			12 mm	10 pieces	<b>186124</b>	<b>QSL-G3/8-12</b>	
				20 pieces	<b>132057</b>	<b>QSL-G3/8-12-20</b>	
Blanking plug							
	For thread G1/4			10 pieces	<b>3569</b>	<b>B-1/4</b>	
	For thread G3/8			10 pieces	<b>3570</b>	<b>B-3/8</b>	
Inscription label							
	For solenoid valve			80 pieces	<b>197259</b>	<b>MH-BZ-80X</b>	