

TRANSFORMERS & INDUCTORS



MYRRA
...Of course !

COMPANY PROFILE

Myrra is a major supplier in high quality for electronics components. Myrra has established a worldwide reputation. Myrra design and manufacture high-quality transformers and inductors for industrial use. We supply a blue-chip customer base in a variety of industries, including energy conversion, industrial applications, renewable energy and healthcare. We supply customers all over the world.

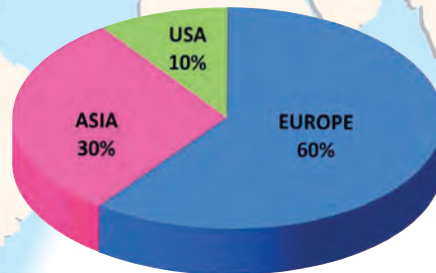

A wide range of products : We offer application specific transformers, inductors, chokes and coils, in three technologies: high frequency, 50Hz technology and electronic, enabling us to serve a number of major markets.

MAGNETICS PRODUCTS

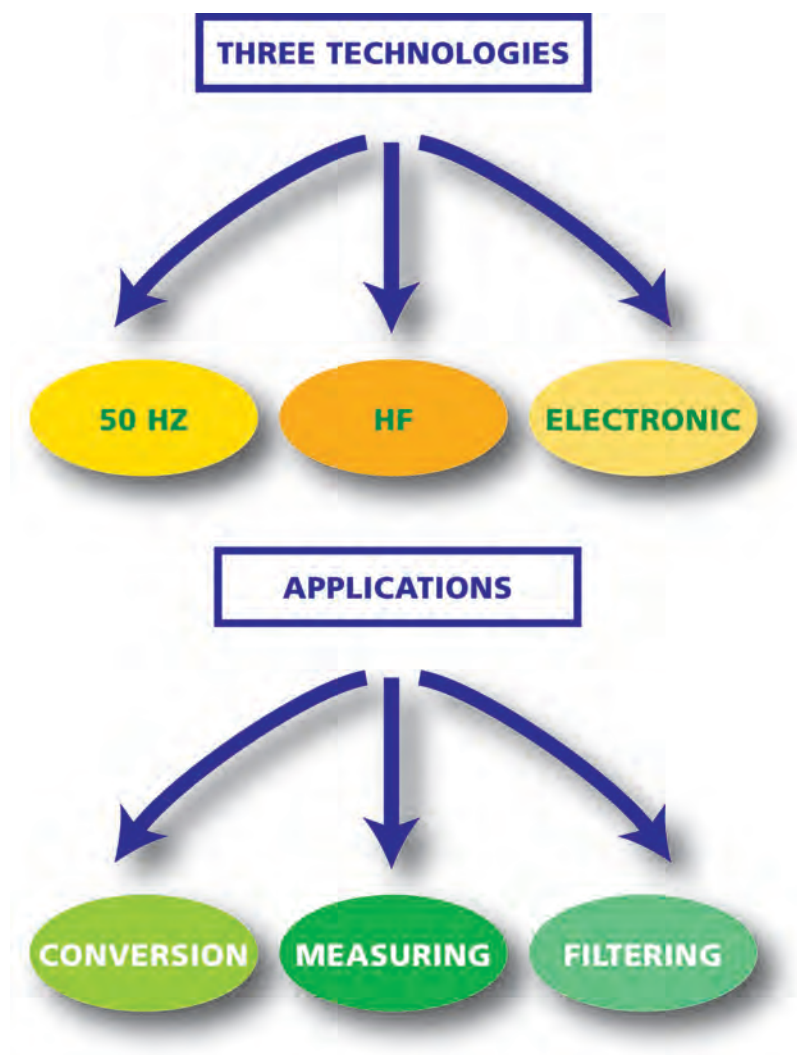



PRODUCT LINES



PCB MAGNETIC COMPONENTS

Encapsulated 50Hz transformers (44 & 45 series)

- * Full range of standard references
- * Isolating safety application
- * UL, VDE, EN61558 certification
- * Automated - 100% tested production

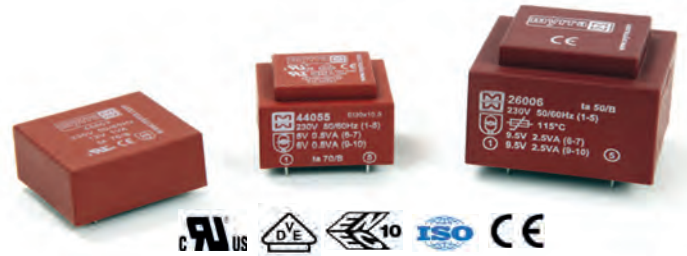

Ferrites core transformers & inductors (74 series)

- * Large application range : flyback transformers, CM chokes etc.
- * International standards compliant
- * Standard products and customized design



Conform to IEC950 IEC335 IEC61558

IT application inductors -THC- SMD type (75-79 series)



Encapsulated POWER SUPPLY (47 series)

- * Pioneering alternative to linear transformers in AC/DC application
- * E130 to E148 size - Input range : 85V-265VAC
- * Regulated output: 3.3VDC-24VDC/ 2.5W-5W-7W-10W-20W-40W-60W
- * Full compliance with Safety, EMC and Immunity standards

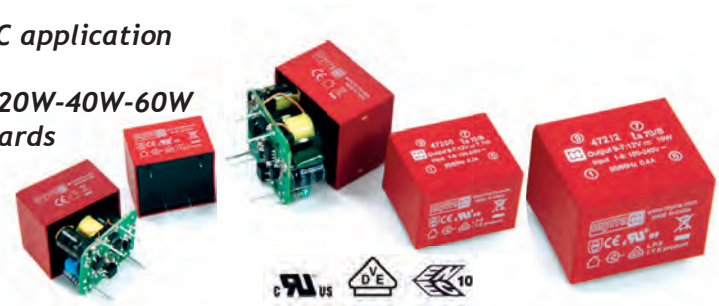

POWER RANGE Transformers and Chokes for specific applications

Lamination and ferrite core

- * Customized design on specification
- * Up to 50kVA for 1000V input range
- * Insulation systems : B, F, H classes
- * UL, IEC, CSA Compliant



Low frequency, High frequency



ISO 9001 2008
ISO 14000



EN60950

EN61558-2-6

MYRRA FRANCE (HQ)

MYRRA DEUTSCHLAND

MYRRA POLAND

MYRRA TURKEY

MYRRA HISPANIA - Comtrafo

MYRRA HONG-KONG

MYRRA ZHONGSHAN (China)

YOUR CONTACT :

Name

Phone

Email



PRODUCT INDEX



TECHNICAL INFORMATIONS	4
■ ENCAPSULATED TRANSFORMERS	5 to 25
44000 SERIES	
0.6 VA to 2.8VA / EI30-5 to EI30-18	5 to 13
3.2VA to 30 VA / EI38 to EI66	14 to 19
WITH OTHER BOXES	20
45000 SERIES	
1 VA to 60 VA	21 to 24
FLF / FLC SERIES	
3.2 VA to 240 VA	25
■ HIGH FREQUENCY FERRITE	26 to 75
POWER FERRITE TRANSFORMERS	26 to 50
FLYBACK TRANSFORMERS RANGE	26
TRANSFORMERS / CONTROL CIRCUITS CROSS REFERENCE LIST	27
1 W to 12 W EE16	28 to 38
10 W to 30 W EL19 EF20 EE25	39 to 42
35 W to 180 W ETD29 to ETD44 ERL28	43 to 47
FLYBACK TRANSFORMERS STANDARD SIZES	48 to 50
COMMON MODE CHOKES FOR EMI SUPPRESSION	51 to 55
TOROIDAL CHOKES	56
CURRENT TRANSFORMERS RANGE	57 to 68
PULSE TRANSFORMER RANGE	69 to 74
POWER LINE COMMUNICATION COUPLING TRANSFORMERS	75 to 77
■ THROUGH HOLES CHOKES / SURFACE MOUNT CHOKES	78
■ ENCAPSULATED POWER SUPPLY	79 to 81
■ CUSTOM POWER PRODUCTS	to 84

TECHNICAL INFORMATION

RATED PRIMARY VOLTAGE (V)

This is the supply voltage assigned to the transformer by the manufacturer.

RATED SECONDARY VOLTAGE (V)

This is the secondary output voltage assigned to the transformer when supplied with the rated primary voltage, frequency range, rated secondary current, all assigned by the manufacturer for the specified operating conditions of the transformer.

RATED POWER (VA)

The specified power levels in this catalogue are the secondary power levels, in other words, those available when the transformer is loaded. It is the product of the RMS rated secondary voltage by the RMS rated current. If the transformer has more than one output winding, the rated power denotes the maximum sum of the products of RMS rated secondary voltage by the RMS rated secondary current, respectively. This rated power is defined for rated ambient temperature conditions.

example : $P = 3,2 \text{ VA ta } 70/B$

The transformer can deliver 3.2VA at maximum ambient (70°C), the load consisting of a resistor load defined by $R(\text{load}) = U(\text{sec})^2/P$ (assigned U sec & P values), heating does not exceed the relevant limit for Class B components used in this construction.

NOTE : When the transformer is intended to supply DC voltage and current in conjunction with rectifiers and smoothing capacitors, the VA power required from the transformer is far higher than the $U(\text{DC})$ and $I(\text{DC})$ product. To help you to determine the true transformer power, our Technical Department is at your disposal.

AMBIENT TEMPERATURE (ta)

The maximum temperature at which the transformer may be operated continuously under nominal conditions of use. It is the air temperature measured close to the transformer after thermal stabilization when operating at rated conditions.

HEATING

The increase of the winding temperature when operating at rated conditions and maximum ambient temperature. The heating must be determined by the resistance method.

TEMPERATURE CLASS

The international classification of temperature classes is as follows :

A	105°C	H	180 °C
E	120°C	200	200 °C
B	130°C	220	220 °C
F	155°C	250	250 °C

It defines the maximum temperature the transformer components must withstand in continuous operation, in compliance with the N° 85 IEC publication classification. There insulating materials are therefore certificated for the thermal index corresponding to the declared class in accordance with N° 216 IEC standard.

PARTICULAR POINTS OF EN 61558-2-6 STANDARD FOR SAFETY TRANSFORMERS

On-load secondary voltage tolerance.

This should not differ from the rated value by more than :

10% for transformers with build-in resistance to short-circuits (a supplement of 5% is granted on the 2nd secondary for transformers with 2 secondaries).

5% for other transformers whatever the secondaries number.

Off-load secondary voltage.

The values given in this catalogue are maximum theoretical values.

NOTE : For safety transformers, this should never exceed 50 V rms. In the case of a transformer with several secondaries, the sum of the secondary voltages should be less than 50 V rms.

ADAPTED TRANSFORMERS FROM THE STANDARDS SERIES

Any transformer whose requires Power and Ambient corresponding to those of our 44000 & 45000 range, and whose secondary voltage can fit in our minimum to maximum secondary range will be covered by EN61558-2-6, EN60950, or UL506 approvals, depending on the effective choice .

SPECIAL TRANSFORMERS

MYRRA can use the 44000, 45000 or 46000 standard ranges to examine any transformer for compliance with your specifications and with international standards.

On request, we can add thermal protection, thermal fuse, thermal switch-CTP.

In certain cases, the addition of thermal protection enables the ambient temperature to be increased, while still complying with EN 61558.

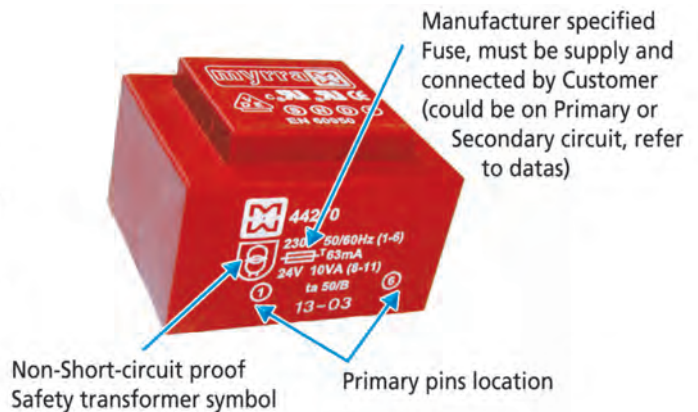
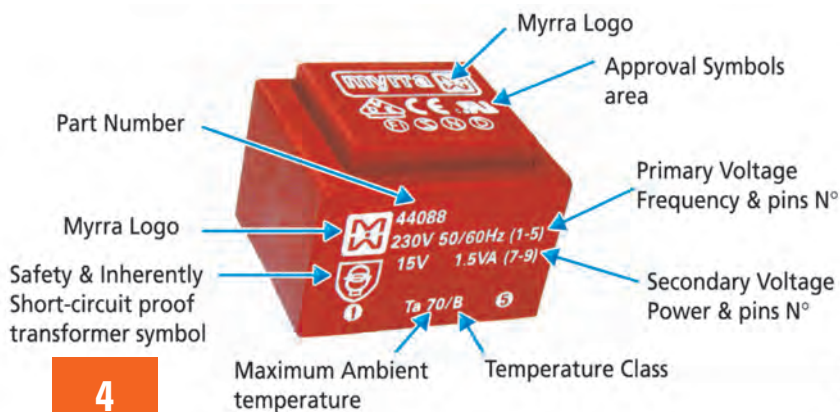



- Vacuum filling
- Two compartments bobbins
- Self-extinguishing plastics UL 94 V0
- Degree of protection IP 00
- 40 grams weight
- Resin class B CEI 85 (20 000 h testing to CEI 126)
- Inherently short-circuits proof
- Insulation voltage 4 KV
- 100 % tested production
- Certification : CCA procedure on request

QUALITY IN SERIES

PRIMARY VOLTAGE 117 V

Protection	Reference	Secondary voltage V	Secondary current mA	No-load voltage V	Ambient Temperature °C	Rating VA
	44025	6	100	9,94	T 70 B	0,6
	44026	9	66	14,95	T 70 B	0,6
	44027	12	50	19,9	T 70 B	0,6
	44028	15	40	24,9	T 70 B	0,6
	44029	18	33	29,9	T 70 B	0,6
	44030	24	25	39,8	T 70 B	0,6
	44031	2 x 6	2 x 50	2 x 9,94	T 70 B	0,6
	44032	2 x 9	2 x 33	2 x 14,95	T 70 B	0,6
	44033	2 x 12	2 x 25	2 x 19,9	T 70 B	0,6
	44034	2 x 15	2 x 20	2 x 24,9	T 70 B	0,6
	44035	2 x 18	2 x 17	2 x 29,9	T 70 B	0,6
	44036	2 x 24	2 x 12	2 x 39,8	T 70 B	0,6

PRIMARY VOLTAGE 230 V

Protection	Reference	Secondary voltage V	Secondary current mA	No-load voltage V	Ambient Temperature °C	Rating VA
	44013	6	100	9,94	T 70 B	0,6
	44014	9	66	14,95	T 70 B	0,6
	44015	12	50	19,9	T 70 B	0,6
	44016	15	40	24,9	T 70 B	0,6
	44017	18	33	29,9	T 70 B	0,6
	44018	24	25	39,8	T 70 B	0,6
	44019	2 x 6	2 x 50	2 x 9,94	T 70 B	0,6
	44020	2 x 9	2 x 33	2 x 14,95	T 70 B	0,6
	44021	2 x 12	2 x 25	2 x 19,9	T 70 B	0,6
	44022*	2 x 15	2 x 20	2 x 24,9	T 70 B	0,6
	44023*	2 x 18	2 x 17	2 x 29,9	T 70 B	0,6
	44024*	2 x 24	2 x 12	2 x 39,8	T 70 B	0,6

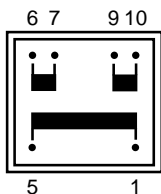
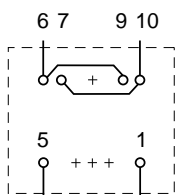
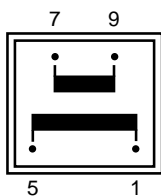

Recommended layout for transformers with 1 secondary winding (Allows the use of a transformer with 2 secondary windings)

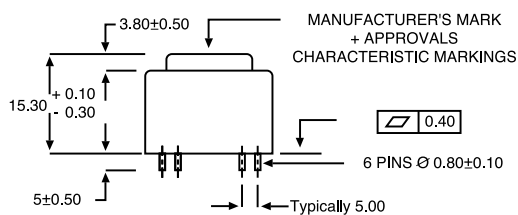
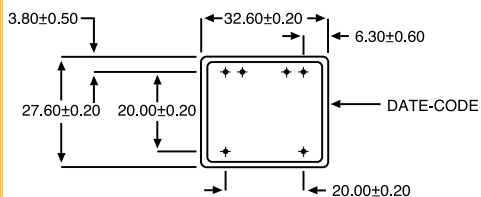

** RECOMMENDED DRILL-HOLE DIAMETER FOR 1,3 mm PINS



PRIMARY VOLTAGE 117 V

Protection	Reference	Secondary voltage V	Secondary current mA	No-load voltage V	Ambient Temperature °C	Rating VA
	44061	6	167	8,6	T 70 B	1
	44062	9	111	12,9	T 70 B	1
	44063	12	83	17,2	T 70 B	1
	44064	15	67	21,6	T 70 B	1
	44065	18	56	25,9	T 70 B	1
	44066	24	42	37,9	T 70 B	1
	44067	2 X 6	2 x 83	2 x 8,6	T 70 B	1
	44068	2 x 9	2 x 56	2 x 12,9	T 70 B	1
	44069	2 x 12	2 x 42	2 x 19	T 70 B	1
	44070	2 x 15	2 x 33	2 x 23,6	T 70 B	1
	44071	2 x 18	2 x 28	2 x 24,9	T 70 B	1
44072	2 x 24	2 x 21	2 x 37,9	T 70 B	1	

EN 61558-2-6

- Vacuum filling
- Two compartments bobbins
- Self-extinguishing plastics UL 94 V0
- Degree of protection IP 00
- 70 grams weight
- Resin class B CEI 85 (20 000 h testing to CEI 126)
- Inherently short-circuits proof
- 30 V and 36 V models are VDE EN 61558-2-6 certified (production on request)

	44338	6	250	10,1	ta 70/B	1,5
	44339	9	167	15,3	ta 70/B	1,5
	44340	12	125	20,2	ta 70/B	1,5
	44341	15	100	25,3	ta 70/B	1,5
	44342	18	83	31,2	ta 70/B	1,5
	44343	24	63	43,3	ta 70/B	1,5
	44344	2 x 6	125	2 x 10,1	ta 70/B	1,5
	44345	2 x 9	83	2 x 15,3	ta 70/B	1,5
	44346	2 x 12	63	2 x 20,2	ta 70/B	1,5
	44347	2 x 15	50	2 x 25,0	ta 70/B	1,5
	44348*	2 x 18	42	2 x 31	ta 70/B	1,5
44349*	2 x 24	31	2 x 43	ta 70/B	1,5	

	44840	6	300	10,1	ta 70/B	1,8
	44841	9	200	15,2	ta 70/B	1,8
	44842	12	150	20,3	ta 70/B	1,8
	44843	15	120	27,3	ta 70/B	1,8
	44844	18	100	30,4	ta 70/B	1,8
	44845	24	75	40,6	ta 70/B	1,8
	44846	2 x 6	2 x 150	2 x 10,1	ta 70/B	1,8
	44847	2 x 9	2 x 100	2 x 15,2	ta 70/B	1,8
	44848	2 x 12	2 x 75	2 x 20,3	ta 70/B	1,8
	44849	2 x 15	2 x 60	2 x 27,3	ta 70/B	1,8

1 Secondary winding

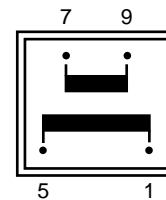

Primary winding

2 Secondary windings

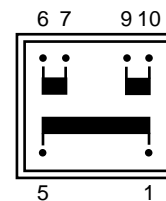

Primary winding

Recommended layout for transformers with 1 secondary winding

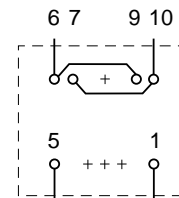

(Allows the use of a transformer with 2 secondary windings)



EN 60950 UL 5085 

- Insulation voltage 4 KV
- 100 % tested production
- Certification : CCA procedure on request

*To be noted 2 x 15 V and 2 x 24 V models are non-approved.

Those transformers meet all requirement of EN 61558-2-4

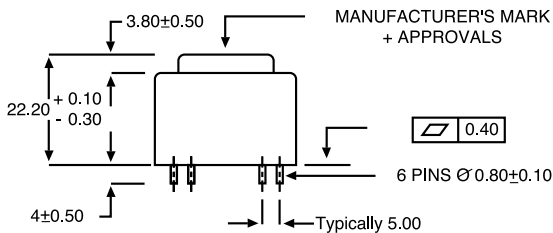
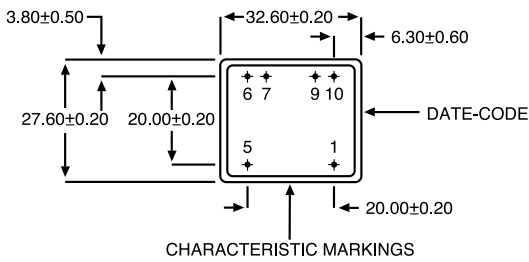



** RECOMMENDED DRILL-HOLE DIAMETER FOR 1,3 mm PINS

PRIMARY VOLTAGE 230 V

Protection	Reference	Secondary voltage V	Secondary current mA	No-load voltage V	Ambient Temperature °C	Rating VA
	44049*	6	167	8,6	T 70 B	1
	44050*	9	111	12,9	T 70 B	1
	44051*	12	83	17,2	T 70 B	1
	44052*	15	67	21,6	T 70 B	1
	44053*	18	56	25,9	T 70 B	1
	44054*	24	42	37,9	T 70 B	1
	44055*	2 x 6	2 x 83	2 x 8,6	T 70 B	1
	44056*	2 x 9	2 x 56	2 x 12,9	T 70 B	1
	44057*	2 x 12	2 x 42	2 x 19	T 70 B	1
	44058*	2 x 15	2 x 33	2 x 23,6	T 70 B	1
	44059*	2 x 18	2 x 28	2 x 24,9	T 70 B	1
	44060**	2 x 24	2 x 21	2 x 37,9	T 70 B	1

* Items usually available on stock

	44326	6	250	10,1	ta 70/B	1,5
	44327	9	167	15,3	ta 70/B	1,5
	44328	12	125	20,2	ta 70/B	1,5
	44329	15	100	25,3	ta 70/B	1,5
	44330	18	83	31,2	ta 70/B	1,5
	44331	24	63	43,3	ta 70/B	1,5
	44332	2 x 6	125	2 x 10,1	ta 70/B	1,5
	44333	2 x 9	83	2 x 15,3	ta 70/B	1,5
	44334	2 x 12	63	2 x 20,2	ta 70/B	1,5
	44335	2 x 15	50	2 x 25,0	ta 70/B	1,5
	44336*	2 x 18	42	2 x 31	ta 70/B	1,5
	44337*	2 x 24	31	2 x 43	ta 70/B	1,5

	44830	6	300	10,1	ta 70/B	1,8
	44831	9	200	15,2	ta 70/B	1,8
	44832	12	150	20,3	ta 70/B	1,8
	44833	15	120	27,3	ta 70/B	1,8
	44834	18	100	30,4	ta 70/B	1,8
	44835	24	75	40,6	ta 70/B	1,8
	44836	2 x 6	2 x 150	2 x 10,1	ta 70/B	1,8
	44837	2 x 9	2 x 100	2 x 15,2	ta 70/B	1,8
	44838	2 x 12	2 x 75	2 x 20,3	ta 70/B	1,8
	44839*	2 x 15	2 x 60	2 x 27,3	ta 70/B	1,8



PRIMARY VOLTAGE 117 V

Protection	Reference	Secondary voltage V	Secondary current mA	No-load voltage V	Ambient Temperature °C	Rating VA
	44097	6	250	9,7	T 70 B	1,5
	44098	9	167	14,5	T 70 B	1,5
	44099	12	125	19,3	T 70 B	1,5
	44100	15	100	24,2	T 70 B	1,5
	44101	18	83	29,8	T 70 B	1,5
	44102	24	63	38,6	T 70 B	1,5
	44103	2 X 6	2 x 125	2 x 9,7	T 70 B	1,5
	44104	2 x 9	2 x 83	2 x 15	T 70 B	1,5
	44105	2 x 12	2 x 63	2 x 19,3	T 70 B	1,5
	44106	2 x 15	2 x 50	2 x 24,2	T 70 B	1,5
	44107	2 x 18	2 x 42	2 x 29	T 70 B	1,5
44108	2 x 24	2 x 31	2 x 38,6	T 70 B	1,5	

	44726	6	283	9,8	T 50 B	1,7
	44727	9	189	14,8	T 50 B	1,7
	44728	12	142	19,7	T 50 B	1,7
	44729	15	113	24,6	T 50 B	1,7
	44730	18	94	30,3	T 50 B	1,7
	44731	24	71	39,3	T 50 B	1,7
	44732	2 x 6	2 x 142	2 x 9,8	T 50 B	1,7
	44733	2 x 9	2 x 94	2 x 15,2	T 50 B	1,7
	44734	2 x 12	2 x 71	2 x 19,7	T 50 B	1,7
	44735	2 x 15	2 x 57	2 x 24,6	T 50 B	1,7
	44736	2 x 18	2 x 47	2 x 29,5	T 50 B	1,7
	44737	2 x 24	2 x 35	2 x 39,3	T 50 B	1,7

	44738	6	300	9,8	T 40 B	1,8
	44739	9	200	14,8	T 40 B	1,8
	44740	12	150	19,7	T 40 B	1,8
	44741	15	120	24,6	T 40 B	1,8
	44742	18	100	30,3	T 40 B	1,8
	44743	24	75	39,3	T 40 B	1,8
	44744	2 x 6	2 x 150	2 x 9,8	T 40 B	1,8
	44745	2 x 9	2 x 100	2 x 15,2	T 40 B	1,8
	44746	2 x 12	2 x 75	2 x 19,7	T 40 B	1,8
	44747	2 x 15	2 x 60	2 x 24,6	T 40 B	1,8
	44748	2 x 18	2 x 50	2 x 29,5	T 40 B	1,8
	44749	2 x 24	2 x 38	2 x 39,3	T 40 B	1,8



- Vacuum filling
- Two compartments bobbins
- Self-extinguishing plastics UL 94 V0
- Degree of protection IP 00
- 80 grams weight
- Resin class B CEI 85 (20 000 h testing to CEI 126)
- Inherently short-circuits proof
- 30 V model is VDE EN 61558-2-6 certified (production on request)

1 Secondary winding

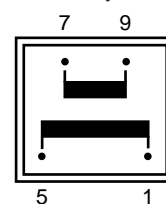

Primary winding

2 Secondary windings

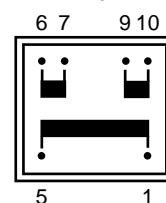

Primary winding

Recommended layout for transformers with 1 secondary winding

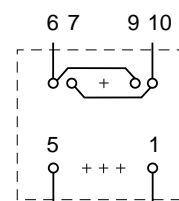

(Allows the use of a transformer with 2 secondary windings)

QUALITY IN SERIES



EN 60950 UL 5085 

- Insulation voltage 4 KV
- 100 % tested production
- Certification : CCA procedure on request

*To be noted : 2 x 18 V and 2 x 24 V models are non-approved.
Those transformers meet all requirement of EN 61558-2-4

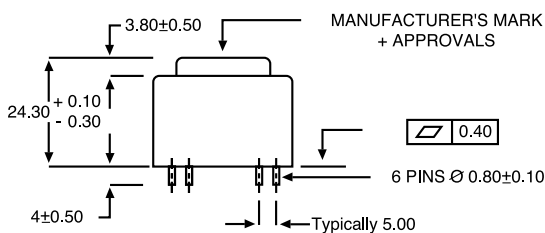
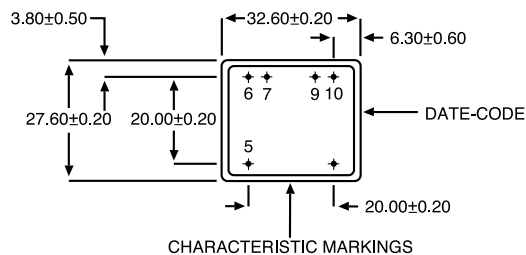



** RECOMMENDED DRILL-HOLE DIAMETER FOR 1,3 mm PINS

PRIMARY VOLTAGE 230 V

Protection	Reference	Secondary voltage V	Secondary current mA	No-load voltage V	Ambient Temperature °C	Rating VA
	44085*	6	250	9,7	T 70 B	1,5
	44086*	9	167	14,5	T 70 B	1,5
	44087*	12	125	19,3	T 70 B	1,5
	44088*	15	100	24,2	T 70 B	1,5
	44089*	18	83	29,8	T 70 B	1,5
	44090*	24	63	38,6	T 70 B	1,5
	44091*	2 X 6	2 x 125	2 x 9,7	T 70 B	1,5
	44092*	2 x 9	2 x 83	2 x 15	T 70 B	1,5
	44093*	2 x 12	2 x 63	2 x 19,3	T 70 B	1,5
	44094*	2 x 15	2 x 50	2 x 24,2	T 70 B	1,5
	44095**	2 x 18	2 x 42	2 x 29	T 70 B	1,5
	44096**	2 x 24	2 x 31	2 x 38,6	T 70 B	1,5

* Items usually available on stock

	44647	6	283	9,8	T 50 B	1,7
	44648	9	189	14,8	T 50 B	1,7
	44649	12	142	19,7	T 50 B	1,7
	44650	15	113	24,6	T 50 B	1,7
	44651	18	94	30,3	T 50 B	1,7
	44652	24	71	39,3	T 50 B	1,7
	44653	2 x 6	2 x 142	2 x 9,8	T 50 B	1,7
	44654	2 x 9	2 x 94	2 x 15,2	T 50 B	1,7
	44655	2 x 12	2 x 71	2 x 19,7	T 50 B	1,7
	44656	2 x 15	2 x 57	2 x 24,6	T 50 B	1,7
	44483*	2 x 18	2 x 47	2 x 29,5	T 50 B	1,7
	44484*	2 x 24	2 x 35	2 x 39,3	T 50 B	1,7

	44657	6	300	9,8	T 40 B	1,8
	44658	9	200	14,8	T 40 B	1,8
	44659	12	150	19,7	T 40 B	1,8
	44660	15	120	24,6	T 40 B	1,8
	44661	18	100	30,3	T 40 B	1,8
	44662	24	75	39,3	T 40 B	1,8
	44663	2 x 6	2 x 150	2 x 9,8	T 40 B	1,8
	44664	2 x 9	2 x 100	2 x 15,2	T 40 B	1,8
	44665	2 x 12	2 x 75	2 x 19,7	T 40 B	1,8
	44666	2 x 15	2 x 60	2 x 24,6	T 40 B	1,8
	44485*	2 x 18	2 x 50	2 x 29,5	T 40 B	1,8
	44486*	2 x 24	2 x 38	2 x 39,3	T 40 B	1,8



PRIMARY VOLTAGE 117 V

Protection	Reference	Secondary voltage V	Secondary current mA	No-load voltage V	Ambient Temperature °C	Rating VA
	44133	6	333	10,4	T 70 B	2
	44134	9	222	15,5	T 70 B	2
	44135	12	167	20,7	T 70 B	2
	44136	15	133	25,8	T 70 B	2
	44137	18	111	30,8	T 70 B	2
	44138	24	83	41,4	T 70 B	2
	44139	2 X 6	2 x 167	2 x 10,4	T 70 B	2
	44140	2 x 9	2 x 111	2 x 15,4	T 70 B	2
	44141	2 x 12	2 x 83	2 x 20,7	T 70 B	2
	44142	2 x 15	2 x 67	2 x 25,8	T 70 B	2
	44143	2 x 18	2 x 56	2 x 30,8	T 70 B	2
	44144	2 x 24	2 x 42	2 x 41,4	T 70 B	2



- Vacuum filling
- Two compartments bobbins
- Self-extinguishing plastics UL 94 VO
- Degree of protection IP 00
- 100 grams weight
- Resin class B CEI 85 (20 000 h testing to CEI 126)
- Inherently short-circuits proof
- 30 V model is VDE EN 61558-2-6 certified (production on request)
- Insulation voltage 4 KV

	44750	6	383	10,5	T 50 B	2,3
	44751	9	256	15,5	T 50 B	2,3
	44752	12	192	21	T 50 B	2,3
	44753	15	153	25,3	T 50 B	2,3
	44754	18	128	31	T 50 B	2,3
	44755	24	96	42	T 50 B	2,3
	44756	2 x 6	2 x 192	2 x 10,5	T 50 B	2,3
	44757	2 x 9	2 x 128	2 x 15,5	T 50 B	2,3
	44758	2 x 12	2 x 96	2 x 21	T 50 B	2,3
	44759	2 x 15	2 x 77	2 x 24,5	T 50 B	2,3
	44760	2 x 18	2 x 64	2 x 31	T 50 B	2,3
	44761	2 x 24	2 x 48	2 x 42	T 50 B	2,3

	44762	6	400	10,5	T 40 B	2,4
	44763	9	267	15,5	T 40 B	2,4
	44764	12	200	21	T 40 B	2,4
	44765	15	160	25,3	T 40 B	2,4
	44766	18	133	31	T 40 B	2,4
	44767	24	100	42	T 40 B	2,4
	44768	2 x 6	2 x 200	2 x 10,5	T 40 B	2,4
	44769	2 x 9	2 x 133	2 x 15,5	T 40 B	2,4
	44770	2 x 12	2 x 100	2 x 21	T 40 B	2,4
	44771	2 x 15	2 x 80	2 x 24,5	T 40 B	2,4
	44772	2 x 18	2 x 67	2 x 31	T 40 B	2,4
	44773	2 x 24	2 x 50	2 x 42	T 40 B	2,4

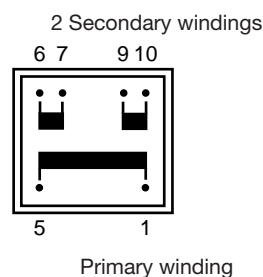
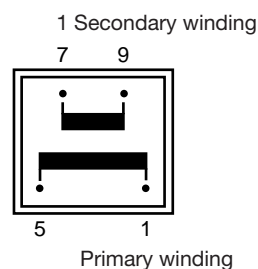

Recommended layout for transformers with 1 secondary winding

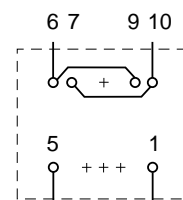

(Allows the use of a transformer with 2 secondary windings)



EN 60950 UL 5085

- 100 % tested production
- Certification : CCA procedure on request

*To be noted : 2 x 18 V and 2 x 24 V models are non-approved.
Those transformers meet all requirement of EN 61558-2-4

PRIMARY VOLTAGE 230 V

Protection	Reference	Secondary voltage V	Secondary current mA	No-load voltage V	Ambient Temperature °C	Rating VA
	44121*	6	333	10,4	T 70 B	2
	44122*	9	222	15,5	T 70 B	2
	44123*	12	167	20,7	T 70 B	2
	44124*	15	133	25,8	T 70 B	2
	44125*	18	111	30,8	T 70 B	2
	44126*	24	83	41,4	T 70 B	2
	44127*	2 X 6	2 x 167	2 x 10,4	T 70 B	2
	44128*	2 x 9	2 x 111	2 x 15,4	T 70 B	2
	44129*	2 x 12	2 x 83	2 x 20,7	T 70 B	2
	44130*	2 x 15	2 x 67	2 x 25,8	T 70 B	2
	44131**	2 x 18	2 x 56	2 x 30,8	T 70 B	2
	44132**	2 x 24	2 x 42	2 x 41,4	T 70 B	2

*Items usually available on stock

	44667	6	383	10,5	T 50 B	2,3
	44668	9	256	15,5	T 50 B	2,3
	44669	12	192	21	T 50 B	2,3
	44670	15	153	25,3	T 50 B	2,3
	44671	18	128	31	T 50 B	2,3
	44672	24	96	42	T 50 B	2,3
	44673	2 x 6	2 x 192	2 x 10,5	T 50 B	2,3
	44674	2 x 9	2 x 128	2 x 15,5	T 50 B	2,3
	44675	2 x 12	2 x 96	2 x 21	T 50 B	2,3
	44676	2 x 15	2 x 77	2 x 24,5	T 50 B	2,3
	44487*	2 x 18	2 x 64	2 x 31	T 50 B	2,3
	44488*	2 x 24	2 x 48	2 x 42	T 50 B	2,3

	44677	6	400	10,5	T 40 B	2,4
	44678	9	267	15,5	T 40 B	2,4
	44679	12	200	21	T 40 B	2,4
	44680	15	160	25,3	T 40 B	2,4
	44681	18	133	31	T 40 B	2,4
	44682	24	100	42	T 40 B	2,4
	44683	2 x 6	2 x 200	2 x 10,5	T 40 B	2,4
	44684	2 x 9	2 x 133	2 x 15,5	T 40 B	2,4
	44685	2 x 12	2 x 100	2 x 21	T 40 B	2,4
	44686	2 x 15	2 x 80	2 x 24,5	T 40 B	2,4
	44489*	2 x 18	2 x 67	2 x 31	T 40 B	2,4
	44490*	2 x 24	2 x 50	2 x 42	T 40 B	2,4

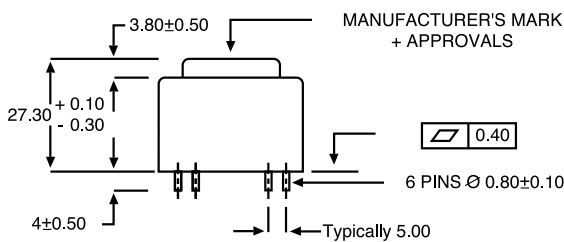
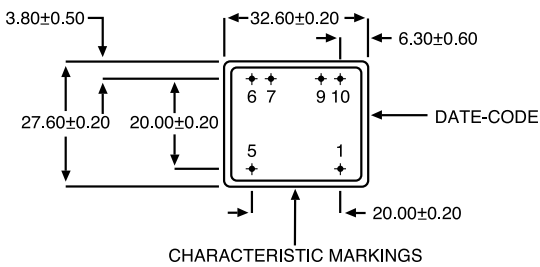

** RECOMMENDED DRILL-HOLE DIAMETER FOR 1.3 mm PINS

ENCAPSULATED TRANSFORMERS
44000 SERIES



PRIMARY VOLTAGE 117 V

Protection	Reference	Secondary voltage V	Secondary current mA	No-load voltage V	Ambient Temperature °C	Rating VA
	44169	6	383	10,5	T 70 B	2,3
	44170	9	256	15,7	T 70 B	2,3
	44171	12	192	21	T 70 B	2,3
	44172	15	153	25,9	T 70 B	2,3
	44173	18	128	31,4	T 70 B	2,3
	44174	24	96	41,9	T 70 B	2,3
	44175	2 X 6	2 x 192	2 x 10,5	T 70 B	2,3
	44176	2 x 9	2 x 128	2 x 15,7	T 70 B	2,3
	44177	2 x 12	2 x 96	2 x 21	T 70 B	2,3
	44178	2 x 15	2 x 77	2 x 25,9	T 70 B	2,3
	44179	2 x 18	2 x 64	2 x 31,4	T 70 B	2,3
	44180	2 x 24	2 x 48	2 x 41,9	T 70 B	2,3

	44774	6	450	10,5	T 50 B	2,7
	44775	9	300	15,4	T 50 B	2,7
	44776	12	225	21,1	T 50 B	2,7
	44777	15	180	26,3	T 50 B	2,7
	44778	18	150	30,9	T 50 B	2,7
	44779	24	113	42	T 50 B	2,7
	44780	2 x 6	2 x 225	2 x 10,5	T 50 B	2,7
	44781	2 x 9	2 x 150	2 x 15,4	T 50 B	2,7
	44782	2 x 12	2 x 113	2 x 21,1	T 50 B	2,7
	44783	2 x 15	2 x 90	2 x 26,3	T 50 B	2,7
	44784	2 x 18	2 x 75	2 x 31,5	T 50 B	2,7
	44785	2 x 24	2 x 56	2 x 42,1	T 50 B	2,7

	44786	6	467	10,5	T 40 B	2,8
	44787	9	311	15,4	T 40 B	2,8
	44788	12	233	21,1	T 40 B	2,8
	44789	15	187	26,3	T 40 B	2,8
	44790	18	156	30,9	T 40 B	2,8
	44791	24	117	42,1	T 40 B	2,8
	44792	2 x 6	2 x 233	2 x 10,5	T 40 B	2,8
	44793	2 x 9	2 x 156	2 x 15,4	T 40 B	2,8
	44794	2 x 12	2 x 117	2 x 21,1	T 40 B	2,8
	44795	2 x 15	2 x 93	2 x 26,3	T 40 B	2,8
	44796	2 x 18	2 x 77	2 x 31,5	T 40 B	2,8
	44797	2 x 24	2 x 58	2 x 42,1	T 40 B	2,8



- Vacuum filling
- Two compartments bobbins
- Self-extinguishing plastics UL 94 VO
- Degree of protection IP 00
- 70 grams weight
- Resin class B CEI 85 (20 000 h testing to CEI 126)
- Inherently short-circuits proof
- 30 V model is VDE EN 61558-2-6 certified (production on request)

1 Secondary winding

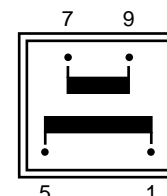

Primary winding

2 Secondary windings

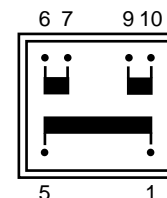

Primary winding

Recommended layout for transformers with 1 secondary winding

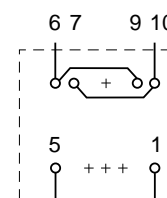

(Allows the use of a transformer with 2 secondary windings)

EN 60950 UL 5085 

- Insulation voltage 4 KV
- 100 % tested production
- Certification : CCA procedure on request

*To be noted : 2 x 18 V and 2 x 24 V models are non-approved.
Those transformers meet all requirement of EN 61558-2-4

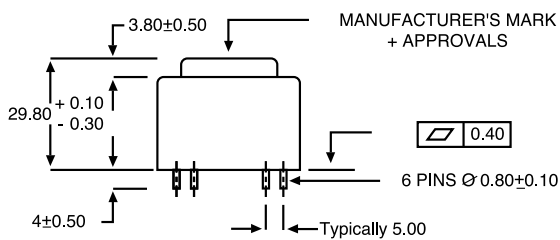
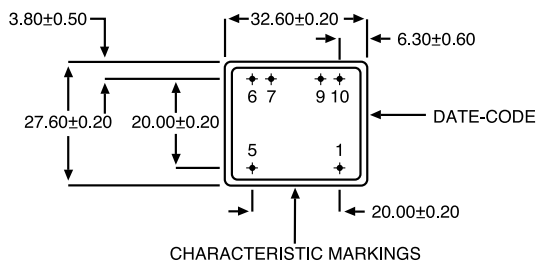



** RECOMMENDED DRILL-HOLE DIAMETER FOR 1.3 mm PINS

PRIMARY VOLTAGE 230 V

Protection	Reference	Secondary voltage V	Secondary current mA	No-load voltage V	Ambient Temperature °C	Rating VA
	44157*	6	383	10,5	T 70 B	2,3
	44158*	9	256	15,7	T 70 B	2,3
	44159*	12	192	21	T 70 B	2,3
	44160*	15	153	25,9	T 70 B	2,3
	44161*	18	128	31,4	T 70 B	2,3
	44162*	24	96	41,9	T 70 B	2,3
	44163*	2 X 6	2 x 192	2 x 10,5	T 70 B	2,3
	44164*	2 x 9	2 x 128	2 x 15,7	T 70 B	2,3
	44165*	2 x 12	2 x 96	2 x 21	T 70 B	2,3
	44166*	2 x 15	2 x 77	2 x 25,9	T 70 B	2,3
	44167**	2 x 18	2 x 64	2 x 31,4	T 70 B	2,3
	44168**	2 x 24	2 x 48	2 x 41,9	T 70 B	2,3

*Items usually available on stock

	44687	6	450	10,5	T 50 B	2,7
	44688	9	300	15,4	T 50 B	2,7
	44689	12	225	21,1	T 50 B	2,7
	44690	15	180	26,3	T 50 B	2,7
	44691	18	150	30,9	T 50 B	2,7
	44692	24	113	42	T 50 B	2,7
	44693	2 x 6	2 x 225	2 x 10,5	T 50 B	2,7
	44694	2 x 9	2 x 150	2 x 15,4	T 50 B	2,7
	44695	2 x 12	2 x 113	2 x 21,1	T 50 B	2,7
	44696	2 x 15	2 x 90	2 x 26,3	T 50 B	2,7
	44491*	2 x 18	2 x 75	2 x 31,5	T 50 B	2,7
	44492*	2 x 24	2 x 56	2 x 42,1	T 50 B	2,7

	44697	6	467	10,5	T 40 B	2,8
	44698	9	311	15,4	T 40 B	2,8
	44699	12	233	21,1	T 40 B	2,8
	44700	15	187	26,3	T 40 B	2,8
	44701	18	156	30,9	T 40 B	2,8
	44702	24	117	42,1	T 40 B	2,8
	44703	2 x 6	2 x 233	2 x 10,5	T 40 B	2,8
	44704	2 x 9	2 x 156	2 x 15,4	T 40 B	2,8
	44705	2 x 12	2 x 117	2 x 21,1	T 40 B	2,8
	44706	2 x 15	2 x 93	2 x 26,3	T 40 B	2,8
	44493*	2 x 18	2 x 70	2 x 31,5	T 40 B	2,8
	44494*	2 x 24	2 x 58	2 x 42,1	T 40 B	2,8

**PRIMARY VOLTAGE
117 V**

Secondary protection mA	Reference	Secondary voltage V	Secondary current mA	No-load voltage V	Ambient Temperature °C	Rating VA
630	44205	6	533	8	T 70 B	3,2
400	44206	9	356	12	T 70 B	3,2
315	44207	12	267	16	T 70 B	3,2
250	44208	15	213	20	T 70 B	3,2
200	44209	18	178	24,1	T 70 B	3,2
160	44210	24	133	32,1	T 70 B	3,2
315	44211	2 x 6	2 x 267	2 x 8	T 70 B	3,2
200	44212	2 x 9	2 x 178	2 x 12	T 70 B	3,2
160	44213	2 x 12	2 x 133	2 x 16	T 70 B	3,2
125	44214	2 x 15	2 x 107	2 x 20	T 70 B	3,2
100	44215	2 x 18	2 x 89	2 x 24	T 70 B	3,2
80	44216	2 x 24	2 x 67	2 x 32,1	T 70 B	3,2



EN 61558-2-6

- Vacuum filling
- Two compartments bobbins
- Self-extinguishing plastics UL 94 V0
- Degree of protection IP 00
- 150 grams weight
- Resin class B CEI 85 (20 000 h testing to CEI 126)
- Fuse protection on secondary side (see diagram) to be assumed by customer

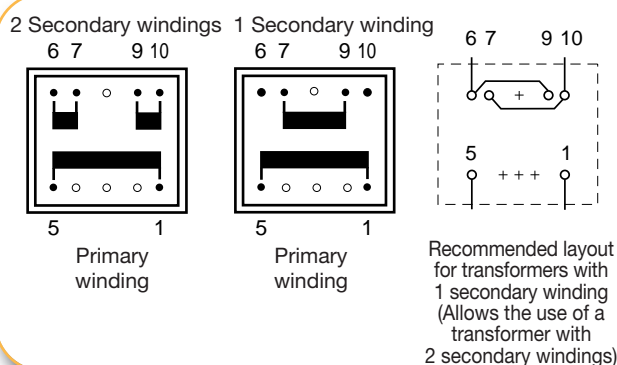
**PRIMARY VOLTAGE
117 V**

Secondary protection mA	Reference	Secondary voltage V	Secondary current mA	No-load voltage V	Ambient Temperature °C	Rating VA
800	44241	6	833	8,4	T 50 B	5
630	44242	9	556	12,6	T 50 B	5
400	44243	12	417	16,9	T 50 B	5
315	44244	15	333	21	T 50 B	5
315	44245	18	278	25,3	T 50 B	5
200	44246	24	208	33,7	T 50 B	5
400	44247	2 x 6	2 x 417	2 x 8,4	T 50 B	5
315	44248	2 x 9	2 x 278	2 x 12,6	T 50 B	5
200	44249	2 x 12	2 x 208	2 x 16,9	T 50 B	5
160	44250	2 x 15	2 x 167	2 x 21	T 50 B	5
160	44251	2 x 18	2 x 139	2 x 25,3	T 50 B	5
100	44252	2 x 24	2 x 104	2 x 33,7	T 50 B	5



EN 61558-2-6

- Vacuum filling
- Two compartments bobbins
- Self-extinguishing plastics UL 94 V0
- Degree of protection IP 00
- 200 grams weight
- Resin class B CEI 85 (20 000 h testing to CEI 126)
- Fuse protection on secondary side (see diagram) to be assumed by customer

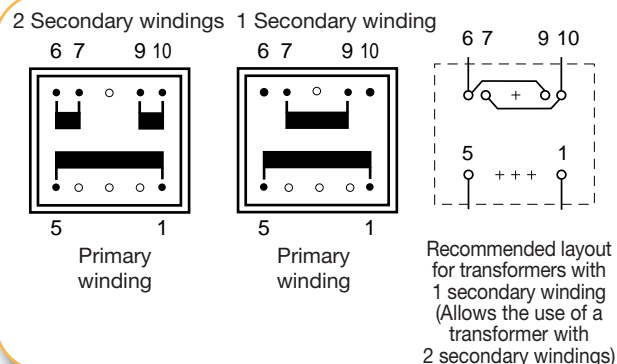

3,2 VA

EI 38-13,6

SERIE 44000

EN 60950 UL 5085 

- 30 V and 36 V models are VDE EN 61558-2-6 certified (production on request)
- Insulation voltage 4 KV
- 100 % tested production
- Certification : CCA procedure on request

*To be noted : 2 x 24 V model is non-approved.
Those transformers meet all requirement of EN 61558-2-4

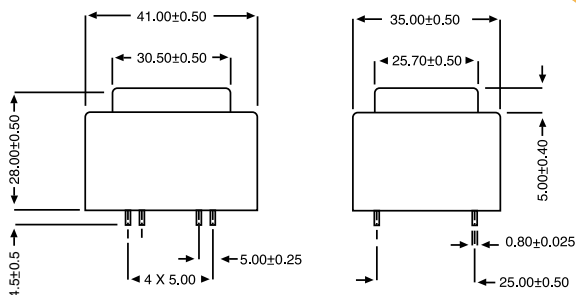

** RECOMMENDED DRILL-HOLE DIAMETER FOR 1,3 mm PINS

PRIMARY VOLTAGE 230 V

Secondary protection mA	Reference	Secondary voltage V	Secondary current mA	No-load voltage V	Ambient Temperature °C	Rating VA
630	44193	6	533	8	T 70 B	3,2
400	44194	9	356	12	T 70 B	3,2
315	44195	12	267	16	T 70 B	3,2
250	44196	15	213	20	T 70 B	3,2
200	44197	18	178	24,1	T 70 B	3,2
160	44198	24	133	32,1	T 70 B	3,2
315	44199	2 x 6	2 x 267	2 x 8	T 70 B	3,2
200	44200	2 x 9	2 x 178	2 x 12	T 70 B	3,2
160	44201	2 x 12	2 x 133	2 x 16	T 70 B	3,2
125	44202	2 x 15	2 x 107	2 x 20	T 70 B	3,2
100	44203	2 x 18	2 x 89	2 x 24	T 70 B	3,2
80	44204*	2 x 24	2 x 67	2 x 32,1	T 70 B	3,2

5 VA

EI 42-14,8

SERIE 44000

EN 60950 UL 5085 

- 30 V and 36 V models are VDE EN 61558-2-6 certified (production on request)
- Insulation voltage 4 KV
- 100 % tested production
- Certification : CCA procedure on request

*To be noted : 2 x 24 V model is non-approved.
Those transformers meet all requirement of EN 61558-2-4

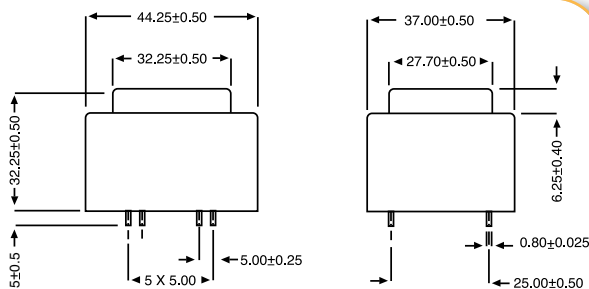

** RECOMMENDED DRILL-HOLE DIAMETER FOR 1,3 mm PINS

PRIMARY VOLTAGE 230 V

Secondary protection mA	Reference	Secondary voltage V	Secondary current mA	No-load voltage V	Ambient Temperature °C	Rating VA
800	44229	6	833	8,4	T 50 B	5
630	44230	9	556	12,6	T 50 B	5
400	44231	12	417	16,9	T 50 B	5
315	44232	15	333	21	T 50 B	5
315	44233	18	278	25,3	T 50 B	5
200	44234	24	208	33,7	T 50 B	5
400	44235	2 x 6	2 x 417	2 x 8,4	T 50 B	5
315	44236	2 x 9	2 x 278	2 x 12,6	T 50 B	5
200	44237	2 x 12	2 x 208	2 x 16,9	T 50 B	5
160	44238	2 x 15	2 x 167	2 x 21	T 50 B	5
160	44239	2 x 18	2 x 139	2 x 25,3	T 50 B	5
100	44240*	2 x 24	2 x 104	2 x 33,7	T 50 B	5

ENCAPSULATED TRANSFORMERS
44000 SERIES



PRIMARY VOLTAGE 117 V

Primary protection mA	Reference	Secondary voltage V	Secondary current mA	No-load voltage V	Ambient Temperature °C	Rating VA
125	44277	6	1667	7,2	T 50 B	10
125	44278	9	1111	10,8	T 50 B	10
125	44279	12	833	14,4	T 50 B	10
125	44280	15	667	18,1	T 50 B	10
125	44281	18	556	21,6	T 50 B	10
125	44282	24	417	28,9	T 50 B	10
125	44283	2 x 6	2 x 833	2 x 7,2	T 50 B	10
125	44284	2 x 9	2 x 556	2 x 10,8	T 50 B	10
125	44285	2 x 12	2 x 417	2 x 14,4	T 50 B	10
125	44286	2 x 15	2 x 333	2 x 18,1	T 50 B	10
125	44287	2 x 18	2 x 278	2 x 21,6	T 50 B	10
125	44288	2 x 24	2 x 208	2 x 28,9	T 50 B	10



EN 61558-2-6

- Vacuum filling
- Two compartments bobbins
- Self-extinguishing plastics UL 94 V0
- Degree of protection IP 00
- 300 grams weight
- Resin class B CEI 85 (20 000 h testing to CEI 126)
- Fuse protection on primary side (see diagram) to be assumed by customer

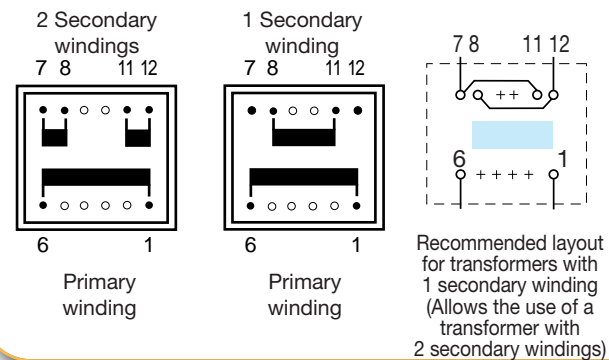

PRIMARY VOLTAGE 117 V

Secondary protection mA	Reference	Secondary voltage V	Secondary current mA	No-load voltage V	Ambient Temperature °C	Rating VA
2,5	44313	6	2667	7,4	T 50 B	16
2,0	44314	9	1778	11,1	T 50 B	16
1,25	44315	12	1333	14,7	T 50 B	16
1	44316	15	1067	18,4	T 50 B	16
1	44317	18	889	22,1	T 50 B	16
0,63	44318	24	667	29,3	T 50 B	16
1,25	44319	2 x 6	2 x 1333	2 x 7,4	T 50 B	16
1	44320	2 x 9	2 x 889	2 x 11,1	T 50 B	16
0,63	44321	2 x 12	2 x 667	2 x 14,7	T 50 B	16
0,5	44322	2 x 15	2 x 533	2 x 18,4	T 50 B	16
0,5	44323	2 x 18	2 x 444	2 x 22	T 50 B	16
0,315	44324	2 x 24	2 x 333	2 x 29,3	T 50 B	16



EN 61558-2-6

- Vacuum filling
- Two compartments bobbins
- Self-extinguishing plastics UL 94 V0
- Degree of protection IP 00
- 400 grams weight
- Resin class B CEI 85 (20 000 h testing to CEI 126)
- Fuse protection on secondary side (see diagram) to be assumed by customer

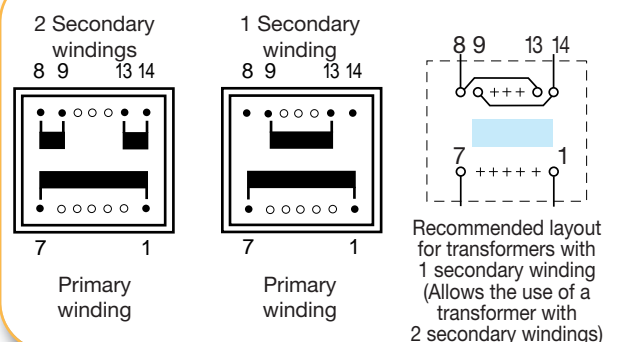



EN 60950 UL 5085

- 30 V and 36 V models are VDE EN 61558-2-6 certified (production on request)
- Insulation voltage 4 KV
- 100 % tested production
- Certification : CCA procedure on request

*To be noted : 2 x 24 V model is non-approved.
Those transformers meet all requirement of EN 61558-2-4

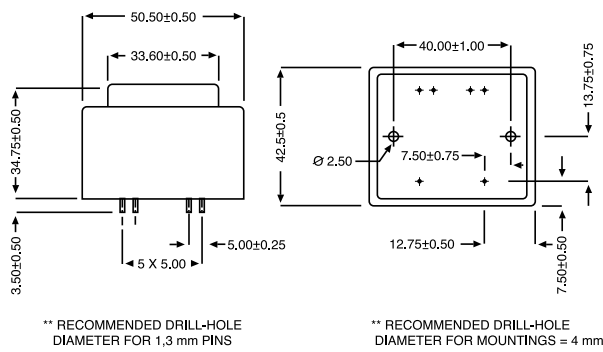

PRIMARY VOLTAGE 230 V

Primary protection mA	Reference	Secondary voltage V	Secondary current mA	No-load voltage V	Ambient Temperature °C	Rating VA
63	44265	6	1667	7,2	T 50 B	10
63	44266	9	1111	10,8	T 50 B	10
63	44267	12	833	14,4	T 50 B	10
63	44268	15	667	18,1	T 50 B	10
63	44269	18	556	21,6	T 50 B	10
63	44270	24	417	28,9	T 50 B	10
63	44271	2 x 6	2 x 833	2 x 7,2	T 50 B	10
63	44272	2 x 9	2 x 556	2 x 10,8	T 50 B	10
63	44273	2 x 12	2 x 417	2 x 14,4	T 50 B	10
63	44274	2 x 15	2 x 333	2 x 18,1	T 50 B	10
63	44275	2 x 18	2 x 278	2 x 21,6	T 50 B	10
63	44276*	2 x 24	2 x 208	2 x 28,9	T 50 B	10



EN 60950 UL 5085

- 30 V and 36 V models are VDE EN 61558-2-6 certified (production on request)
- Insulation voltage 4 KV
- 100 % tested production
- Certification : CCA procedure on request

*To be noted : 2 x 24 V model is non-approved.
Those transformers meet all requirement of EN 61558-2-4

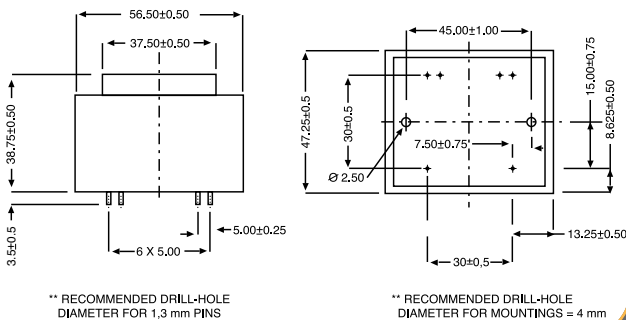

PRIMARY VOLTAGE 230 V

Secondary protection mA	Reference	Secondary voltage V	Secondary current mA	No-load voltage V	Ambient Temperature °C	Rating VA
2,500	44301	6	2667	7,4	T 50 B	16
2,000	44302	9	1778	11,1	T 50 B	16
1,25	44303	12	1333	14,7	T 50 B	16
1	44304	15	1067	18,4	T 50 B	16
1	44305	18	889	22,1	T 50 B	16
0,63	44306	24	667	29,3	T 50 B	16
1,25	44307	2 x 6	2 x 1333	2 x 7,4	T 50 B	16
1	44308	2 x 9	2 x 889	2 x 11,1	T 50 B	16
0,63	44309	2 x 12	2 x 667	2 x 14,7	T 50 B	16
0,5	44310	2 x 15	2 x 533	2 x 18,4	T 50 B	16
0,5	44311	2 x 18	2 x 444	2 x 22	T 50 B	16
0,315	44312*	2 x 24	2 x 333	2 x 29,3	T 50 B	16

ENCAPSULATED TRANSFORMERS
44000 SERIES



PRIMARY VOLTAGE 117 V

Primary protection mA	Reference	Secondary voltage V	Secondary current mA	No-load voltage V	Ambient Temperature °C	Rating VA
250	44444	6	3667	6,8	T 50 B	22
250	44445	9	2444	10,3	T 50 B	22
250	44446	12	1833	13,7	T 50 B	22
250	44447	15	1467	17,1	T 50 B	22
250	44448	18	1222	20,5	T 50 B	22
250	44449	24	917	27,3	T 50 B	22
250	44450	2 x 6	2 x 1833	2 x 6,8	T 50 B	22
250	44451	2 x 9	2 x 1222	2 x 10,3	T 50 B	22
250	44452	2 x 12	2 x 917	2 x 13,7	T 50 B	22
250	44453	2 x 15	2 x 733	2 x 17,1	T 50 B	22
250	44454	2 x 18	2 x 611	2 x 20,5	T 50 B	22
250	44455	2 x 24	2 x 458	2 x 27,3	T 50 B	22



EN 61558-2-6

- Vacuum filling
- Two compartments bobbins
- Self-extinguishing plastics UL 94 V0
- Degree of protection IP 00
- 550 grams weight
- Resin class B CEI 85 (20 000 h testing to CEI 126)
- Fuse protection on primary side (see diagram) to be assumed by customer

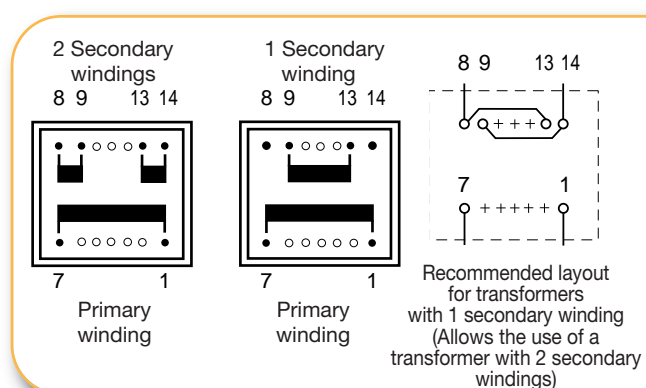

PRIMARY VOLTAGE 117 V

Primary protection mA	Reference	Secondary voltage V	Secondary current mA	No-load voltage V	Ambient Temperature °C	Rating VA
315	44385	6	5000	6,9	T 50 B	30
315	44386	9	3333	10,3	T 50 B	30
315	44387	12	2500	13,8	T 50 B	30
315	44388	15	2000	17,2	T 50 B	30
315	44389	18	1667	20,8	T 50 B	30
315	44390	24	1250	27,7	T 50 B	30
315	44391	2 x 6	2 x 2500	2 x 6,9	T 50 B	30
315	44392	2 x 9	2 x 1667	2 x 10,3	T 50 B	30
315	44393	2 x 12	2 x 1250	2 x 13,8	T 50 B	30
315	44394	2 x 15	2 x 1000	2 x 17,2	T 50 B	30
315	44395	2 x 18	2 x 833	2 x 20,8	T 50 B	30
315	44396	2 x 24	2 x 625	2 x 27,7	T 50 B	30



EN 61558-2-6

- Vacuum filling
- Two compartments bobbins
- Self-extinguishing plastics UL 94 V0
- Degree of protection IP 00
- 700 grams weight
- Resin class B CEI 85 (20 000 h testing to CEI 126)
- Fuse protection on primary side (see diagram) to be assumed by customer

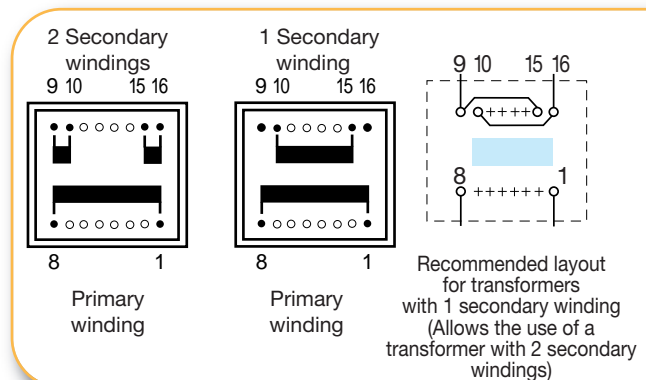



EN 60950 UL 5085

- 30 V and 36 V models are VDE EN 61558-2-6 certified (production on request)
- Insulation voltage 4 KV
- 100 % tested production
- Certification : CCA procedure on request

*To be noted : 2 x 24 V model is non-approved.
Those transformers meet all requirement of EN 61558-2-4

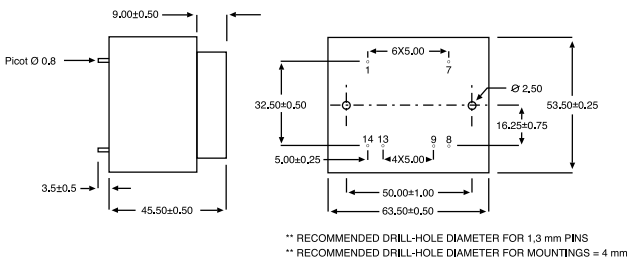

PRIMARY VOLTAGE 230 V

Primary protection mA	Reference	Secondary voltage V	Secondary current mA	No-load voltage V	Ambient Temperature °C	Rating VA
125	44432	6	3667	6,8	T 50 B	22
125	44433	9	2444	10,3	T 50 B	22
125	44434	12	1833	13,7	T 50 B	22
125	44435	15	1467	17,1	T 50 B	22
125	44436	18	1222	20,5	T 50 B	22
125	44437	24	917	27,3	T 50 B	22
125	44438	2 x 6	2 x 1833	2 x 6,8	T 50 B	22
125	44439	2 x 9	2 x 1222	2 x 10,3	T 50 B	22
125	44440	2 x 12	2 x 917	2 x 13,7	T 50 B	22
125	44441	2 x 15	2 x 733	2 x 17,1	T 50 B	22
125	44442	2 x 18	2 x 611	2 x 20,5	T 50 B	22
125	44443*	2 x 24	2 x 458	2 x 27,3	T 50 B	22



EN 60950 UL 5085

- 30 V and 36 V models are VDE EN 61558-2-6 certified (production on request)
- Insulation voltage 4 KV
- 100 % tested production
- Certification : CCA procedure on request

*To be noted : 2 x 24 V model is non-approved.
Those transformers meet all requirement of EN 61558-2-4

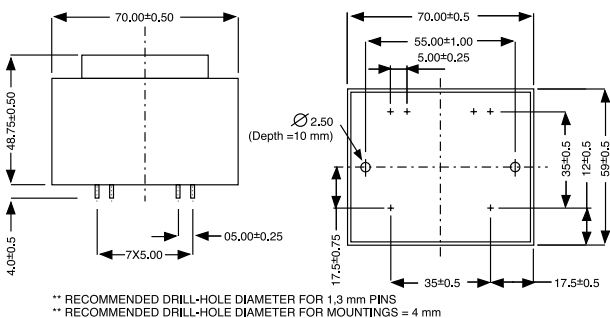

PRIMARY VOLTAGE 230 V

Primary protection mA	Reference	Secondary voltage V	Secondary current mA	No-load voltage V	Ambient Temperature °C	Rating VA
160	44373	6	5000	6,9	T 50 B	30
160	44374	9	3333	10,3	T 50 B	30
160	44375	12	2500	13,8	T 50 B	30
160	44376	15	2000	17,2	T 50 B	30
160	44377	18	1667	20,8	T 50 B	30
160	44378	24	1250	27,7	T 50 B	30
160	44379	2 x 6	2 x 2500	2 x 6,9	T 50 B	30
160	44380	2 x 9	2 x 1667	2 x 10,3	T 50 B	30
160	44381	2 x 12	2 x 1250	2 x 13,8	T 50 B	30
160	44382	2 x 15	2 x 1000	2 x 17,2	T 50 B	30
160	44383	2 x 18	2 x 833	2 x 20,8	T 50 B	30
160	44384*	2 x 24	2 x 625	2 x 27,7	T 50 B	30

ENCAPSULATED TRANSFORMERS

44000 SERIES

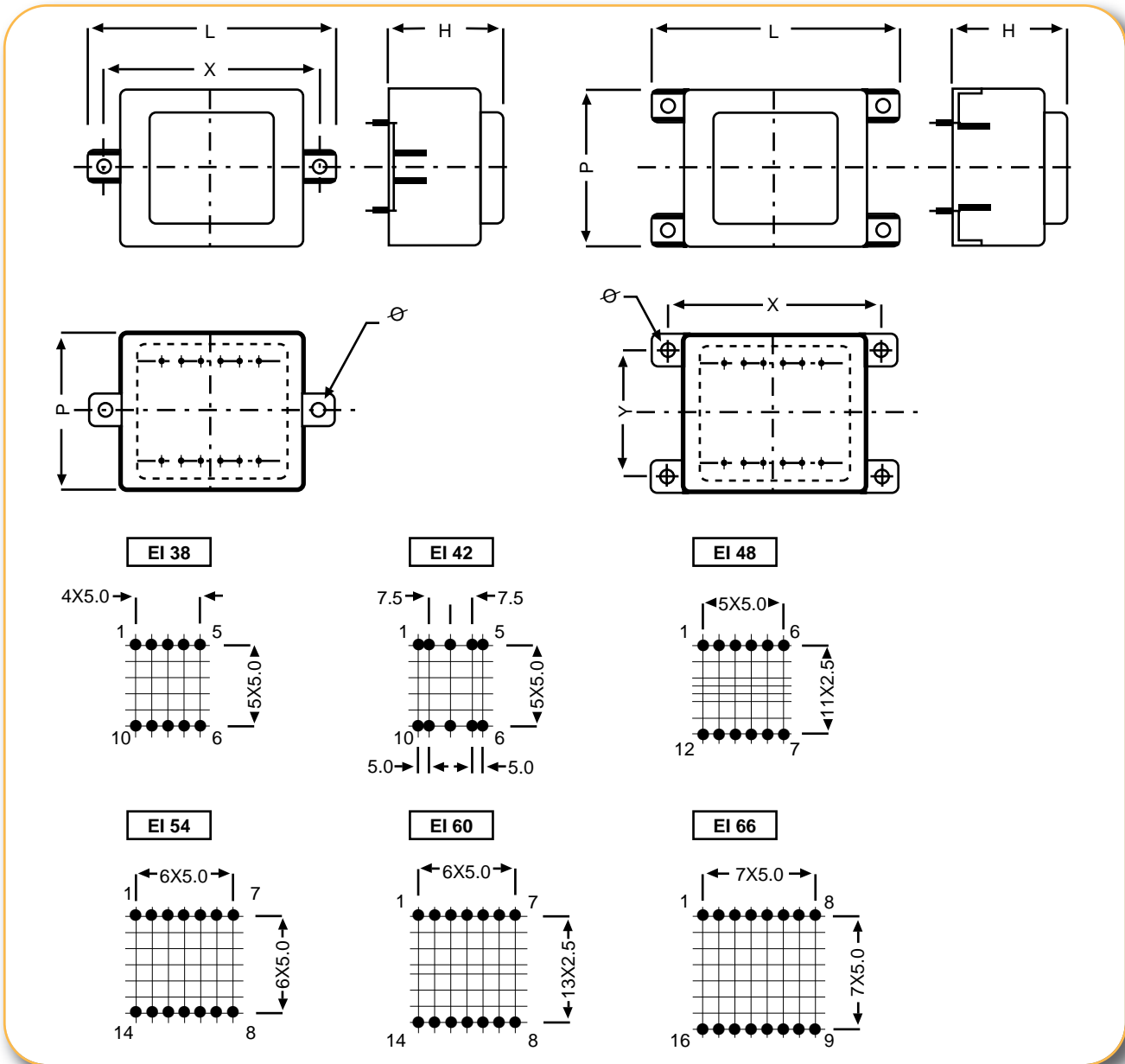

CIRCUIT	L ± 0,50	P ± 0,40	H ± 0,40	X ± 0,50	Y ± 0,50	∅ ± 0,3
EI 38 X 13,6	55,6	34,9	28,1	47,5		3,2
EI 42 X 14,8	64	37	32,3	55,0		4,2
EI 48 X 16,8	69	42,3	34,6	60		4,2
EI 54 X 18,8	74	47,3	38,8	65		4,2
EI 60 X 21	81,5	53,3	44,7	72,5	43,5	4,2
EI 66 X 23	87,2	58,6	48,5	77,5	47,5	4,2

Series 44000 transformers can be equipped with boxes with lugs and also 2,8 «faston» terminal tags while still conforming to the specifications in the standard references.

- For boxes with 2 lugs and pin type output, add suffix 1 to the reference of the standard transformer (example : 44198-1)
- For boxes with 2 lugs and 2,8 «faston» output, add suffix 2 to the reference of the standard transformer (example : 44199-2)
- For boxes with 4 lugs and pin type output, add suffix 3 to the reference of the standard transformer (example : 44200-3)
- For boxes with 4 lugs and 2,8 «faston» output, add suffix 4 to the reference of the standard transformer (example : 44201-4)

These models are not available on stock.

- 1 VA** • 230 V supply voltage by series/parallel connection
- Vacuum filling
- One compartment housing **1 VA**
- Two compartments bobbins 0,8 VA
- Degree of protection IP 00
- 50 grams weight

- Resin UL 94 V0
- Design protection against short-circuits
- Insulation voltage 4 KV
- 100 % tested production

Conform to EN 61558 - UL 5085

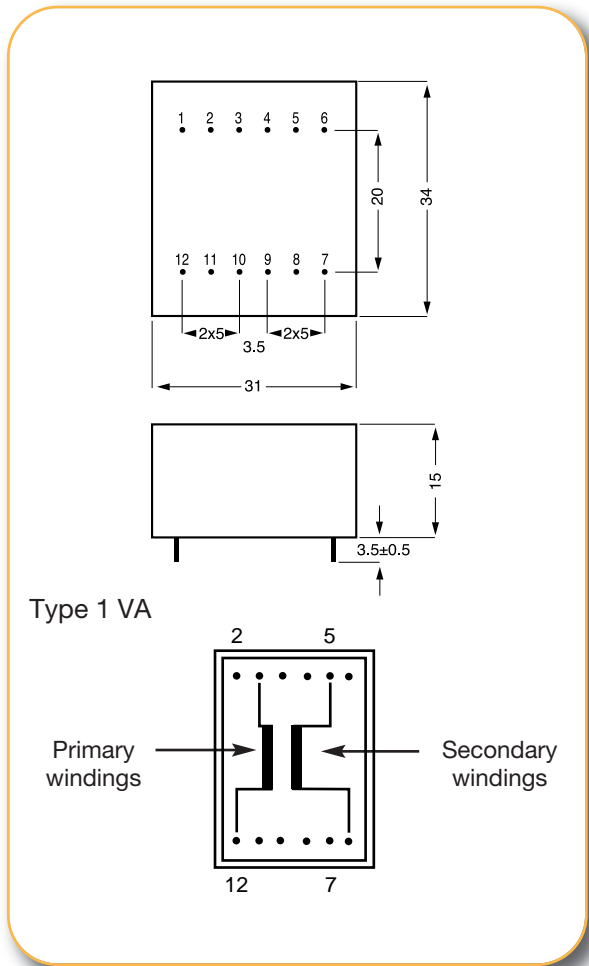

PRIMARY VOLTAGE 230 V					
Protection	Reference	Secondary voltage V	Secondary current mA	No-load voltage V	Ambient Temperature °C
UI 21		230 V		1 VA	
	45001	6	167	11,4	T 70 B
	45002	9	111	17	T 70 B
	45003	12	83	22,8	T 70 B
	45004	15	67	28,5	T 70 B
	45005	18	56	34,2	T 70 B
	45006	24	42	45,6	T 70 B

QUALITY IN SERIES



PRIMARY VOLTAGE 115 V - 230 V

Protection	Reference	Secondary voltage V	Secondary current mA	No-load voltage V	Ambient Temperature °C
UI 30 x 5,5		2 VA			
	45292	2 x 6	2 x 167	2 x 10,2	T 70 B
	45293	2 x 9	2 x 111	2 x 15,9	T 70 B
	45294	2 x 12	2 x 83	2 x 20,4	T 70 B
	45295	2 x 15	2 x 67	2 x 25,5	T 70 B
	45296	2 x 18	2 x 56	2 x 30,6	T 70 B
	45297	2 x 24	2 x 42	2 x 40,8	T 70 B
UI 30 x 5,5		Secondary protection mA		3 VA	
250	45013	2 x 6	2 x 250	2 x 9,8	T 70 B
160	45014	2 x 9	2 x 167	2 x 14,7	T 70 B
125	45015	2 x 12	2 x 125	2 x 19,6	T 70 B
100	45016	2 x 15	2 x 100	2 x 24,5	T 70 B
80	45017	2 x 18	2 x 83	2 x 29,5	T 70 B
63	45018	2 x 24	2 x 63	2 x 39,3	T 70 B
UI 30 x 7,5		Secondary protection mA		4 VA	
315	45019	2 x 6	2 x 333	2 x 9,4	T 70 B
250	45020	2 x 9	2 x 222	2 x 14,0	T 70 B
160	45021	2 x 12	2 x 167	2 x 18,6	T 70 B
125	45022	2 x 15	2 x 133	2 x 23,3	T 70 B
125	45023	2 x 18	2 x 111	2 x 28,0	T 70 B
80	45024	2 x 24	2 x 83	2 x 37,4	T 70 B
UI 30 x 10,5		Secondary protection mA		6 VA	
500	45025	2 x 6	2 x 500	2 x 8,1	T 70 B
315	45026	2 x 9	2 x 333	2 x 12,1	T 70 B
250	45027	2 x 12	2 x 250	2 x 16,2	T 70 B
200	45028	2 x 15	2 x 200	2 x 20,2	T 70 B
160	45029	2 x 18	2 x 167	2 x 24,3	T 70 B
125	45030	2 x 24	2 x 125	2 x 32,3	T 70 B
UI 30 x 16,5		Primary protection mA		10 VA	
125/63	45031	2 x 6	2 x 833	2 x 7,9	T 50 B
125/63	45032	2 x 9	2 x 556	2 x 11,9	T 50 B
125/63	45033	2 x 12	2 x 417	2 x 15,9	T 50 B
125/63	45034	2 x 15	2 x 333	2 x 19,8	T 50 B
125/63	45035	2 x 18	2 x 278	2 x 23,7	T 50 B
125/63	45036	2 x 24	2 x 208	2 x 31,7	T 50 B

- 115 V- 230 V supply voltage by series/parallel connection
- Vacuum filling
- Two compartments bobbins
- Degree of protection IP 00
- Resin class UL 94 V0

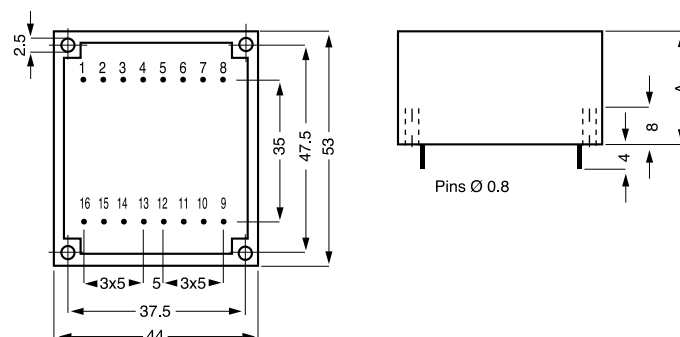

CIRCUIT	RATING	DIMENSION A	WEIGHT
UI 30 x 5,5	2 VA/3 VA	A = 17 mm	125 g
UI 30 x 7,5	4 VA	A = 19 mm	150 g
UI 30 x 10,5	6 VA	A = 22 mm	185 g
UI 30 x 16,5	10 VA	A = 28 mm	260 g

Possible primary connections

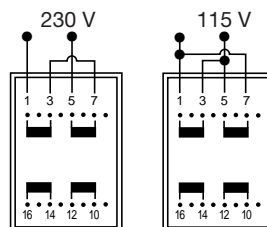

Possible secondary connections

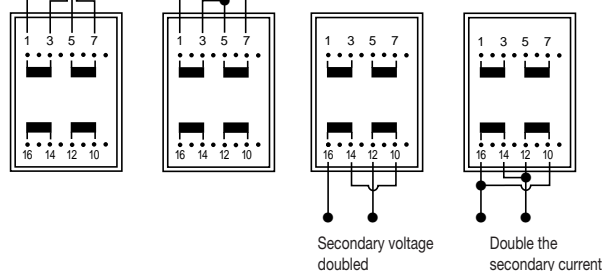

QUALITY IN SERIES



EN 60950 UL 5085

- Fuse protection in secondary winding (see diagram)
- Insulation voltage 4 KV
- 100 % tested production
- Conform to EN 61558
Approval under process
- UL 5085 approved

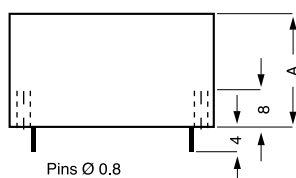
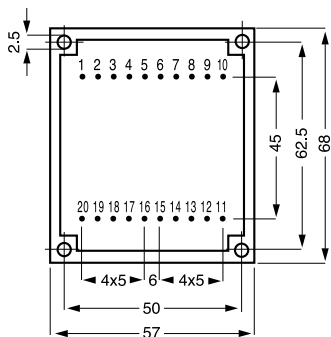

CIRCUIT	RATING	DIMENSION A	WEIGHT
UI 39 x 8	10 VA	A = 22 mm	285 g
UI 39 x 10,2	14 VA	A = 24 mm	335 g
UI 39 x 13,5	18 VA	A = 27 mm	405 g
UI 39 x 17	24 VA	A = 31 mm	480 g
UI 39 x 21	30 VA	A = 35 mm	550 g

Possible primary connections

Possible secondary connections

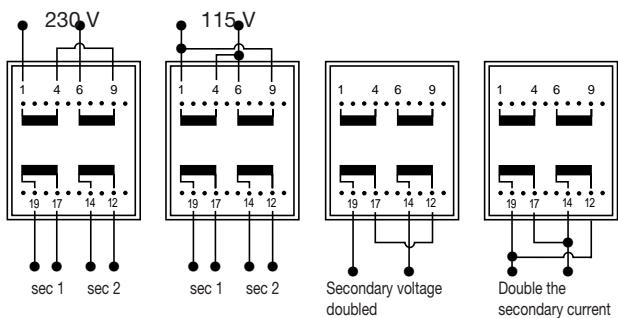

PRIMARY VOLTAGE 115 V - 230 V

Primary protection 115 V/230 V mA	Reference	Secondary voltage V	Secondary current mA	No-load voltage V	Ambient Temperature °C
UI 39 x 8		10 VA			
125/63	45037	2 x 6	2 x 833	2 x 8,2	T 50 B
125/63	45038	2 x 9	2 x 555	2 x 12,3	T 50 B
125/63	45039	2 x 12	2 x 416	2 x 16,4	T 50 B
125/63	45040	2 x 15	2 x 333	2 x 20,5	T 50 B
125/63	45041	2 x 18	2 x 277	2 x 24,6	T 50 B
125/63	45042	2 x 24	2 x 208	2 x 32,8	T 50 B
UI 39 x 10,2		14 VA			
160/80	45043	2 x 6	2 x 1167	2 x 7,5	T 50 B
160/80	45044	2 x 9	2 x 778	2 x 10,9	T 50 B
160/80	45045	2 x 12	2 x 583	2 x 15,0	T 50 B
160/80	45046	2 x 15	2 x 467	2 x 18,7	T 50 B
160/80	45047	2 x 18	2 x 389	2 x 22,4	T 50 B
160/80	45048	2 x 24	2 x 292	2 x 30,2	T 50 B
UI 39 x 13,5		18 VA			
200/100	45049	2 x 6	2 x 1500	2 x 7,4	T 50 B
200/100	45050	2 x 9	2 x 1000	2 x 11,0	T 50 B
200/100	45051	2 x 12	2 x 750	2 x 14,7	T 50 B
200/100	45052	2 x 15	2 x 600	2 x 18,3	T 50 B
200/100	45053	2 x 18	2 x 500	2 x 22,0	T 50 B
200/100	45054	2 x 24	2 x 375	2 x 29,4	T 50 B
UI 39 x 17		24 VA			
250/125	45055	2 x 6	2 x 2000	2 x 7,1	T 50 B
250/125	45056	2 x 9	2 x 1333	2 x 10,6	T 50 B
250/125	45057	2 x 12	2 x 1000	2 x 14,1	T 50 B
250/125	45058	2 x 15	2 x 800	2 x 17,6	T 50 B
250/125	45059	2 x 18	2 x 667	2 x 21,2	T 50 B
250/125	45060	2 x 24	2 x 500	2 x 28,3	T 50 B
UI 39 x 21		30 VA			
315/160	45061	2 x 6	2 x 2500	2 x 6,7	T 50 B
315/160	45062	2 x 9	2 x 1667	2 x 10,15	T 50 B
315/160	45063	2 x 12	2 x 1250	2 x 13,5	T 50 B
315/160	45064	2 x 15	2 x 1000	2 x 16,8	T 50 B
315/160	45065	2 x 18	2 x 833	2 x 20,2	T 50 B
315/160	45066	2 x 24	2 x 625	2 x 27,0	T 50 B

ENCAPSULATED TRANSFORMERS

45000 SERIES



EN 61558-2-6

EN 60950

UL 5085



- 115 V- 230 V supply voltage by series/parallel connection
- Vacuum filling
- Two compartments bobbins
- Degree of protection IP 00
- Resin class UL 94 V0

- Fuse protection in secondary winding (see diagram)
- Insulation voltage 4 KV
- 100 % tested production
- Conform to EN 61558 Approval under process
- UL 5085 approved

PRIMARY VOLTAGE 115 V - 230 V					
Primary protection 115/230 V mA	Reference	Secondary voltage V	Secondary current mA	No-load voltage V	Ambient Temperature °C
UI 48 x 17			40 VA		
400/200	45067	2 x 6	2 x 3333	2 x 6,7	T 50 B
400/200	45068	2 x 9	2 x 2222	2 x 10,0	T 50 B
400/200	45069	2 x 12	2 x 1667	2 x 13,4	T 50 B
400/200	45070	2 x 15	2 x 1333	2 x 16,7	T 50 B
400/200	45071	2 x 18	2 x 1111	2 x 20,1	T 50 B
400/200	45072	2 x 24	2 x 833	2 x 26,8	T 50 B
UI 48 x 26			60 VA		
630/315	45073	2 x 6	2 x 5000	2 x 6,6	T 50 B
630/315	45074	2 x 9	2 x 3333	2 x 9,9	T 50 B
630/315	45075	2 x 12	2 x 2500	2 x 13,1	T 50 B
630/315	45076	2 x 15	2 x 2000	2 x 16,4	T 50 B
630/315	45077	2 x 18	2 x 1667	2 x 19,7	T 50 B
630/315	45078	2 x 24	2 x 1250	2 x 26,3	T 50 B

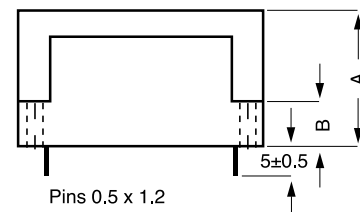
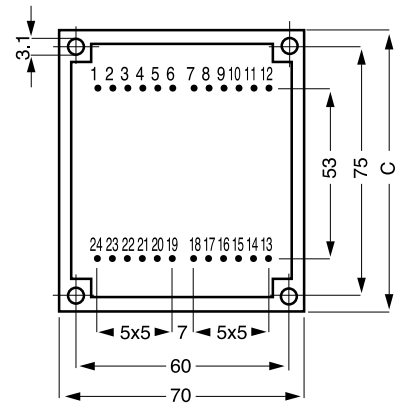

CIRCUIT	RATING	A	B	C	WEIGHT
UI 48 x 17	40 VA	38,5	13,5	83	760 g
UI 48 x 26	60 VA	48,5	14,5	86	1060 g

Possible primary connections

Possible secondary connections

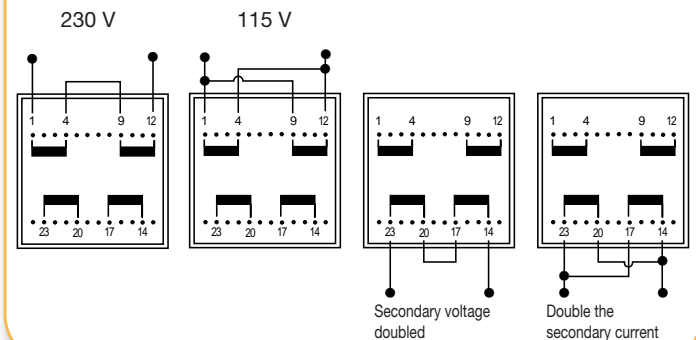

QUALITY IN SERIES



SIDE-MOUNTING TRANSFORMERS

• FLF / FLC SERIES

- Primary voltage : 230 V 50/60 Hz
- Secondary voltage : 12 V ou 24 V
- Maximum ambient temperature : + 40 °C
- Insulation class : B
- Insulation voltage : 4 kV
- Standards applicable : VDE 0570 - EN 61558 - UL 5085
- Degree of protection IP 00

- Prepared for protection class II

- Options : 00 Standard

01 Addition of a thermal fuse
(non-resettable)

02 Addition of a resettable thermal
protection system

- On request : all primary and secondary voltages up to 500 V (consult us for details)

• FLF SERIES : connection by UL-approved flexible

cables (600 V/105°C)

AWG 18 up to 6 A

AWG 16 up to 10 A

AWG 14 up to 20 A

standard length :
250 mm

• FLC SERIES : connection by «faston» connectors

Rating

primary

secondary

3,2 VA-5 VA

2,8 x 0,8

4,8 x 0,8

10 VA-22 VA

4,8 x 0,8

4,8 x 0,8

30 VA-240 VA

6,3 x 0,8

6,3 x 0,8

FLF SERIES

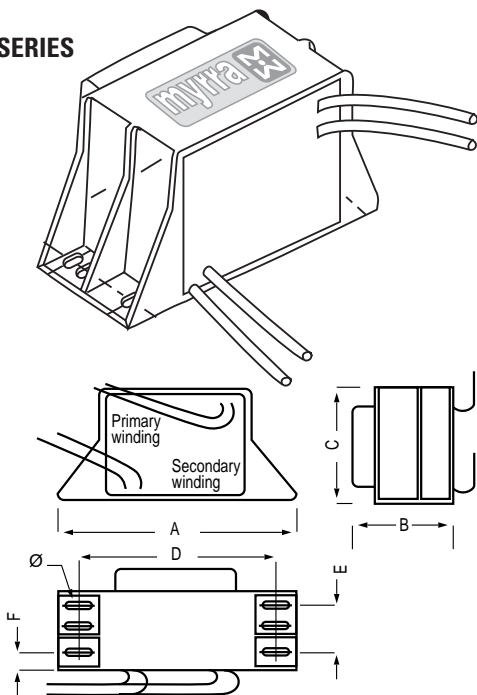

FLC SERIES

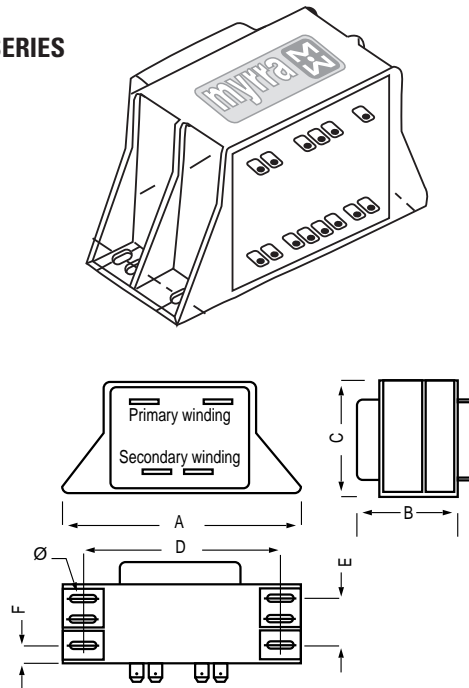

Rating in VA	References				Drop %	Vs-c %	Effic. %	Fuse	Format	A	B	C	D	E	F	Ø
	FLF		FLC													
	12 V	24 V	12 V	24 V												
3,2	30081	30094	30107	30120	30	28	61	32 mA	EI 38 x 13,6	61	33	35	51	-	19,5	3,5
5	30082	30095	30108	30121	32	30	62	32 mA	EI 42 x 14,8	65	33	38	55	-	17,8	3,5
10	30083	30096	30109	30122	25	25	69	63 mA	EI 48 x 16,8	75	39	43	62	12	9	3,5
16	30084	30097	30110	30123	24	23	71,5	80 mA	EI 54 x 18,4	82,5	43	48,5	68	11	11	3,5
22	30085	30098	30111	30124	19	19	76,5	125 mA	EI 60 x 21	88	48	53,5	75	13,5	12,2	4,8
30	30086	30099	30112	30125	16	16	79,5	160 mA	EI 66 x 23	94	49,5	58,5	82	13	13,3	4,8
45	30087	30100	30113	30126	11	11	83	250 mA	EI 66 x 34,7	94	61	58,5	82	37,5	7,4	4,8
63	30088	30101	30114	30127	12	13	83,5	315 mA	EI 78 x 27,5	112,5	59	71,5	97,5	32,5	7,6	5,2
100	30089	30102	30115	30128	13,5	15	84,5	500 mA	EI 84 x 29,5	120	64	75	102,5	32,5	10,2	5,5
160*	30090	30103	30116	30129	12	13,5	86	800 mA	EI 84 x 43,5	120	78	75	102,5	45	10,8	5,5
160	30091	30104	30117	30130	9,5	12	88,5	800 mA	EI 96 x 35,7	133	75	85	115	40	10,6	5,5
185	30092	30105	30118	30131	7,8	9,8	90	1,0 A	EI 96 x 45,7	133	85	85	115	50	10,6	5,2
240	30093	30106	30119	30132	6,4	8	91	1,25 A	EI 96 x 59,7	133	98,5	85	115	64	10,2	5,5

* Transformer not complying with the standard (for this, it must be equipped with a thermal fuse system)



MYRRA Part N°	CORE SIZE	Max. Output Power	Outputs				
		Watts	Vdc nominal voltage				
74000	E16	5w	5v	12v			
74001	E16	6w	5v				
74002	E16	6w	12v				
74003	E16	5w	3.3v	5v			
74010	E16	12w	5v	12v			
74014	E16	12w	24v	24v			
74015	E16	12w	5v	15v	24v		
74020	EL19	18w	5v	12v			
74021	EL19	18w	5v	12v			
74023	EL19	16w	3.3v	5v	12v	18v	30v
74030	E25	30w	5v	12v	12v		
74032	E25	35w	24v				
74040	ETD29	60w	5v	12v	5v	12v	
74043	ERL28	60w	3.3v	5v	12v	18v	30v
74050	ETD34	90w	5v	12v	5v	12v	
74060	ETD39	140w	5v	12v	5v	12v	
74070	ETD44	180w	5v	12v	5v	12v	
74080	EF20	24w	12v	12v			
74081	EF20	20w	3.3v	5v	12v		
74082	EF20	20w	5v	5v			
74090	E16	1.5w	5v				
74091	E16	1.5w	12v				
74092	E16	3.1w	5v				
74093	E16	3.1w	12v				
74094	E16	9w	5v				
74095	E16	9w	12v				

Note : "5 volts" outputs can generally be used for 3.3 to 6volts; "12 volts" outputs can be used for 9 to 16volts.
See detailed characteristics.



Transformer Reference		IC Manufacturer	Series & References
74090 74091 74092 74093 74094 74095	No aux. Winding	PI	TNY Series LNK XT Series

74000 74001 74002 74003 74004 74005 74010 74014 74015 74020 74021 74023 74080 74081 74082 74087 74088 74089 74030 74032 74040 74043 74050 74060 74070	With aux. Winding	ONSEMI	NCP 1014 NCP 3065 etc.
		PI	TOP Series LNK Series
		NXP	TEA1530 TEA1351 TEA3065 etc.
		ST	Viper Series
		FAIRCHILD	FAN102 FAN400 FSEZ130 FSEZ1213 etc.
		ON Bright	OB2535 OB2212 OB2361 etc.

HIGH FREQUENCY FERRITE
POWER FERRITE TRANSFORMERS



- Primary / Secondary Insulation $\geq 4000V$
- Creepage distance Primary / Secondary $\geq 6mm$
- Ambient temperature $< 85^{\circ}C$
- Construction conforms to IEC950, IEC335, IEC61558-2-16 for reinforced insulation
- Exclusively uses UL94-V0 listed materials

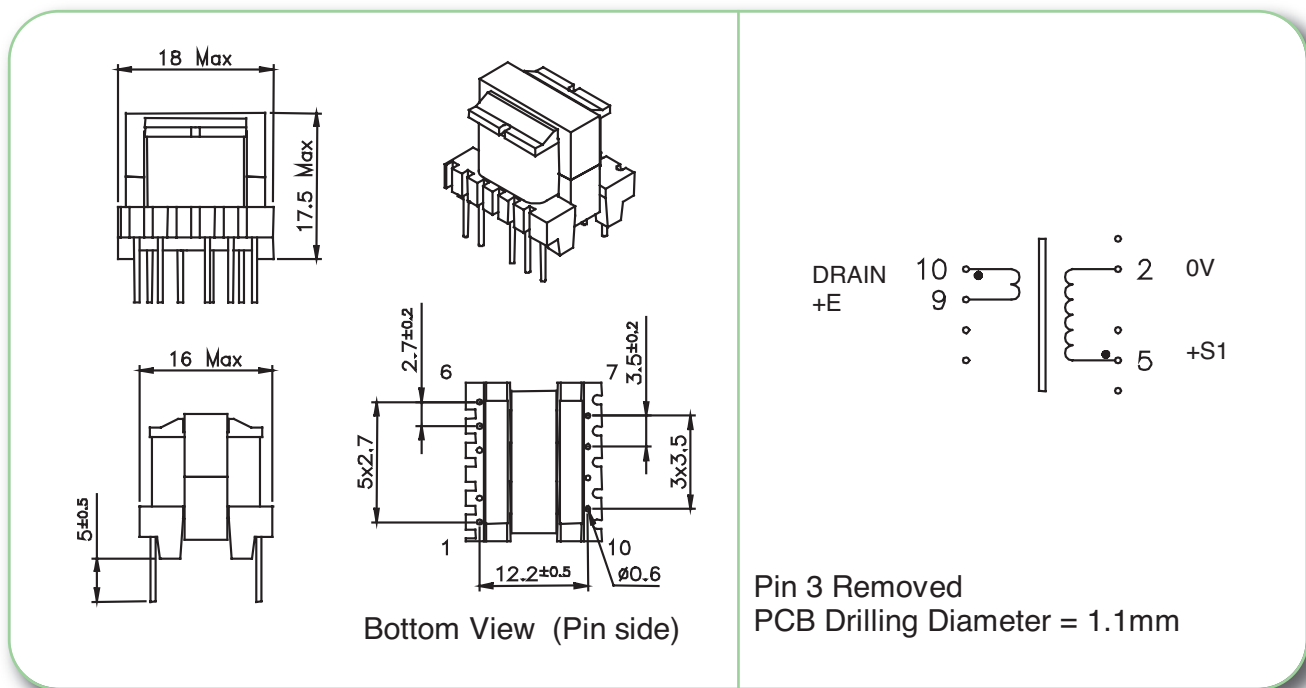

MYRRA P / N	Output Power maximum	Windings					
			Pins	Turns	Voltage	Current maximum	Inductance (+/-10%)
74090	1.5 w	Pri	10 – 9	228	85 - 265Vrms	0.28 Apeak	6000µH
		S1	5 – 2	16	3.3 – 6 Vdc	0.4 Adc	
74091	1.5 w	Pri	10 – 9	228	85 - 265Vrms	0.28 Apeak	6000µH
		S1	5 – 2	28	7.5 – 15 Vdc	0.2 Adc	

Examples of application with Integrated Circuits :

MYRRA P / N	Control IC Manufacturer	Input voltage	Power	Frequency
74090	Power Integrations	85 - 265Vrms	1.5w	44kHz
74091	Power Integrations	85 - 265Vrms	1.5w	44kHz

HIGH FREQUENCY FERRITE
POWER FERRITE TRANSFORMERS



- Primary / Secondary Insulation $\geq 4000V$
- Creepage distance Primary / Secondary $\geq 6mm$
- Ambient temperature $< 70^{\circ}C$
- Construction conforms to IEC950, IEC335, IEC61558-2-16 for reinforced insulation
- Exclusively uses UL94-V0 listed materials

Bottom View (Pin side)

Pin 3 Removed
PCB Drilling Diameter = 1.1mm

MYRRA P / N	Output Power maximum	Windings					
			Pins	Turns	Voltage	Current maximum	Inductance (+/-10%)
74092	3.1 w	Pri	10 – 9	191	85 - 265Vrms	0.34 Apeak	4200µH
		S1	5 – 2	13	3.3 – 6 Vdc	0.9 Adc	
74093	3.1 w	Pri	10 – 9	191	85 - 265Vrms	0.34 Apeak	4200µH
		S1	5 – 2	24	7.5 – 15 Vdc	0.4 Adc	

Examples of application with Integrated Circuits :

MYRRA P / N	Control IC Manufacturer	Input voltage	Power	Frequency
74092	Power Integrations	85 - 265Vrms	3.1w	44kHz
74093	Power Integrations	85 - 265Vrms	3.1w	44kHz

HIGH FREQUENCY FERRITE
POWER FERRITE TRANSFORMERS



- Primary / Secondary Insulation $\geq 4000V$
- Creepage distance Primary / Secondary $\geq 6mm$
- Ambient temperature $< 60^{\circ}C$
- Construction conforms to IEC950, IEC335, IEC61558-2-16 for reinforced insulation
- Exclusively uses UL94-V0 listed materials

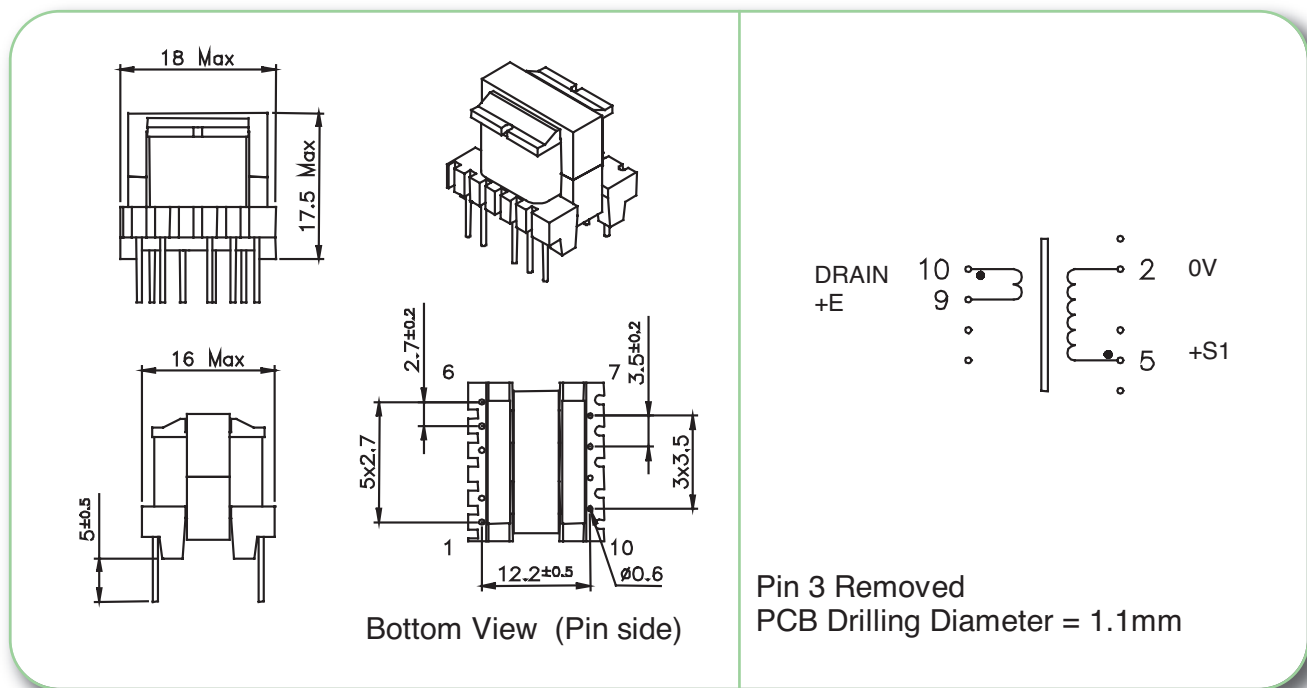

MYRRA P / N	Output Power maximum	Windings					
			Pins	Turns	Voltage	Current maximum	Inductance (+/-10%)
74094	9 w	Pri	10 – 9	135	85 - 265Vrms	0.48 Apeak	2100µH
		S1	5 – 2	9	3.3 – 6 Vdc	1.5 Adc	
74095	9 w	Pri	10 – 9	135	85 - 265Vrms	0.48 Apeak	2100µH
		S1	5 – 2	17	7.5 – 15 Vdc	0.9 Adc	

Examples of application with Integrated Circuits :

MYRRA P / N	Control IC Manufacturer	Input voltage	Power	Frequency
74094	Power Integrations	85 - 265Vrms	4.2w	44kHz
	Power Integrations	85 - 265Vrms	5w	132kHz
	Power Integrations	85 - 265Vrms	9w	132kHz
74095	Power Integrations	85 - 265Vrms	5w	44kHz
	Power Integrations	85 - 265Vrms	5w	132kHz
	Power Integrations	85 - 265Vrms	9w	132kHz

HIGH FREQUENCY FERRITE
POWER FERRITE TRANSFORMERS



- Primary / Secondary Insulation $\geq 4000V$
- Primary / Auxiliary Insulation $\geq 1500V$
- Creepage distance Primary / Secondary $\geq 6mm$
- Ambient temperature $< 70^{\circ}C$
- Construction conforms to IEC950, IEC335, IEC61558-2-16 for reinforced insulation
- Exclusively uses UL94-V0 listed materials

18 Max
17.5 Max
16 Max
5±0.5
2.7±0.2
6
7
3.5±0.2
10
12.2±0.5
Ø0.6
3x3.5

+E 6
 DRAIN 4
 +AUX 2
 0V 1

7 +S2
 8 0V
 9 +S1
 10 0V

74000

PIN 3 Removed
PCB Drilling Diameter = 1.1mm

Bottom View (Pin side)

MYRRA P / N	Output Power maximum	Windings					
			Pins	Turns	Voltage	Current maximum	Inductance (+/-10%)
74000	5 w	Pri	4 - 6	138	85 - 265Vrms	0.27 Apeak	3900µH
		Aux	2 - 1	16	7 – 14 Vdc	0.1 Adc	
		S1	9 - 10	8	3.3 – 7 Vdc	1.2 Adc	
		S2	7 - 8	19	8 – 17 Vdc	0.4 Adc	

Examples of application with Integrated Circuits :

MYRRA P / N	Control IC Manufacturer	Input voltage	Power	Frequency
74000	Power Integrations	85 - 265Vrms	5w	132kHz
	ST Microelectronics	85 - 265Vrms	4w	70kHz

HIGH FREQUENCY FERRITE
POWER FERRITE TRANSFORMERS



- Primary / Secondary Insulation $\geq 4000V$
- Primary / Auxiliary Insulation $\geq 1500V$
- Creepage distance Primary / Secondary $\geq 6mm$
- Ambient temperature $< 60^{\circ}C$
- Construction conforms to IEC950, IEC335, IEC61558-2-16 for reinforced insulation
- Exclusively uses UL94-V0 listed materials

Bottom View (Pin side)

PIN 3 Removed
PCB Drilling Diameter = 1.1mm

MYRRA P / N	Output Power maximum	Windings					
			Pins	Turns	Voltage	Current maximum	Inductance (+/-10%)
74001	6 w	Pri	4 - 6	138	85 - 265Vrms	0.35 Apeak	3000µH
		Aux	2 - 1	20	8 - 16 Vdc	0.1 Adc	
		S1	9 - 10	8	3 - 6 Vdc	1.2 Adc	
74002	6 w	Pri	4 - 6	150	85 - 265Vrms	0.38 Apeak	3000µH
		Aux	2 - 1	22	8.5 - 17 Vdc	0.1 Adc	
		S1	9 - 10	24	9 - 18 Vdc	0.5 Adc	

Examples of application with Integrated Circuits :

MYRRA P / N	Control IC Manufacturer	Input voltage	Power	Frequency
74001	Power Integrations	85 - 265Vrms	6w	132kHz
	ST Microelectronics	85 - 265Vrms	6w	70kHz
	ST Microelectronics	85 - 265Vrms	3w	40kHz
	Motorola	85 - 265Vrms	6w	100kHz
	Infineon	185 - 265Vrms	6w	100kHz
74002	Power Integrations	85 - 265Vrms	6w	132kHz
	ST Microelectronics	85 - 265Vrms	6w	70kHz
	ST Microelectronics	85 - 265Vrms	3w	40kHz
	Motorola	85 - 265Vrms	6w	100kHz
	Infineon	185 - 265Vrms	6w	100kHz

HIGH FREQUENCY FERRITE
POWER FERRITE TRANSFORMERS



- Primary / Secondary Insulation $\geq 4000V$
- Primary / Auxiliary Insulation $\geq 1500V$
- Creepage distance Primary / Secondary $\geq 6mm$
- Ambient temperature $< 60^{\circ}C$
- Construction conforms to IEC950, IEC335, IEC61558-2-16 for reinforced insulation
- Exclusively uses UL94-V0 listed materials

Bottom View (Pin side)

PIN 3 Removed
PCB Drilling Diameter = 1.1mm

MYRRA P / N	Output Power maximum	Windings					
			Pins	Turns	Voltage	Current maximum	Inductance (+/-10%)
74003	6 w	Pri	4 - 6	120	85 - 265Vrms	0.3 Apeak	3000µH
		Aux	2 - 1	17	8 – 16 Vdc	0.1 Adc	
		S1	9 - 10	5	2 – 4 Vdc	1.8 Adc	
		S2	7 - 10	7	3 – 6 Vdc	1.2 Adc	

Examples of application with Integrated Circuits :

MYRRA P / N	Control IC Manufacturer	Input voltage	Power	Frequency
74003	Power Integrations	85 - 265Vrms	5w	132kHz
	ST Microelectronics	85 - 265Vrms	6w	70kHz
	ST Microelectronics	85 - 265Vrms	3w	40kHz
	Motorola	85 - 265Vrms	6w	100kHz
	Infineon	185 - 265Vrms	6w	100kHz

HIGH FREQUENCY FERRITE
POWER FERRITE TRANSFORMERS



- Primary / Secondary Insulation ≥ 4000 V
- Primary / Auxiliary Insulation ≥ 1500 V
- Creepage distance Primary / Secondary ≥ 6 mm
- Ambient temperature $< 50^{\circ}\text{C}$
- Construction conforms to IEC950, IEC335, IEC61558-2-16 for reinforced insulation
- Exclusively uses UL94 V-0 listed materials

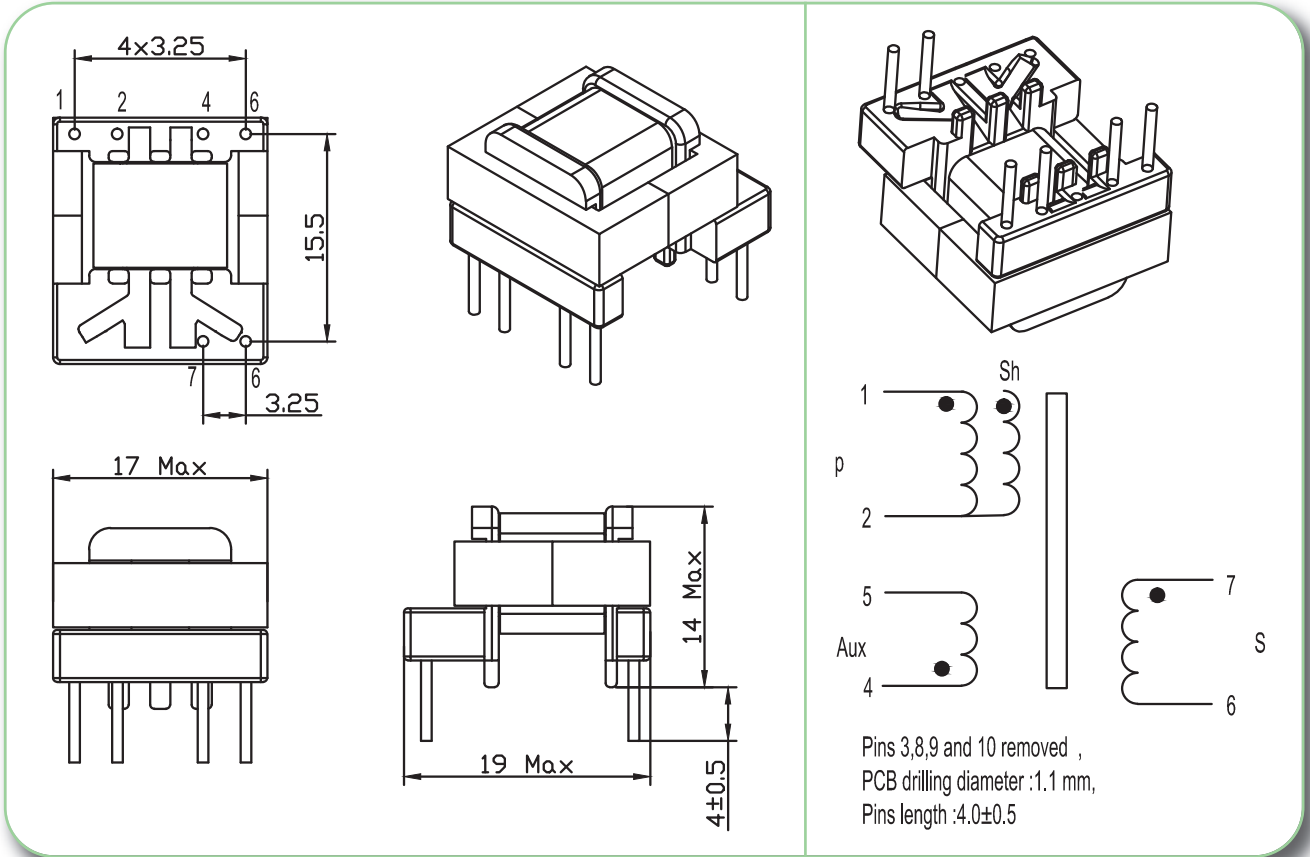

MYRRA P/N	Output Power maximum	Windings					
			Pins	Turns	Voltage	Current maximum	Inductance (+/-10%)
74004	1.7 w	Pri	1 - 2	108	85 - 265Vrms	0.28 Apeak	2700 μH
		Aux	5 - 4	25	22 Vdc	0.1 Adc	
		S	7 - 6	8	6 Vdc	0.5 Adc	
		Shield	NC - 2	8			

Examples of application with Integrated Circuits :

MYRRA P/N	Control IC Manufacturer	Control IC P/N	Input voltage	Power	Frequency
74004	Power Integrations	LNK562	185 - 265 Vrms	1.3 W	66 kHz
	Power integrations	LNK562	85 - 265 Vrms	1.3 W	66 kHz
	Power Integrations	LNK563	185 - 265 Vrms	1.7 W	83 kHz
	Power Integrations	LNK563	85 - 265 Vrms	1.7 W	83 kHz
	Power Integrations	LNK564	185 - 265 Vrms	2.0 W	100 kHz
	Power Integrations	LNK564	85 - 265 Vrms	2.0 W	100 kHz

Remarks : This transformer perfectly fulfils the specification of Power Integrations AN-39 Appendix - A.



- Primary / Secondary Insulation ≥ 4000 V
- Primary / Auxiliary Insulation ≥ 1500 V
- Creepage distance Primary / Secondary ≥ 6 mm
- Ambient temperature $< 50^{\circ}\text{C}$
- Construction conforms to IEC950, IEC335, IEC61558-2-16 for reinforced insulation
- Exclusively uses UL94 V-0 listed materials

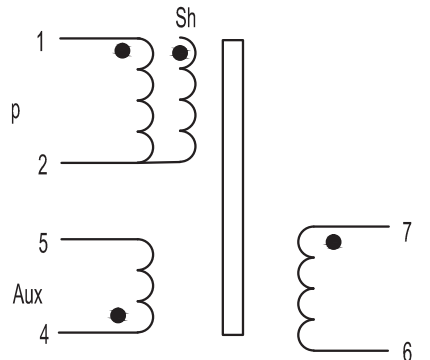
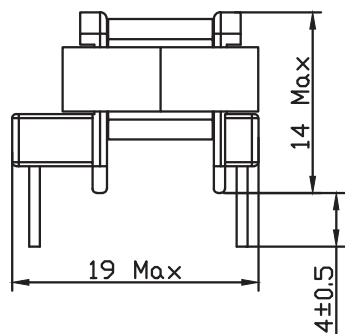
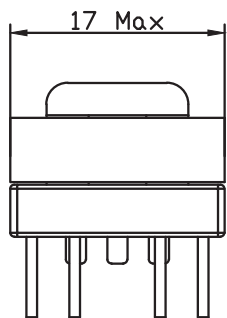
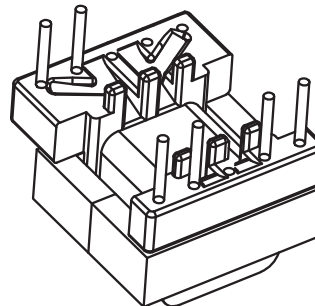
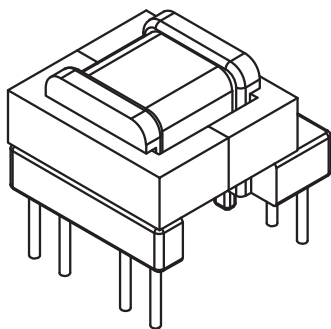
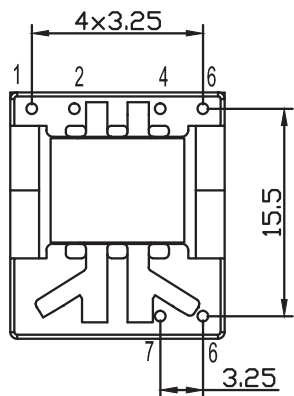

Pins 3,8,9 and 10 removed ,
PCB drilling diameter :1.1 mm,
Pins length :4.0±0.5

MYRRA P/N	Output Power maximum	Windings					
			Pins	Turns	Voltage	Current maximum	Inductance (+/-10%)
74005	1.7 w	Pri	1 - 2	108	85 - 265Vrms	0.28 Apeak	2700 μH
	Aux	5 - 4	25	22 Vdc	0.1 Adc		
	S	7 - 6	12	10 Vdc	0.2 Adc		
	Shield	NC - 2	8				

Examples of application with Integrated Circuits :

MYRRA P/N	Control IC Manufacturer	Control IC P/N	Input voltage	Power	Frequency
74005	Power Integrations	LNK562	185 - 265 Vrms	1.3 W	66 kHz
	Power integrations	LNK562	85 - 265 Vrms	1.3 W	66 kHz
	Power Integrations	LNK563	185 - 265 Vrms	1.7 W	83 kHz
	Power Integrations	LNK563	85 - 265 Vrms	1.7 W	83 kHz
	Power Integrations	LNK564	185 - 265 Vrms	2.0 W	100 kHz
	Power Integrations	LNK564	85 - 265 Vrms	2.0 W	100 kHz

Remarks : This transformer perfectly fulfils the specification of Power Integrations AN-39 Appendix - B.



- Primary / Secondary Insulation $\geq 4000V$
- Primary / Auxiliary Insulation $\geq 1500V$
- Creepage distance Primary / Secondary $\geq 6mm$
- Ambient temperature $< 50^{\circ}C$
- Construction conforms to IEC950, IEC335, IEC61558-2-16 for reinforced insulation
- Exclusively uses UL94-V0 listed materials

+E 6

DRAIN 4

+AUX 2

0V 1

7 +S2

8 0V

9 +S1

10 0V

74010

PIN 3 Removed
PCB Drilling Diameter = 1.1mm

MYRRA P / N	Output Power maximum	Windings					
			Pins	Turns	Voltage	Current maximum	Inductance (+/-10%)
74010	12 w	Pri	4 - 6	120	85 - 265Vrms	0.55 Apeak	1660µH
		Aux	2 - 1	14	7 - 14 Vdc	0.1 Adc	
		S1	9 - 10	7	3.3 - 7 Vdc	2 Adc	
		S2	7 - 8	17	8 - 17 Vdc	1 Adc	

Examples of application with Integrated Circuits :

MYRRA P / N	Control IC Manufacturer	Input voltage	Power	Frequency
74010	Power Integrations	185 - 265Vrms	12w	132kHz
	Power Integrations	85 - 265Vrms	10w	132kHz
	Power Integrations	185 - 265Vrms	12w	132kHz
	Power Integrations	85 - 265Vrms	10w	132kHz
	Power Integrations	185 - 265Vrms	12w	132kHz
	ST Microelectronics	85 - 265Vrms	8w	70kHz
	ST Microelectronics	185 - 265Vrms	10w	70kHz
	Motorola	85 - 265Vrms	8w	100kHz
	Motorola	185 - 265Vrms	10w	100kHz
	Infineon	92 - 265Vrms	7,5w	100kHz
	Infineon	185 - 265Vrms	10w	100kHz
	Fairchild	85 - 265Vrms	7w	50kHz
Fairchild	185 - 265Vrms	10w	100kHz	

HIGH FREQUENCY FERRITE
POWER FERRITE TRANSFORMERS



- Primary / Secondary Insulation $\geq 4000V$
- Primary / Auxiliary Insulation $\geq 1500V$
- Creepage distance Primary / Secondary $\geq 6mm$
- Ambient temperature $< 50^{\circ}C$
- Construction conforms to IEC950, IEC335, IEC61558-2-16 for reinforced insulation
- Exclusively uses UL94-V0 listed materials

Top View: 18 Max, 17.5 Max

Bottom View (Pin side): 16 Max, 5±0.5, 2.7±0.2, 6, 7, 3.5±0.2, 5x2.7, 10, 12.2±0.5, 3x3.5, Ø0.6

74014

Pin connections:
 +E: 6
 DRAIN: 4
 +AUX: 2
 0V: 1
 +S2: 7
 0V: 8
 +S1: 9
 0V: 10

PIN 3 Removed
PCB Drilling Diameter = 1.1mm

MYRRA P / N	Output Power maximum	Windings					
			Pins	Turns	Voltage	Current maximum	Inductance (+/-10%)
74014	12 w	Pri	4 - 6	120	85 - 265Vrms	0.5 Apeak	1800µH
		Aux	2 - 1	17	9 – 18 Vdc	0.2 Adc	
		S1	9 - 10	27	15 – 30 Vdc	0.4 Adc	
		S2	7 - 8	27	15 – 30 Vdc	0.4 Adc	

Typical outputs :
 +24V 0.5A with S1 – S2 in parallel
 +48V 0.25A with S1 – S2 in series (8-9 connected)
 +15V / -15V 0.4A with pins 8-9 connected to 0V

Examples of application with Integrated Circuits :

MYRRA P / N	Control IC Manufacturer	Input voltage	Power	Frequency
74014	Power Integrations	185 - 265Vrms	12w	
	Power Integrations	85 - 265Vrms	8w	
	Power Integrations	185 - 265Vrms	12w	132kHz
	Power Integrations	85 - 265Vrms	8w	132kHz

HIGH FREQUENCY FERRITE
POWER FERRITE TRANSFORMERS



- Primary / Secondary Insulation $\geq 4000V$
- Primary / Auxiliary Insulation $\geq 1500V$
- Creepage distance Primary / Secondary $\geq 6mm$
- Ambient temperature $< 50^{\circ}C$
- Construction conforms to IEC950, IEC335, IEC61558-2-16 for reinforced insulation
- Exclusively uses UL94-V0 listed materials

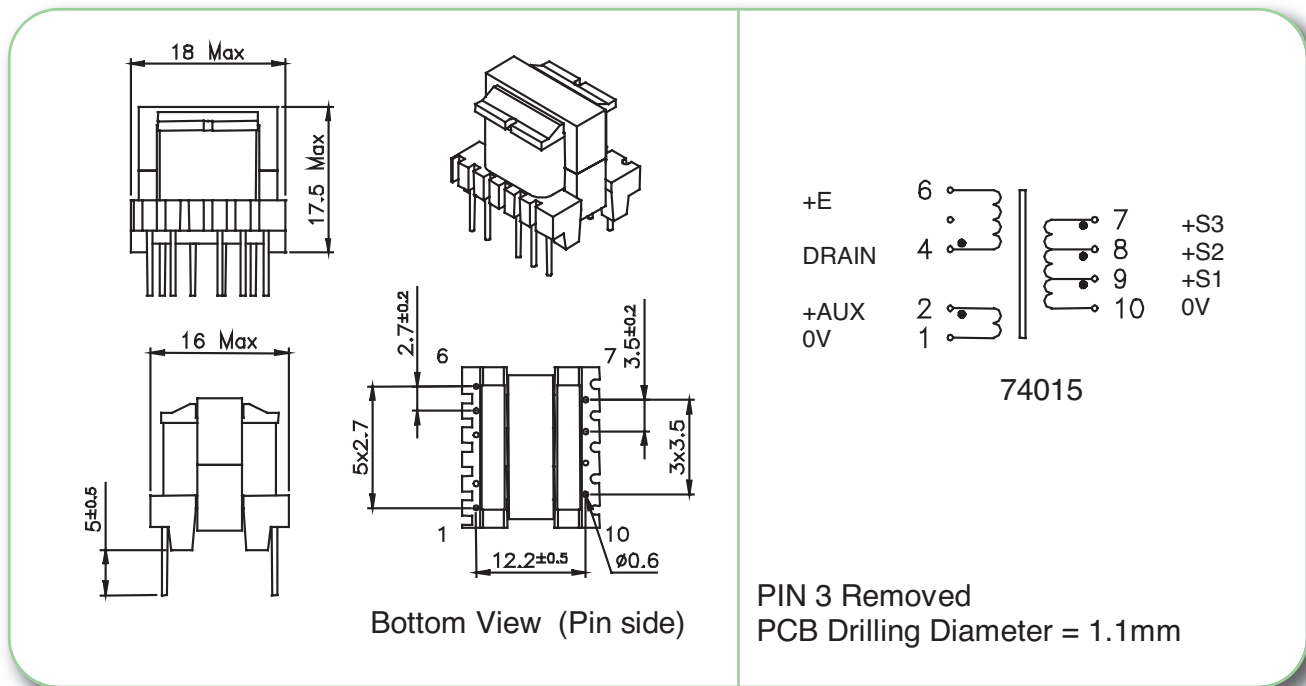

MYRRA P / N	Output Power maximum	Windings					
			Pins	Turns	Voltage	Current maximum	Inductance (+/-10%)
74015	12 w	Pri	4 - 6	120	85 - 265Vrms	0.5 Apeak	1800µH
		Aux	2 - 1	14	12 Vdc	0.2 Adc	
		S1	9 - 10	6	5 Vdc	1.5 Adc	
		S2	8 - 10	17	15 Vdc	0.6 Adc	
		S3	7 - 10	27	24 Vdc	0.4 Adc	

Examples of application with Integrated Circuits :

MYRRA P / N	Control IC Manufacturer	Input voltage	Power	Frequency
74015	Power Integrations	185 - 265Vrms	10w	
	Power Integrations	85 - 265Vrms	8w	
	Power Integrations	185 - 265Vrms	12w	132kHz
	Power Integrations	85 - 265Vrms	9w	132kHz

HIGH FREQUENCY FERRITE POWER FERRITE TRANSFORMERS



- Primary / Secondary Insulation $\geq 4000V$
- Primary / Auxiliary Insulation $\geq 1500V$
- Creepage distance Primary / Secondary $\geq 6mm$
- Ambient temperature $< 50^{\circ}C$
- Construction conforms to IEC950, IEC335, IEC61558-2-16 for reinforced insulation
- Exclusively uses UL94-V0 listed materials

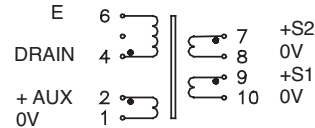
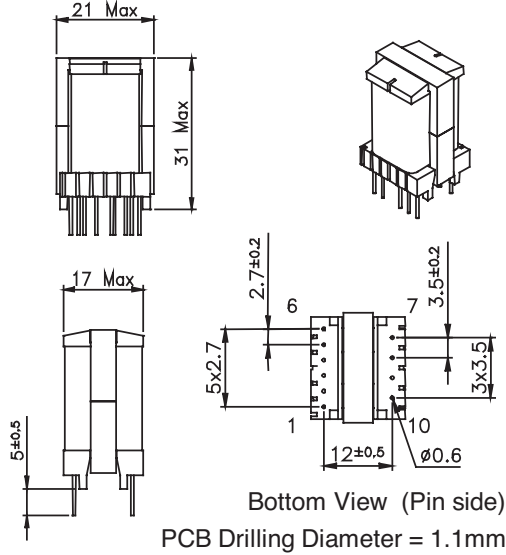

74020 / 74021

MYRRA P / N	Output Power maximum	Windings					
			Pins	Turns	Voltage	Current maximum	Inductance (+/-10%)
74020	18 w	Pri	4 - 6	108	85 - 265Vrms	0.8 Apeak	1250µH
		Aux	2 - 1	12	7 - 14 Vdc	0.1 Adc	
		S1	9 - 10	6	3.3 - 7 Vdc	3 Adc	
		S2	7 - 8	14	8 - 16.5 Vdc	1.4 Adc	
74021	18 w	Pri	4 - 6	108	85 - 265Vrms	1.1 Apeak	900µH
		Aux	2 - 1	12	7 - 14 Vdc	0.1 Adc	
		S1	9 - 10	6	3.3 - 7 Vdc	3 Adc	
		S2	7 - 8	14	8 - 16.5 Vdc	1.4 Adc	

Examples of application with Integrated Circuits :

MYRRA P / N	Control IC Manufacturer	Input voltage	Power	Frequency
74020	Power Integrations	85 - 265Vrms	15w	132kHz
	Power Integrations	185 - 265Vrms	18w	132kHz
	Power Integrations	85 - 265Vrms	12w	132kHz
	ST Microelectronics	85 - 265Vrms	10w	100kHz
	ST Microelectronics	185 - 265Vrms	12w	100kHz
	ST Microelectronics	185 - 265Vrms	16w	100kHz
	Motorola	185 - 265Vrms	16w	100kHz
	Infineon	185 - 265Vrms	16w	100kHz
74021	ST Microelectronics	85 - 265Vrms	13w	70kHz
	Motorola	85 - 265Vrms	13w	100kHz
	Infineon	92 - 265Vrms	10w	100kHz



- Primary / Secondary Insulation $\geq 4000V$
- Primary / Auxiliary Insulation $\geq 1500V$
- Creepage distance Primary / Secondary $\geq 6mm$
- Ambient temperature $< 60^{\circ}C$
- Construction conforms to IEC950, IEC335, IEC61558-2-16 for reinforced insulation
- Exclusively uses UL94-V0 listed materials

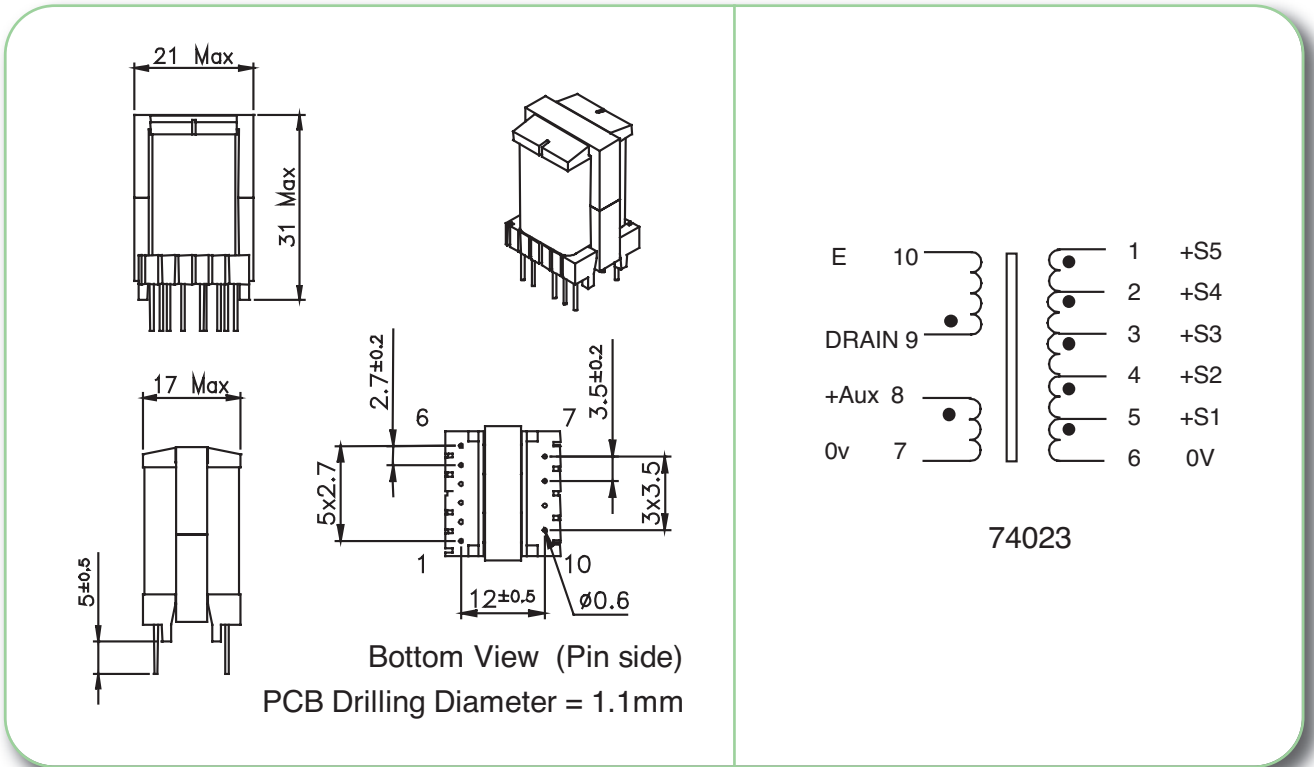

HIGH FREQUENCY FERRITE
POWER FERRITE TRANSFORMERS

MYRRA P/N	Output Power maximum	Windings					
			Pins	Turns	Voltage	Current maximum	Inductance (+/-10%)
74023	16 w	Pri	9 – 10	120	85 - 265Vrms	0.85 Apeak	1250µH
		Aux	8 – 7	17	15 Vdc	0.2 Adc	
		S1	5 – 6	4	3.3 Vdc	S1 + S2 : 7 Adc	
		S2	4 – 6	6	5 Vdc	S1 + S2 : 7 Adc	
		S3	3 – 6	14	12 Vdc	0.8 Adc	
		S4	2 – 6	20	18 Vdc	0.8 Adc	
S5	1 – 6	33	30 Vdc	0.2 Adc			

Examples of application with Integrated Circuits :

MYRRA P/N	Control IC Manufacturer	Input voltage	Power	Frequency
74023	Power Integrations	185 - 265Vrms	16w	132kHz
	Power Integrations	85 - 265Vrms	12w	132kHz



- Primary / Secondary Insulation $\geq 4000V$ • Primary / Auxiliary Insulation $\geq 1500V$
- Creepage distance Primary / Secondary $\geq 8mm$
- Ambient temperature $< 50^{\circ}C$
- Construction conforms to IEC950, IEC335, IEC61558-2-16 for reinforced insulation
- Exclusively uses UL94-V0 listed materials

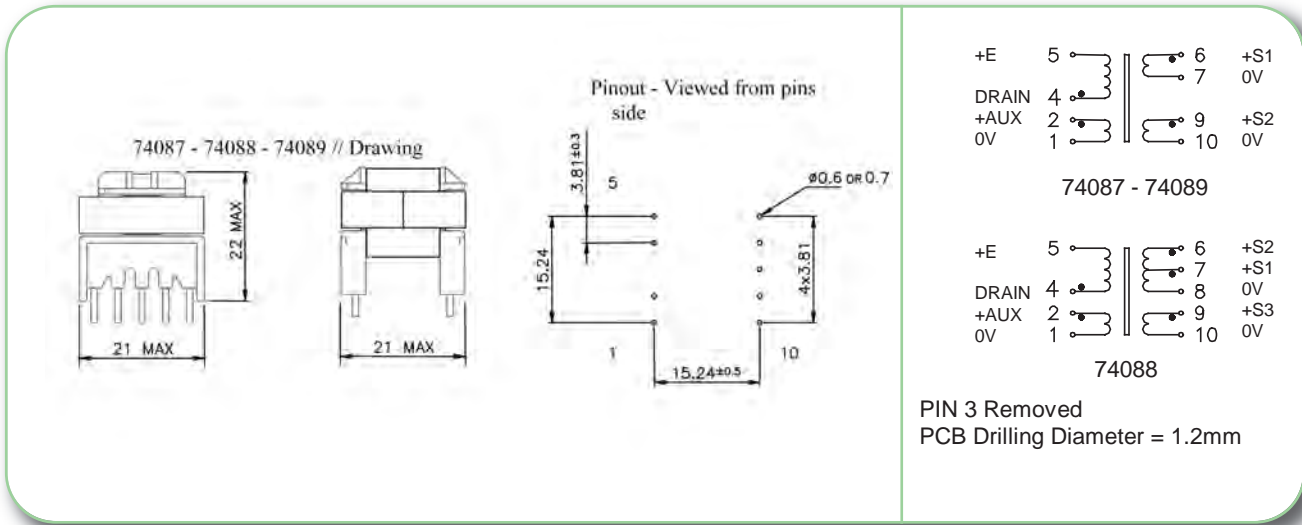

MYRRA P/N	Output Power maximum	Windings					
			Pins	Turns	Voltage	Current maximum	Inductance (+/-10%)
74087	24 w	Pri	4-5	86	85 - 265Vrms	1.0 Apeak	1000µH
		Aux	2-1	12	11 - 18 Vdc	0.3 Adc	
		S1	6-7	10	9 - 15 Vdc	1.5 Adc	
		S2	9-10	10	9 - 15 Vdc	1.5 Adc	
74088	20 w	Pri	4-5	80	85 - 265Vrms	0.9 Apeak	1100µH
		Aux	2-1	17	15 Vdc	0.3 Adc	
		S1	7-8	4	3.3 Vdc	S1 + S2 : 7 Adc	
		S2	6-8	6	5 Vdc	S1 + S2 : 7 Adc	
		S3	9-10	14	12 Vdc	1.3 Adc	
74089	20 w	Pri	4-5	86	85 - 265Vrms	0.85 Apeak	1300µH
		Aux	2-1	12	7 - 18 Vdc	0.3 Adc	
		S1	6-7	5	3 - 7.5 Vdc	2.0 Adc	
		S2	9-10	5	3 - 7.5 Vdc	2.0 Adc	

Examples of application with Integrated Circuits :

MYRRA P/N	Control IC Manufacturer	Input voltage	Power	Frequency
74087	Power Integrations	185 - 265Vrms	24w	132kHz
	Power Integrations	85 - 265Vrms	15w	132kHz
74088	Power Integrations	185 - 265Vrms	20w	132kHz
	Power Integrations	85 - 265Vrms	12w	132kHz
74089	Power Integrations	185 - 265Vrms	20w	132kHz
	Power Integrations	85 - 265Vrms	14w	132kHz
	Power Integrations	185 - 265Vrms	17w	< 120kHz



- Primary / Secondary Insulation $\geq 4000V$
- Primary / Auxiliary Insulation $\geq 1500V$
- Creepage distance Primary / Secondary $\geq 6mm$
- Ambient temperature $< 50^{\circ}C$
- Construction conforms to IEC950, IEC335, IEC61558-2-16 for reinforced insulation
- Exclusively uses UL94-V0 listed materials

MYRRA P / N	Output Power maximum	Windings					
			Pins	Turns	Voltage	Current maximum	Inductance (+/-10%)
74030	30 w	Pri	3-5	70	85 - 265Vrms	1.5 Apeak	750µH
		Aux	2-1	8	7 - 14.5 Vdc	1 Adc	
		S1	7-8	4	3.3 - 7	3 Adc	
		S2	6-8	9	8 - 16 Vdc	1.5 Adc	
		S3	9-10	9	8 - 16 Vdc	1.5 Adc	
74032	35 w	Pri	3-5	72	85 - 265Vrms	1.1 Apeak	1100µH
		Aux	2-1	10	8 - 16 Vdc	1 Adc	
		S1	6-10	18	15 - 30 Vdc	1.4 Adc	

Note for 74030 : S2 and S3 can be connected in series or in parallel

Examples of application with Integrated Circuits :

MYRRA P / N	Control IC Manufacturer	Input voltage	Power	Frequency
74030	Power Integrations	185 - 265Vrms	30w	132kHz
	Power Integrations	85 - 265Vrms	25w	66 or 132kHz
	ST Microelectronics	85 - 265Vrms	22w	70kHz
	ST Microelectronics	185 - 265Vrms	30w	70kHz
	Motorola	85 - 265Vrms	22w	100kHz
	Motorola	185 - 265Vrms	30w	100kHz
	Infineon	185 - 265Vrms	30w	100kHz
	Fairchild	85 - 265Vrms	22w	100kHz
74032	Power Integrations	185 - 265Vrms	25w	132kHz

HIGH FREQUENCY FERRITE POWER FERRITE TRANSFORMERS



- Primary / Secondary Insulation $\geq 4000V$
- Primary / Auxiliary Insulation $\geq 1500V$
- Creepage distance Primary / Secondary $\geq 8mm$
- Ambient temperature $< 50^{\circ}C$
- Construction conforms to IEC950, IEC335, IEC61558-2-16 for reinforced insulation
- Exclusively uses UL94-V0 listed materials

Bottom View (Pin side)

PIN 4 Removed
PCB Drilling Diameter = 1.3mm

MYRRA P / N	Output Power maximum	Windings					
			Pins	Turns	Voltage	Current maximum	Inductance (+/-10%)
74040	60 w	Pri	5 - 7	50	85 - 265Vrms	3.0 Apeak	500µH
		Aux	3 - 2	6	7 - 14.5 Vdc	0.5 Adc	
		S1	12 - 13	3	3.3 - 7	4 Adc	
		S2	11 - 13	7	8 - 16.5 Vdc	2.5 Adc	
		S3	9 - 10	3	3.3 - 7	4 Adc	
		S4	8 - 10	7	8 - 16.5 Vdc	2.5 Adc	

Note : S1 / S3 or S2 / S4 can be connected in series or in parallel

Examples of application with Integrated Circuits :

MYRRA P / N	Control IC Manufacturer	Input voltage	Power	Frequency
74040	Power Integrations	185 - 265Vrms	60w	66 or 132kHz
	Power Integrations	85 - 265Vrms	45w	66 or 132kHz
	ST Microelectronics	85 - 265Vrms	35w	100kHz
	ST Microelectronics	185 - 265Vrms	45w	100kHz
	Motorola	85 - 265Vrms	35w	100kHz
	Motorola	185 - 265Vrms	45w	100kHz
	Infineon	92 - 265Vrms	35w	100kHz
	Infineon	185 - 265Vrms	45w	100kHz



- Primary / Secondary Insulation $\geq 4000V$
- Primary / Auxiliary Insulation $\geq 1500V$
- Creepage distance Primary / Secondary $\geq 6mm$
- Ambient temperature $< 50^{\circ}C$
- Construction conforms to IEC950, IEC335, IEC61558-2-16 for reinforced insulation
- Exclusively uses UL94-V0 listed materials

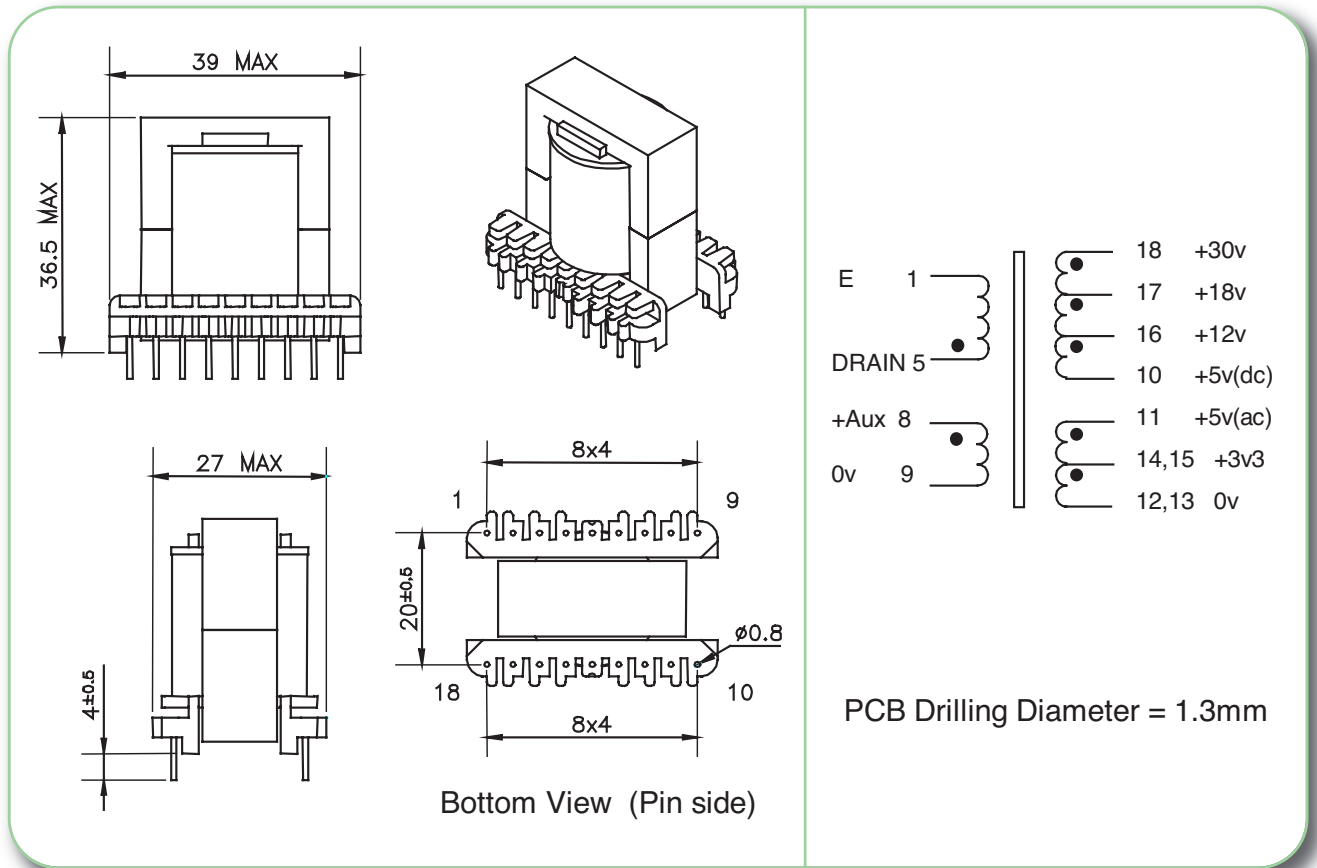

HIGH FREQUENCY FERRITE
POWER FERRITE TRANSFORMERS

MYRRA P / N	Output Power maximum	Windings					
			Pins	Turns	Voltage	Current maximum	Inductance (+/-10%)
74043	60w	Pri	5 – 1	45	85 - 265Vrms	3 Apeak	500µH
		Aux	8 – 9	7	15 Vdc	0.5 Adc	
		S1	14+15 / 12+13	2	3.3 Vdc	S1+S2 : 7 Adc	
		S2	11 / 12+13	3	5 Vdc	S1+S2 : 7 Adc	
		S3	16 – 10	4	12 Vdc	2 Adc	
		S4	17 – 10	7	18 Vdc	2 Adc	
		S5	18 – 10	13	30 Vdc	0.5 Adc	

Examples of application with Integrated Circuits :

MYRRA P / N	Control IC Manufacturer	Input voltage	Power	Frequency
74043	Power Integrations	185 - 265Vrms	60w	66 or 132kHz
	Power Integrations	85 - 265Vrms	45w	66 or 132kHz



- Primary / Secondary Insulation $\geq 4000V$
- Primary / Auxiliary Insulation $\geq 1500V$
- Creepage distance Primary / Secondary $\geq 8mm$
- Ambient temperature $< 50^{\circ}C$
- Construction conforms to IEC950, IEC335, IEC61558-2-16 for reinforced insulation
- Exclusively uses UL94-V0 listed materials

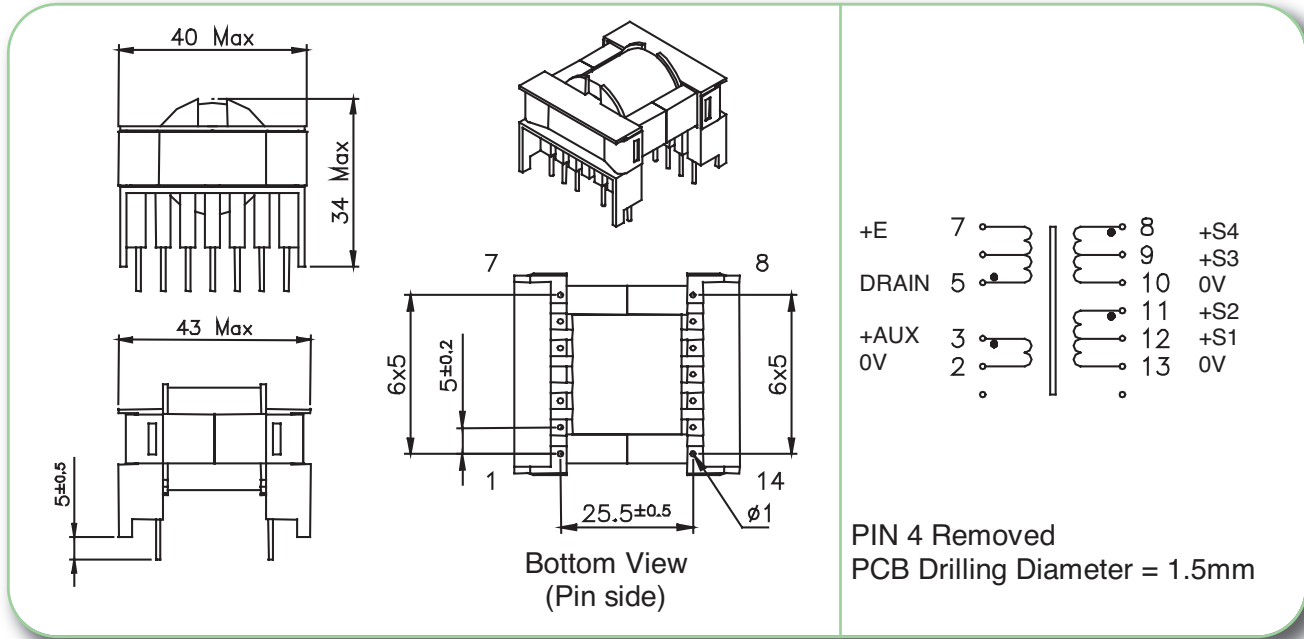

MYRRA P / N	Output Power maximum	Windings					
			Pins	Turns	Voltage	Current maximum	Inductance (+/-10%)
74050	90 w	Pri	5 - 7	36	85 - 265Vrms	2.8 Apeak	500µH
		Aux	3 - 2	4	7 - 14 Vdc	0.5 Adc	
		S1	12 - 13	2	3.3 - 6.5	5 Adc	
		S2	11 - 13	5	8.5 - 17 Vdc	3 Adc	
		S3	9 - 10	2	3.3 - 6.5	5 Adc	
		S4	8 - 10	5	8.5 - 17 Vdc	3 Adc	

Note : S1 / S3 or S2 / S4 can be connected in series or in parallel

Examples of application with Integrated Circuits :

MYRRA P / N	Control IC Manufacturer	Input voltage	Power	Frequency
74050	Power Integrations	185 - 265Vrms	90w	132kHz
	Power Integrations	85 - 265Vrms	60w	66 or 132kHz
	ST Microelectronics	185 - 265Vrms	80w	70kHz
	ST Microelectronics	85 - 265Vrms	60w	70kHz
	Motorola	185 - 265Vrms	80w	100kHz
	Motorola	85 - 265Vrms	60w	100kHz
	Infineon	185 - 265Vrms	80w	100kHz
	Infineon	85 - 265Vrms	60w	100kHz



- Primary / Secondary Insulation $\geq 4000V$
- Primary / Auxiliary Insulation $\geq 1500V$
- Creepage distance Primary / Secondary $\geq 8mm$
- Ambient temperature $< 50^{\circ}C$
- Construction conforms to IEC950, IEC335, IEC61558-2-16 for reinforced insulation
- Exclusively uses UL94-V0 listed materials

Bottom View (Pin side)

PIN 4 Removed
PCB Drilling Diameter = 1.5mm

MYRRA P / N	Output Power maximum	Windings					
			Pins	Turns	Voltage	Current maximum	Inductance (+/-10%)
74060	140 w	Pri	5 – 7	36	85 - 265Vrms	4 Apeak	440µH
		Aux	3 – 2	4	7 – 14 Vdc	0.5 A dc	
		S1	14 – 15	2	3.3 – 6.5	5 A dc	
		S2	13 – 15	5	8.5 – 17 Vdc	5 A dc	
		S3	11 – 12	2	3.3 – 6.5	5 A dc	
		S4	10 – 12	5	8.5 – 17 Vdc	5 A dc	

Note : S1 / S3 or S2 / S4 can be connected in series or in parallel

Examples of application with Integrated Circuits :

MYRRA P / N	Control IC Manufacturer	Input voltage	Power	Frequency
74060	Power Integrations	185 - 265Vrms	140w	132kHz
	Power Integrations	85 - 265Vrms	90w	66 or 132kHz
	ST Microelectronics	85 - 265Vrms	70w	70kHz
	ST Microelectronics	185 - 265Vrms	120w	100kHz
	Motorola	85 - 265Vrms	70w	100kHz
	Motorola	185 - 265Vrms	120w	100kHz
	Infineon	85 - 265Vrms	70w	100kHz
	Infineon	185 - 265Vrms	120w	100kHz
	Fairchild	85 - 265Vrms	70w	100kHz
Fairchild	185 - 265Vrms	120w	100kHz	

HIGH FREQUENCY FERRITE
POWER FERRITE TRANSFORMERS



- Primary / Secondary Insulation $\geq 4000V$
- Primary / Auxiliary Insulation $\geq 1500V$
- Creepage distance Primary / Secondary $\geq 8mm$
- Ambient temperature $< 50^{\circ}C$
- Construction conforms to IEC950, IEC335, IEC61558-2-16 for reinforced insulation
- Exclusively uses UL94-V0 listed materials

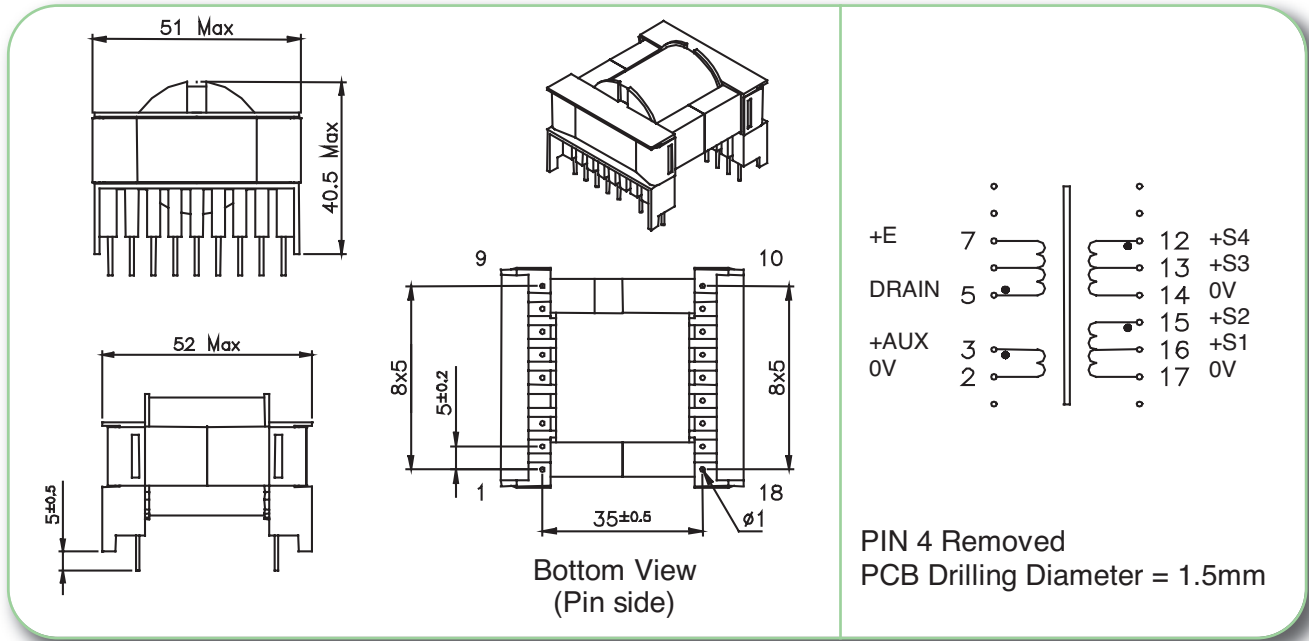

MYRRA P / N	Output Power maximum	Windings					
			Pins	Turns	Voltage	Current maximum	Inductance (+/-10%)
74070	180 w	Pri	5 – 7	38	85 - 265Vrms	8 Apeak	300μH
		Aux	3 – 2	4	7 – 14 Vdc	0.5 Adc	
		S1	16 – 17	2	3.3 – 6.5	6 Adc	
		S2	15 – 17	5	8.5 – 17 Vdc	5 Adc	
		S3	13 – 14	2	3.3 – 6.5	6 Adc	
		S4	12 – 14	5	8.5 – 17 Vdc	5 Adc	

Note : S1 / S3 or S2 / S4 can be connected in series or in parallel

Examples of application with Integrated Circuits :

MYRRA P / N	Control IC Manufacturer	Input voltage	Power	Frequency
74070	Power Integrations	185 - 265Vrms	180w	66 or 132kHz
	Power Integrations	85 - 265Vrms	120w	66kHz
	Infineon	185 - 265Vrms	160w	100kHz
	Fairchild	185 - 265Vrms	160w	100kHz
	Philips	185 - 265Vrms	120w	50kHz

HIGH FREQUENCY FERRITE
POWER FERRITE TRANSFORMERS



1W

2W

3W

4W

5W

8W

12W

15W

20W

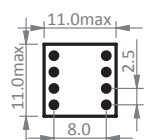
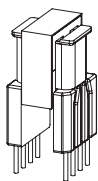

Height : 19.0mm max

E 10
reinforced insulation
creepage distances: 6mm

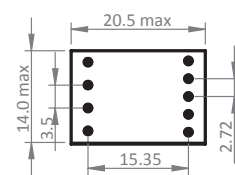
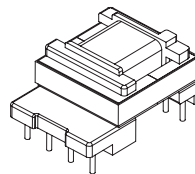

Height : 11mm max

EF 12.6
reinforced insulation
creepage distances: 6mm

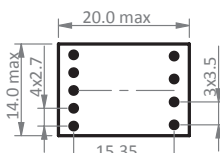
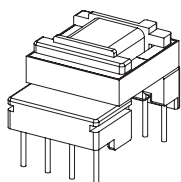

Height : 12.5mm max

EF 12.6
reinforced insulation
creepage distances: 6mm

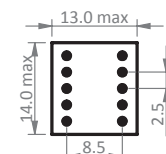
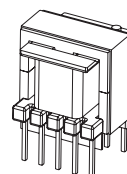

Height : 14.8mm max

E 13
basic insulation

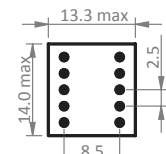
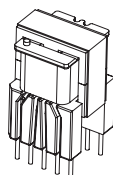

Height : 19.2mm max

E 13
reinforced insulation
creepage distances: 6mm

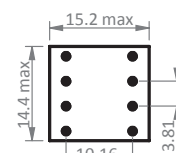
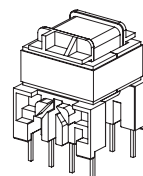

Height : 17.7mm max

E 13
reinforced insulation
creepage distances: 6mm

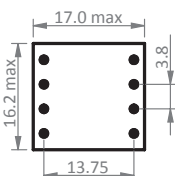
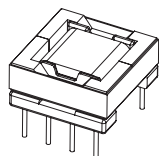

Height : 11mm max

EFD 15
basic insulation

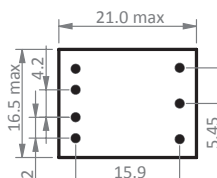
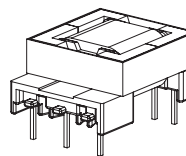

Height : 10.0mm max

EFD 15
reinforced insulation
creepage distances: 6mm

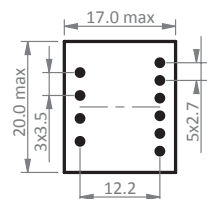
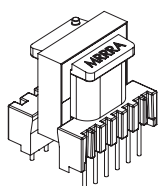

Height : 21.0 mm max

E 16
reinforced insulation
creepage distances: 6mm

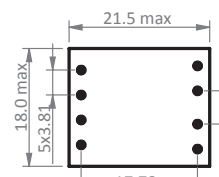
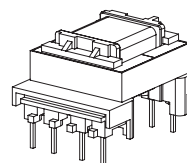

Height : 14.0mm max

EF 16
reinforced insulation
creepage distances: 6mm

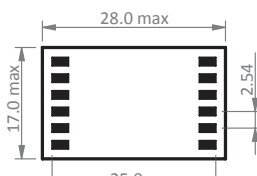
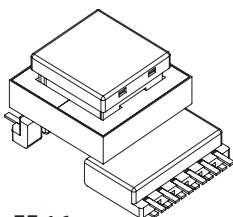

Height : 14.7mm max

EF 16
reinforced insulation
creepage distances: 6mm

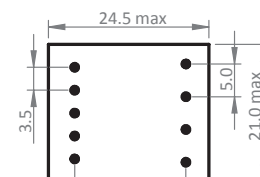
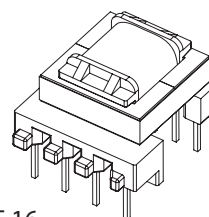

Height : 17mm max

EF 16
reinforced insulation
creepage distances: 6mm

HIGH FREQUENCY FERRITE
POWER FERRITE TRANSFORMERS

*non-exhaustive list



20W

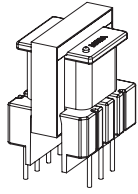

E 19
reinforced insulation
creepage distances: 6mm

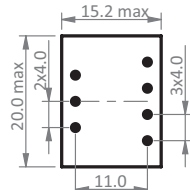

Height : 23.5mm max

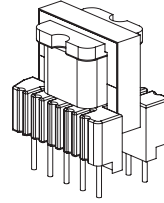

E 19
reinforced insulation
creepage distances: 6mm

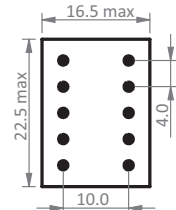

Height : 23.5mm max

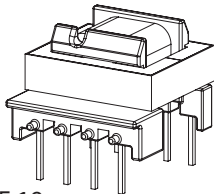

E 19
reinforced insulation
creepage distances: 6mm

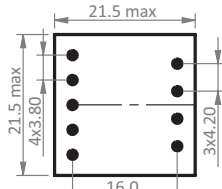

Height : 15.0mm max

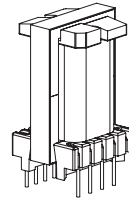

EL 19
reinforced insulation
creepage distances: 6mm

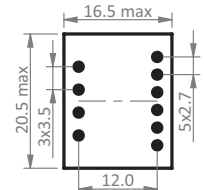

Height : 31.0mm max

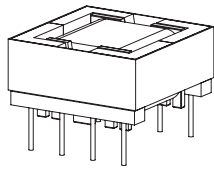

EFD 20
basic insulation

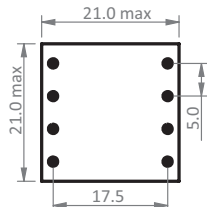

Height : 11.0mm max

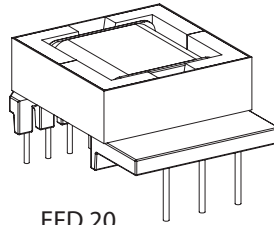

EFD 20
reinforced insulation
creepage distances: 6mm

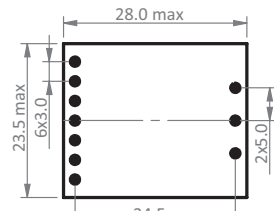

Height : 11.5mm max

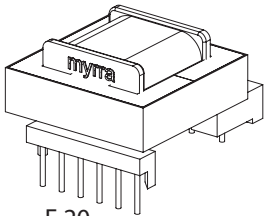

E 20
reinforced insulation
creepage distances: 6mm

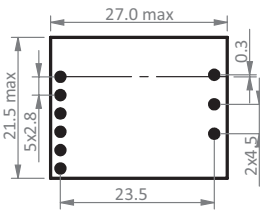

Height : 13.0mm max

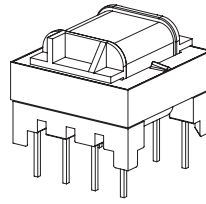

EF 20
basic insulation

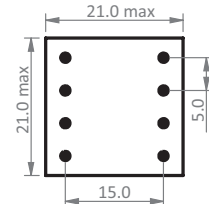

Height : 16.0mm max

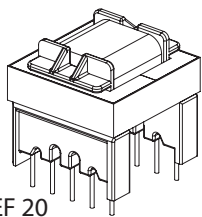

EF 20
reinforced insulation
creepage distances: 6mm

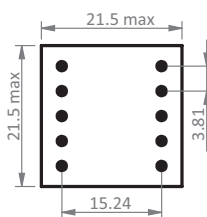

Height : 21.0mm max

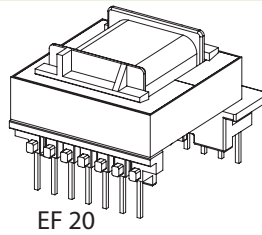

EF 20
reinforced insulation
creepage distances: 8mm

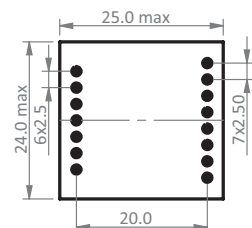

Height : 16.0mm max

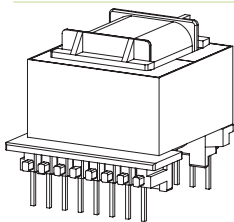

EF 20/11
reinforced insulation
creepage distances: 6mm

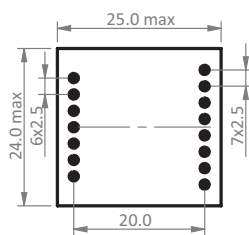

Height : 22.0mm max

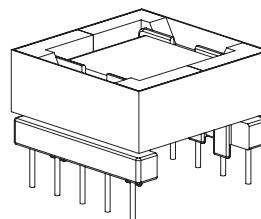

EFD 25
basic insulation

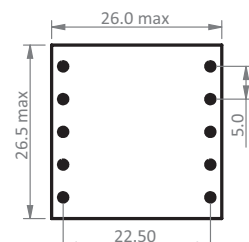

Height : 16.0mm max

HIGH FREQUENCY FERRITE
POWER FERRITE TRANSFORMERS

*non-exhaustive list

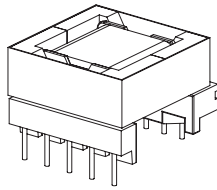

EFD 25
reinforced insulation
creepage distances: 6mm

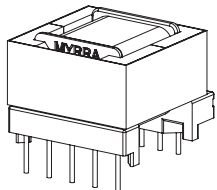
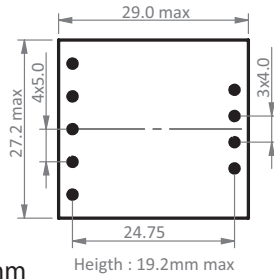

EVD 25
reinforced insulation
creepage distances: 6mm

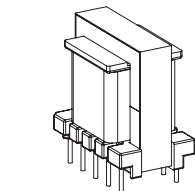
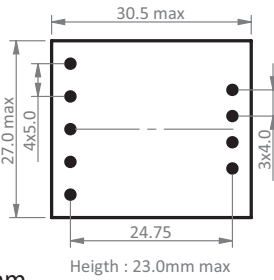

EF 25
reinforced insulation
creepage distances: 6mm

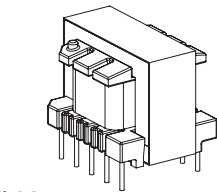
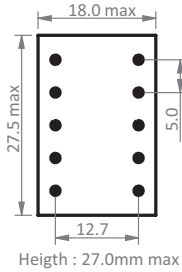

EI 28
reinforced insulation
creepage distances: 6mm

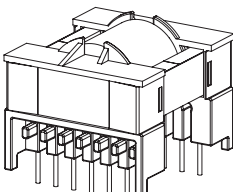
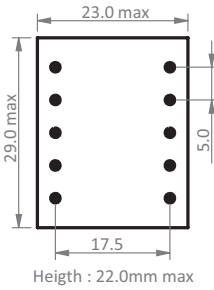

ETD Horizontal
reinforced insulation
creepage distances: 6mm

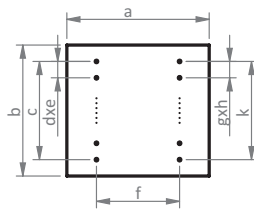

unit:mm

Size	Pin Qty.	a (max)	b (max)	c	dx	e	gx	h	k	height (max)
ETD29	7+7	36.5	36.5	30.48	6x5.08	25.4	6x5.08	30.48	25.5	
ETD34	7+7	43.0	41.0	30.0	6x5.0	25.5	6x5.0	30.0	34.5	
ETD39	8+8	45.0	45.0	35.0	7x5.0	30.2	7x5.0	35.0	34.0	
ETD44	9+9	52.5	50.0	40.0	8x5.0	35.56	8x5.0	40.0	40.0	
ETD49	10+10	58.0	57.0	45.0	9x5.0	40.8	9x5.0	45.0	43.5	

50W

100W

200W

500W

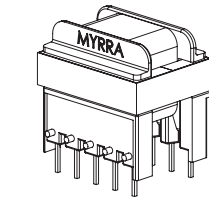

E 25
reinforced insulation
creepage distances: 8mm

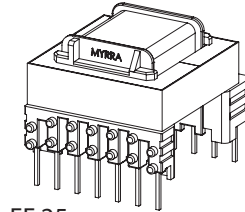
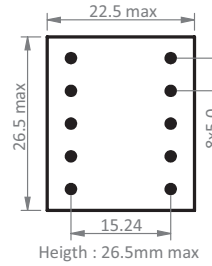

EF 25
reinforced insulation
creepage distances: 8mm

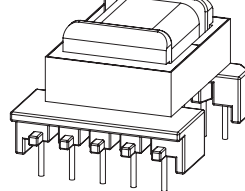
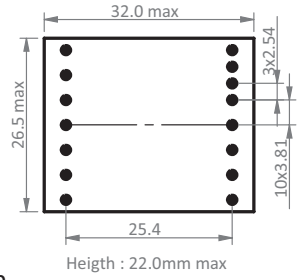

EF 25
reinforced insulation
creepage distances: 6mm

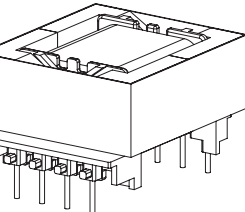
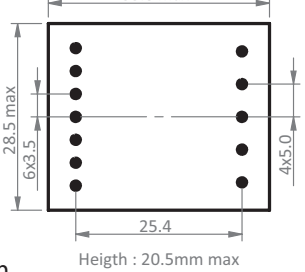

EVD 30
reinforced insulation
creepage distances: 6mm

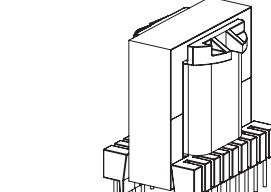
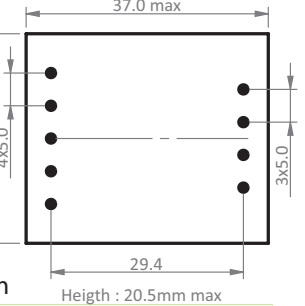

ETD Vertical
reinforced insulation
creepage distances: 6mm

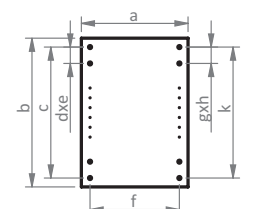

unit:mm

Size	Pin Qty.	a (max)	b (max)	c	dx	e	gx	h	k	height (max)
ETD29	7+7	25.0	35.5	30.48	6x5.08	20.32	6x5.08	30.48	41.5	
ETD34	7+7	28.0	35.5	30.48	6x5.08	22.85	6x5.08	30.48	35.5	
ETD39	8+8	31.5	41.0	35.0	7x5.0	25.4	7x5.0	35.0	47.0	
ETD44	9+9	33.5	46.0	40.0	8x5.0	27.5	8x5.0	40.0	51.0	
ETD49	11+11	50.0	68.2	50.8	10x5.08	33.02	10x5.08	50.8	72.5	

HIGH FREQUENCY FERRITE

POWER FERRITE TRANSFORMERS

*non-exhaustive list

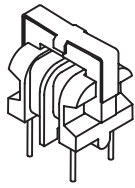

U9.8

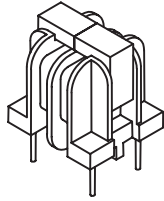

U10.5

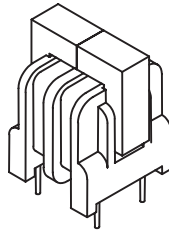

U16

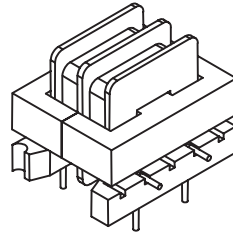

E25

- Mainly used to reduce noise conducted through power or signal lines.
- The common mode inductance filters symmetrical noise, associated with Y-type safety capacitors connected to ground.
- The differential mode inductance filters asymmetrical noise, associated with X-type capacitor connected between Line and Neutral.

MYRRA Part N°	SIZE	Inductance range	Current range
74330 - 74339	U9.8	1.5 to 47mH	0.18 to 1.1A
74300 - 74306	U10.5	1.5 to 68mH	0.30 to 1.9A
74310 - 74315	U16	1.5 to 33mH	0.75 to 3.3A
74320 - 74325	E25	1.5 to 33mH	0.90 to 4.0A

- **Toroidal Common Mode Chokes - Custom design available upon request**

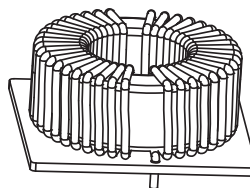
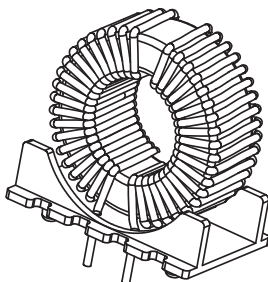



- Ambient Temperature $\leq 50^{\circ}\text{C}$
- Dielectric Strength $\geq 1.5\text{ kV}$ between windings
- Electrical characteristics at 25°C

SIZE : U10.5

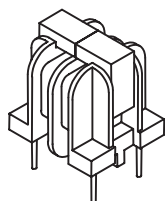

ELECTRICAL CHARACTERISTICS :

MYRRA Part N°	Inductance Common Mode min - max (mH)	Rated Current Arms	Resistance per winding ohm max	Inductance Differential Mode μH min	Resonant Frequency kHz min
74306	51 - 85	0.3	4	530	125
74300	33 - 56	0,35	3	400	170
74301	18 - 31	0,45	1,7	240	220
74302	10 - 17	0,6	1	140	320
74303	4.7 - 8	0,9	0,43	65	480
74304	2.2 - 3.7	1,3	0,23	32	740
74305	1 - 1.7	1,9	0,1	14	1000

MECHANICAL CHARACTERISTICS / PINOUT :

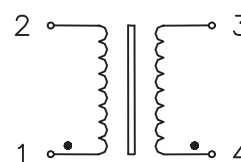
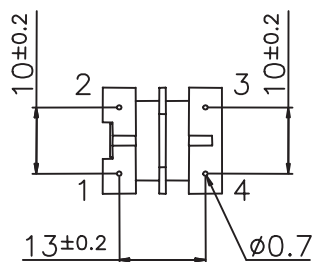
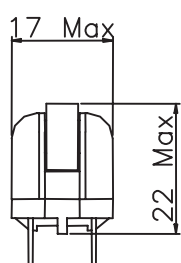
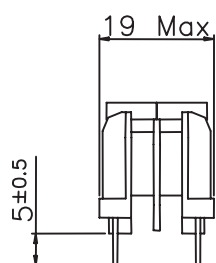

View from pin side
PCB Drilling diameter 1.1 mm

HIGH FREQUENCY FERRITE
CURRENT TRANSFORMERS RANGE



- Ambient Temperature $\leq 50^{\circ}\text{C}$
- Dielectric Strength $\geq 1.5\text{ kV}$ between windings
- Electrical characteristics at 25°C

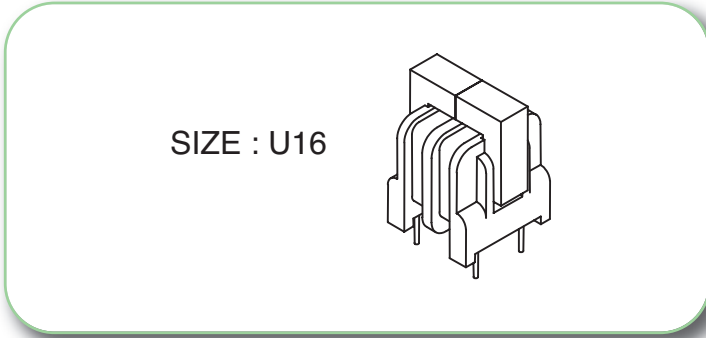

ELECTRICAL CHARACTERISTICS :

MYRRA Part N°	Inductance Common Mode min - max (mH)	Rated Current Arms	Resistance per winding ohm max	Inductance Differential Mode μH min	Resonant Frequency kHz min
74310	22 - 37	0,75	1	230	170
74311	15 - 25	0,9	0,75	150	210
74312	10 - 17	1,1	0,44	100	280
74313	4.7 - 8	1,5	0,24	50	440
74314	2.2 - 3.7	2,3	0,095	20	650
74315	1 - 1.7	3,3	0,046	10	1000

MECHANICAL CHARACTERISTICS / PINOUT :

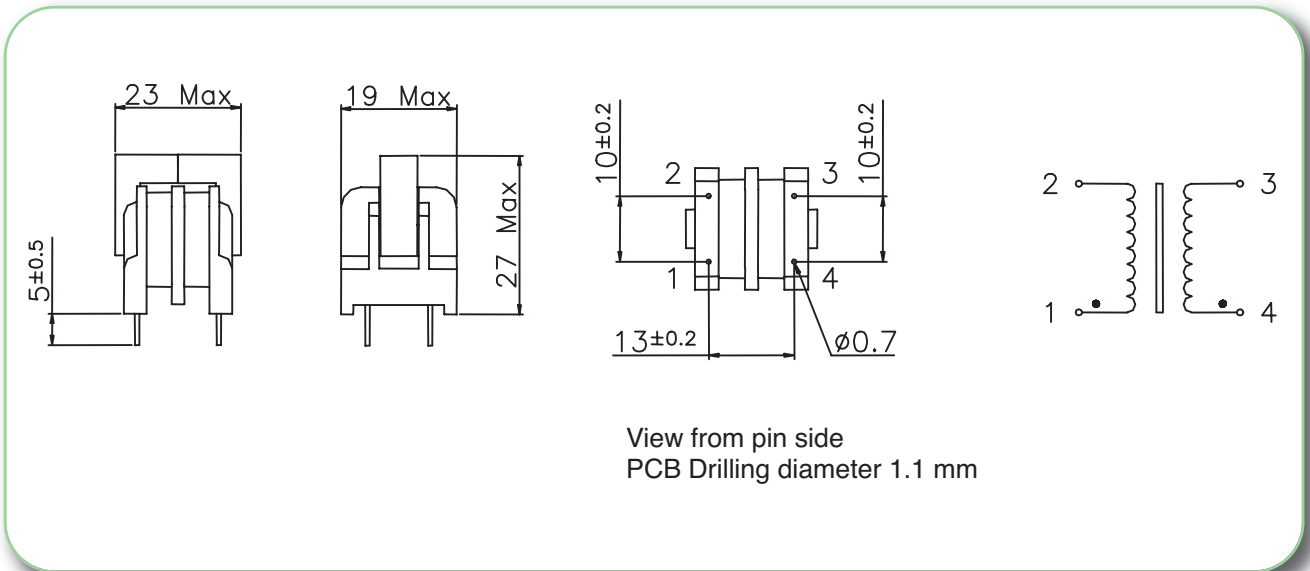

HIGH FREQUENCY FERRITE
CURRENT TRANSFORMERS RANGE



- Ambient Temperature $\leq 50^{\circ}\text{C}$
- Dielectric Strength $\geq 1.5\text{ kV}$ between windings
- Electrical characteristics at 25°C

SIZE : E25

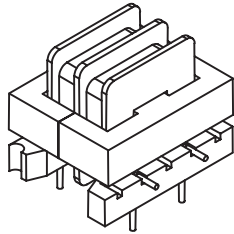

ELECTRICAL CHARACTERISTICS :

MYRRA Part N°	Inductance Common Mode min - max (mH)	Rated Current Arms	Resistance per winding ohm max	Inductance Differential Mode μH min	Resonant Frequency kHz min
74320	22 – 37	0,9	0,54	130	170
74321	15 – 25	1,1	0,35	90	210
74322	10 - 17	1,3	0,22	50	270
74323	4.7 - 8	1,8	0,105	25	400
74324	2.2 - 3.7	2,7	0,05	11	630
74325	1 - 1.7	4	0,03	7	950

MECHANICAL CHARACTERISTICS / PINOUT :

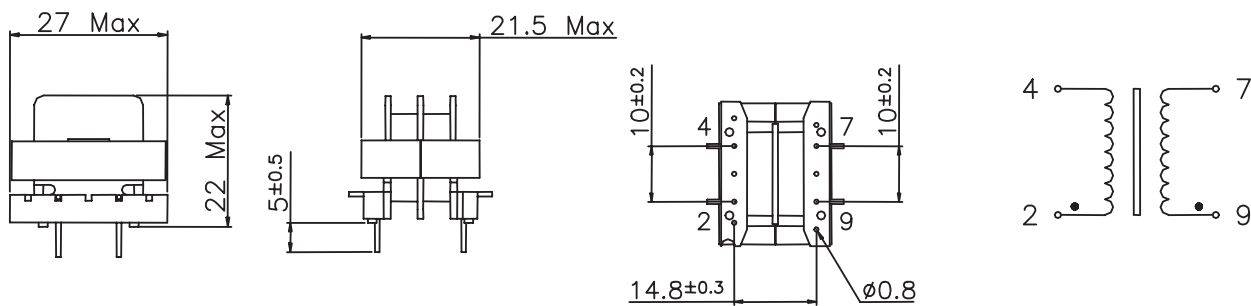

View from pin side
PCB Drilling diameter 1.2 mm

HIGH FREQUENCY FERRITE
CURRENT TRANSFORMERS RANGE



- For noise suppression in light dimmers
- Saturable chokes : provides a high impedance for Triac switching interferences, and a low impedance for 50Hz component.
- Electrical characteristics at 25 °

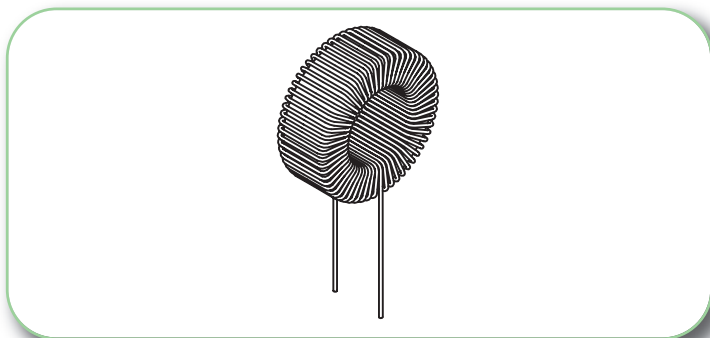

ELECTRICAL CHARACTERISTICS :

MYRRA Part N°	Power	Inductance +/- 15 %	Rated Current	Resistance	Associated Capacitor	Dimensions (mm)				Approx. Weight
						OD max	ID min	H max	W max	
74190	150 w	3.5 mH	0.7 Arms	1.5 Ω	22 nF	24	9	9.5	0.5	13 g
74191	300 w	2.8 mH	1.3 Arms	0.73 Ω	47 nF	29	10	12	0.7	24 g
74192	500 w	2.0 mH	2.2 Arms	0.35 Ω	82 nF	32.5	9	16	0.9	47 g
74196	500 w	1.8 mH	2.2 Arms	0.37 Ω	82 nF	38	14	12	0.9	39 g
74193	1000 w	1.3 mH	4.5 Arms	0.15 Ω	220 nF	44	14	16.5	1.2	80 g
74194	2200 w	450 μH	10 Arms	0.04 Ω	470 nF	50	12	22.5	1.8	140 g
74195	4500 w	250 μH	20 Arms	0.014 Ω	1 μF	58	10	28	2.5	250 g

MECHANICAL CHARACTERISTICS :

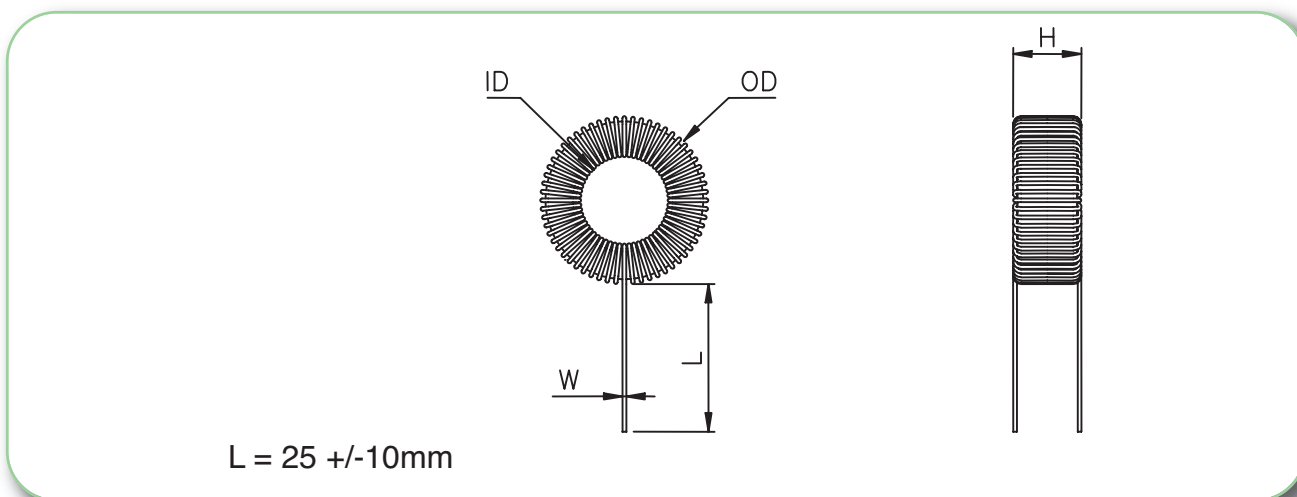

HIGH FREQUENCY FERRITE TOROIDAL CHOKES

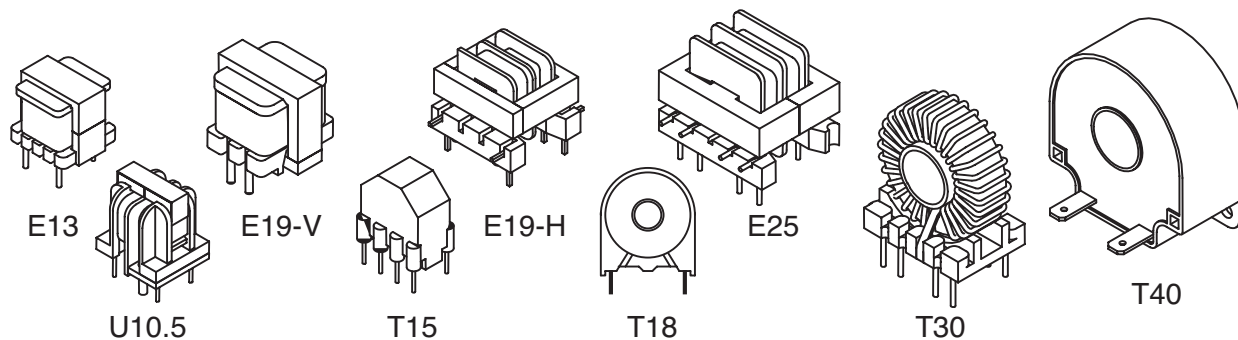

• FOR MAINS AC CURRENT MEASUREMENT - 50 to 400 Hz

MYRRA Part N°	SIZE	Ratio	Current range
PIN PRIMARY - up to 25A			
74521	Size E19-H	Ratio 1 / 1 / 750	Current 10 A / 20 A
74523	Size E19-V	Ratio 1 / 500	Current 15 A
74531	Size E25	Ratio 1 / 1 / 1000	Current 12.5 A / 25 A
74533	Size E25	Ratio 1 / 1000	Current 8 A
74534	Size E25	Ratio 1 / 350	Current 4 A
74561	Size U10.5	Ratio 1 / 2000	Current 8 A
THRU-HOLE PRIMARY - up to 250A			
74503	Size T18	Ratio 1 / 1000	Current 12 A
74504	Size T18	Ratio 1 / 750	Current 10 A
74511	Size T30	Ratio 1 / 1000	Current 60 A
74543, 74544, 74545	Size T40	Ratio 1 / 500	Current 100 A
74546, 74547, 74548	Size T40	Ratio 1 / 1000	Current 250 A

• FOR SWITCH MODE POWER SUPPLIES - 20 to 150kHz

MYRRA Part N°	SIZE	Ratio	Current range
PIN PRIMARY - up to 25A			
74520	Size E19-H	Ratio 1 / 1 / 100	Current 10 A / 20 A
74530	Size E25	Ratio 1 / 1 / 100	Current 12.5 A / 25 A
74550	Size E13	Ratio 1 / 100	Current 10 A
74560	Size U10.5	Ratio 1 / 100	Current 10 A
74562	Size U10.5	Ratio 1 / 100	Current 10 A
74570	Size T15	Ratio 1 / 1 / 50	Current 10 A / 20 A
THRU-HOLE PRIMARY - up to 200A			
74500	Size T18	Ratio 1 / 50	Current 15 A
74501	Size T18	Ratio 1 / 100	Current 25 A
74502	Size T18	Ratio 1 / 200	Current 25 A
74510	Size T30	Ratio 1 / 100	Current 150 A
74540, 74541, 74542	Size T40	Ratio 1 / 100	Current 200 A

HIGH FREQUENCY FERRITE
CURRENT TRANSFORMERS RANGE

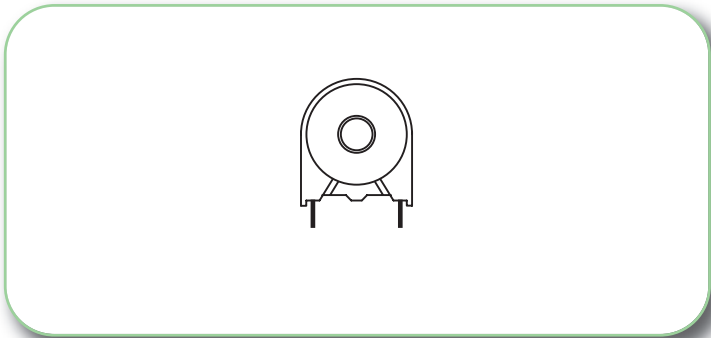

MYRRA Part N°	Sec. Turns	Max Pri. Current A rms	Rsec. Ω max	Lsec. mH min	Pulse Vsec x t max @ Frequency	Sine Vsec max @ Frequency	Typical Load/ Accuracy/ Current
74500	50	15 A	0.6 Ω	5	175 V μ S 20 – 200 kHz	15 V 20 – 200 kHz	50 Ω / 1% / 15 A
74501	100	25 A	1.5 Ω	20	350 V μ S 20 – 100 kHz	25 V 20 – 100 kHz	100 Ω / 1% / 25 A
74502	200	25 A	5 Ω	80	700 V μ S 20 – 100 kHz	50 V 20 – 100 kHz	200 Ω / 1% / 25 A
74503	1000	12 A	45 Ω	2000	2.5 V.ms 50 Hz	0.15V/ 50 Hz/ 12A 0.6V/ 50 Hz/ 8A	$\leq 10 \Omega$ / 2% / 12 A $\leq 40 \Omega$ / 2% / 8 A
74504	750	10 A	35 Ω	1100	2.0 V.ms 50 Hz	0.13V/ 50 Hz/ 10A 0.3V/ 50 Hz/ 5A	$\leq 10 \Omega$ / 2% / 10 A $\leq 40 \Omega$ / 2% / 5 A

Data applies for one primary turn (single passage of primary wire through toroid hole). Sensitivity can be increased for lower currents by winding more than one turn.

HIGH FREQUENCY FERRITE
CURRENT TRANSFORMERS RANGE

74500 / 74501 / 74502
74503 / 74504

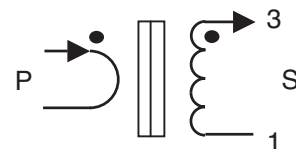
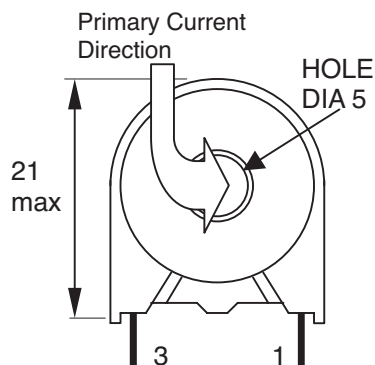
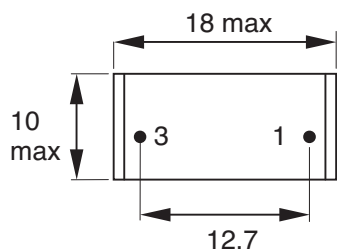

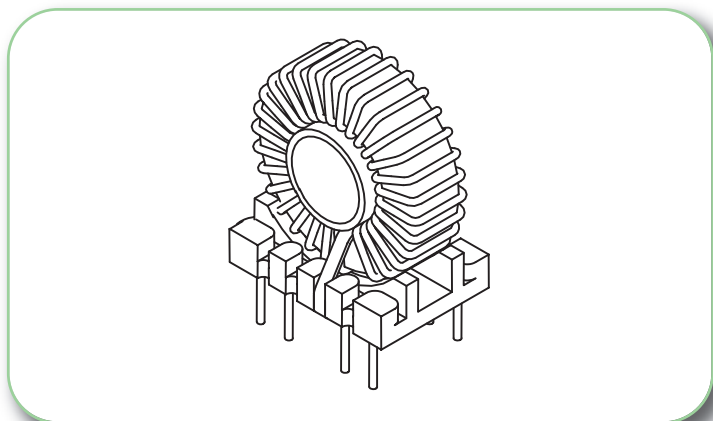

MYRRA Part N°	Sec. Turns	Max Pri. Current Arms	Rsec. Ω max	Lsec. mH min	Pulse Vsec x t max @ Frequency	Sine Vsec max @ Frequency	Typical Load/Accuracy/ Current
74510	100	150 A	0.25 Ω	40	1 V.ms/ 20 kHz 700 V μ s/ 100 kHz	50 V/ 20 kHz 80 V/ 100 kHz	1 - 20 Ω / 1%
74511	1000	60 A	32 Ω	4000	10 V.ms/ 50 Hz	0.6 V/ 50 Hz/ 60 A 1 V/ 50 Hz/ 40 A	\leq 10 Ω / 1% / 60 A \leq 20 Ω / 1% / 40 A

Data applies for one primary turn (single passage of primary wire through toroid hole).

Sensitivity can be increased for lower currents by winding more than one turn.

Models with 50, 100, 200 turns are designed for switch-mode power conversion

(up to 200 kHz).

Models with 500 and 1000 turns are designed for Mains current measurement (50 to 400 Hz).

74510/ 74511

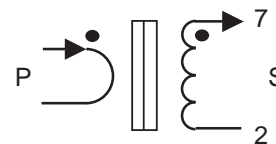
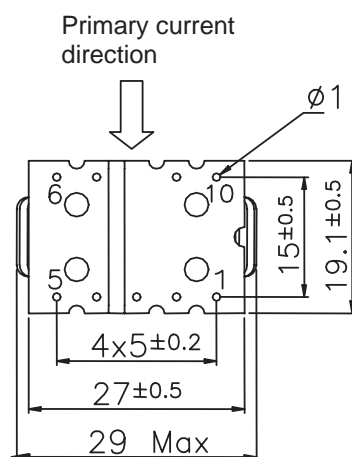
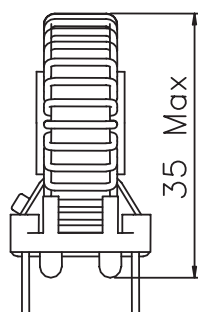
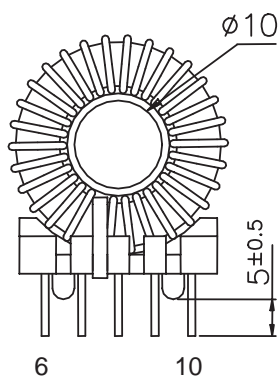

Pin 8 removed for locating

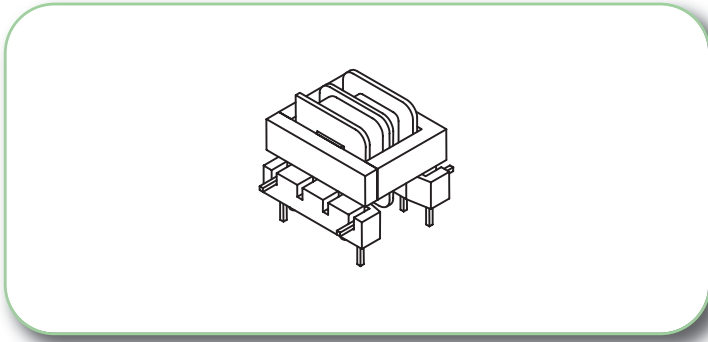

FOR SWITCH MODE POWER SUPPLIES - 20 to 150 kHz								
MYRRA Part N°	Ratio	Max Pri. Current A rms	Rsec. Ω max	Lsec. mH min	Pulse Vsec x t max	Sine Vsec rms max	Typical Load/ Accuracy/ Current	Insulation Voltage P/S
74520	1/1/100	20 A parallel 10 A serie	1.5	8	400 V.µs	50 Vrms	10 – 100 Ω / 1% / 10 A	2500 V

FOR MAINS AC CURRENT MEASUREMENT - 50 to 400 Hz								
MYRRA Part N°	Ratio	Max Pri. Current A rms	Rsec. Ω max	Lsec. mH min	Pulse Vsec x t max	Sine Vsec rms max	Typical Load/ Accuracy/ Current	Insulation Voltage P/S
74521	1/1/750	20 A parallel 10 A serie	57	300	15 V.ms	3 Vrms	≤ 75 Ω / 4% / 20 A	2500 V

SAFETY :

These products are only composed of UL approved materials.
 These products have a construction conform to CEI950, CEI335, CEI61558 for Basic insulation (3 mm creepage distance)

HIGH FREQUENCY FERRITE
CURRENT TRANSFORMERS RANGE

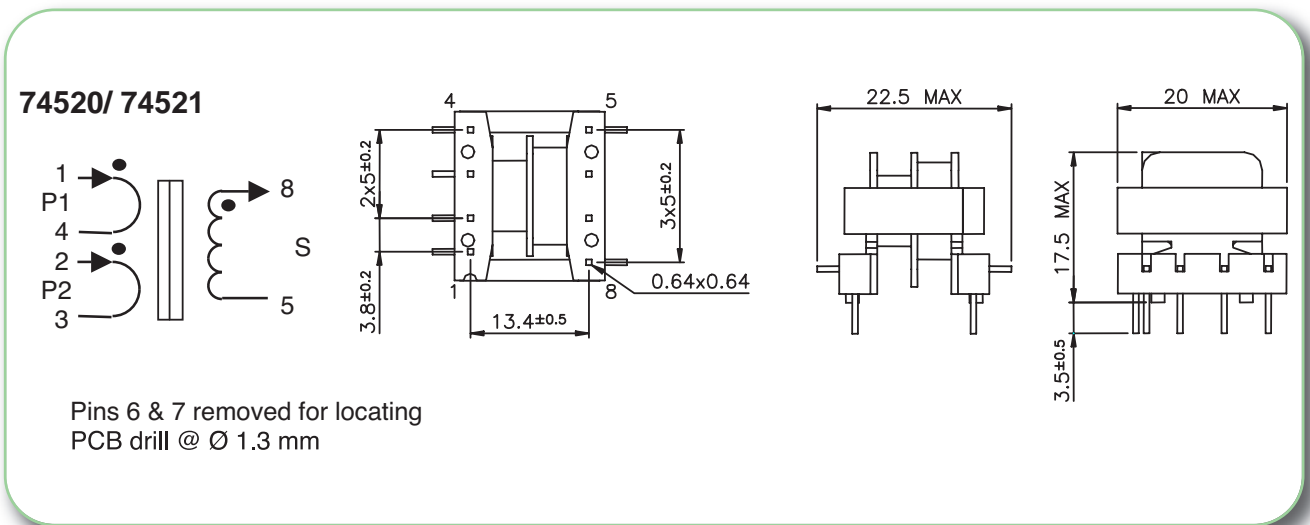

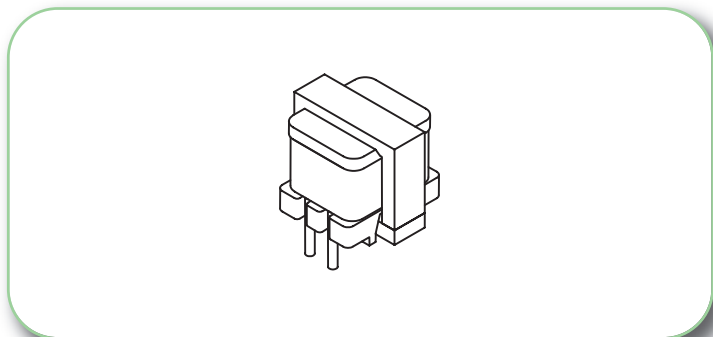

FOR MAINS AC CURRENT MEASUREMENT - 50 to 400 Hz

MYRRA Part N°	Ratio	Max Pri. Current A rms	Rsec. Ω max	Lsec. mH min	Pulse Vsec x t max	Sine Vsec rms max	Typical Load/ Accuracy/ Current	Insulation Voltage P/ S
74523	1/ 500	15 A	155	670	30 V.ms	6 Vrms	≤ 50 Ω / 2% / 15 A ≤ 200 Ω / 5% / 10 A	1500 V

SAFETY :

This product is only composed of UL approved materials.

This product has a construction conform to CEI950, CEI335, CEI61558 for Functional insulation

74523

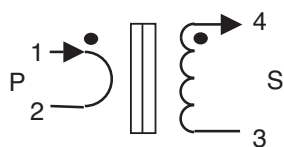

Pins 6 & 7 removed for locating PCB drill @ Ø 1.2 & 1.8 mm

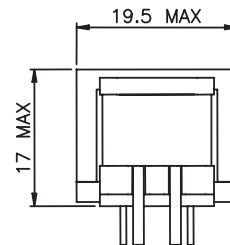
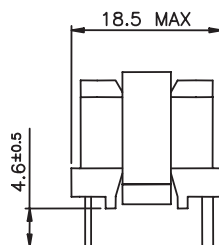
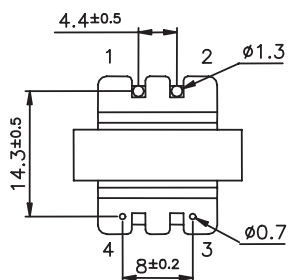

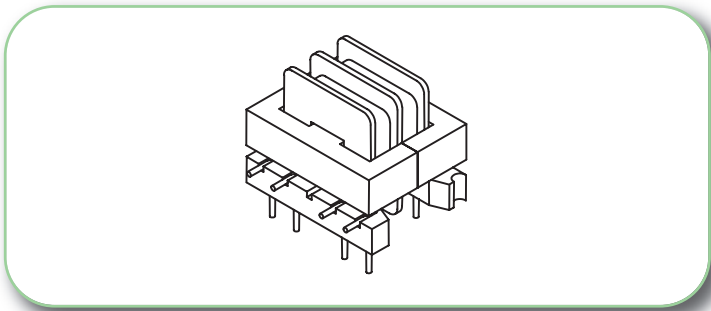

FOR SWITCH MODE POWER SUPPLIES - 20 to 150 kHz								
MYRRA Part N°	Ratio	Max Pri. Current A rms	Rsec. Ω max	Lsec. mH min	Pulse Vsec x t max	Sine Vsec rms max	Typical Load/ Accuracy/ Current	Insulation Voltage P/S
74530	1/1/100	25 A parallel 12.5 A serie	1	10	600 V.µs	80 Vrms	10 - 100 Ω / 1% / 25 A	2500 V

FOR MAINS AC CURRENT MEASUREMENT - 50 to 400 Hz								
MYRRA Part N°	Ratio	Max Pri. Current A rms	Rsec. Ω max	Lsec. mH min	Pulse Vsec x t max	Sine Vsec rms max	Typical Load/ Accuracy/ Current	Insulation Voltage P/S
74531	1/1/1000	25 A parallel 12.5 A serie	90	4 H	8 V.ms	1.6 Vrms	≤ 50 Ω / 2% / 20 A	2500 V
74533	1/ 1000	8 A	360	17 H	15 V.ms	3 Vrms	≤ 200 Ω / 1% / 8 A ≤ 500 Ω / 1.5% / 5 A	2500 V
74534	1/350	4 A	380	19 H	15 V.ms	3 Vrms	≤ 100 Ω / 1% / 4 A ≤ 500 Ω / 1% / 2 A	2500 V

SAFETY :

These products are only composed of UL approved materials.

These products have a construction conform to CEI950, CEI335, CEI61558 for Basic insulation (3 mm creepage distance)

HIGH FREQUENCY FERRITE
CURRENT TRANSFORMERS RANGE

74530/ 74531

74533/ 74534

Pins 1 & 8 removed for locating PCB drill @ Ø 1.3mm

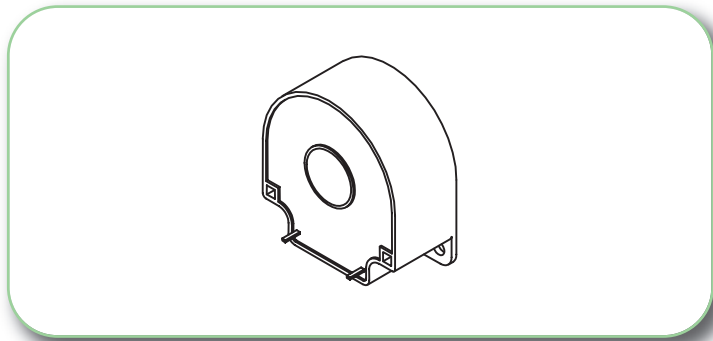

MYRRA Part N°	Sec. Turns	Max Pri. Current A rms	Rsec. Ω max	Lsec. mH min	Pulse Vsec x t max @ Frequency	Sine Vsec max @ Frequency	Typical Load/ Accuracy/ Current
74540	100	200 A	0.35 Ω	50	2 V.ms/ 20 kHz 1 V.ms/ 100 kHz	150 V/ 20 kHz 150 V/ 100 kHz	1..20 Ω / 1%
74543	500	100 A	6.5 Ω	1250	10 V.ms/ 50 Hz	0.7 V/ 50Hz/ 100 A 1.2 V/ 50Hz/ 60 A	≤ 3 Ω / 1% / 100 A ≤ 10 Ω / 1% / 60 A
74546	1000	250 A	22 Ω	8000	100 V.ms/ 50 Hz	15 V/ 50 Hz/ 250 A	≤ 50 Ω / 1% / 250 A

Data applies for one primary turn (single passage of primary wire through toroid hole).
Sensitivity can be increased for lower currents by winding more than one turn.

74540/ 74543/ 74546 Pin type (for PCB) □ 0.6 x 0.95

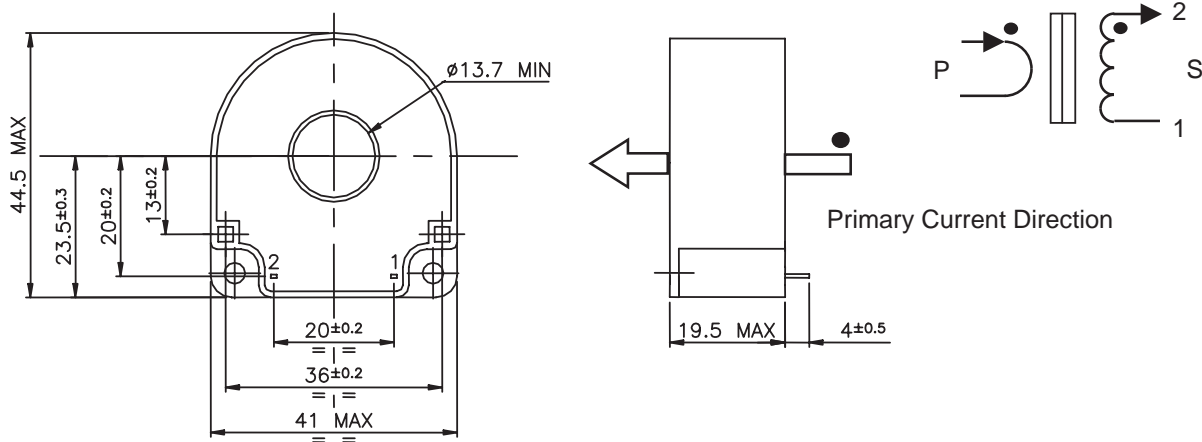

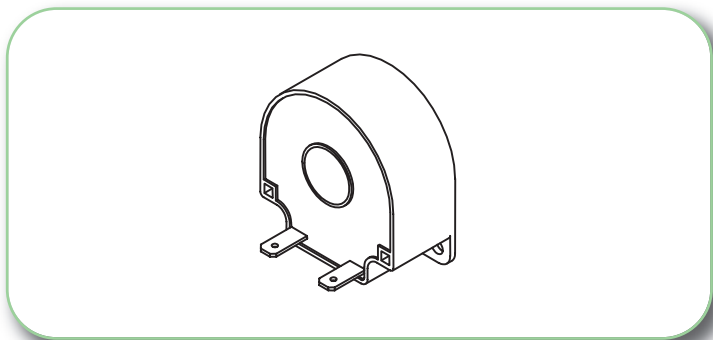

MYRRA Part N°	Sec. Turns	Max Pri. Current A rms	Rsec. Ω max	Lsec. mH min	Pulse Vsec x t max @ Frequency	Sine Vsec max @ Frequency	Typical Load/ Accuracy/ Current
74541	100	200 A	0.35 Ω	50	2 V.ms/ 20 kHz 1 V.ms/ 100 kHz	150 V/ 20 kHz 150 V/ 100 kHz	1.20 Ω / 1%
74544	500	100 A	6.5 Ω	1250	10 V.ms/ 50 Hz	0.7 V/ 50Hz/ 100 A 1.2 V/ 50Hz/ 60 A	≤ 3 Ω / 1% / 100 A ≤ 10 Ω / 1% / 60 A
74547	1000	250 A	22 Ω	8000	100 V.ms/ 50 Hz	15 V/ 50 Hz/ 250 A	≤ 50 Ω / 1% / 250 A

Data applies for one primary turn (single passage of primary wire through toroid hole). Sensitivity can be increased for lower currents by winding more than one turn.

74541/ 74544/ 74547 FASTON Connectors (4.8 x 0.8)

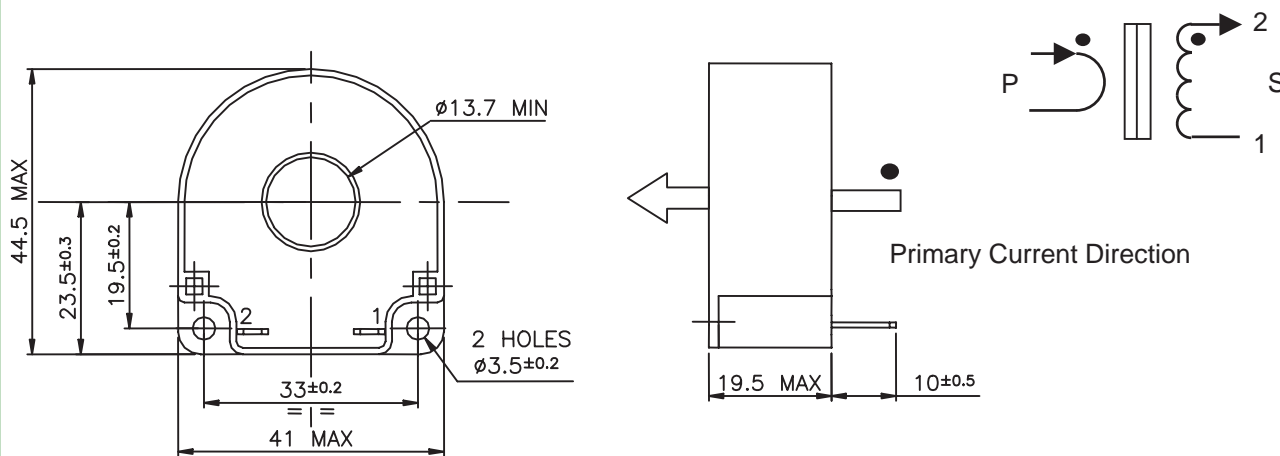

HIGH FREQUENCY FERRITE
CURRENT TRANSFORMERS RANGE

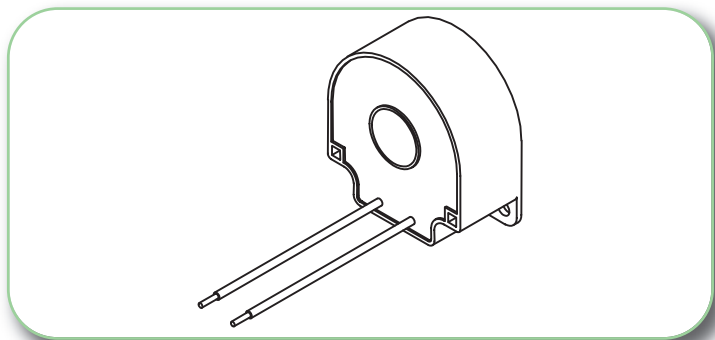

MYRRA Part N°	Sec. Turns	Max Pri. Current A rms	Rsec. Ω max	Lsec. mH min	Pulse Vsec x t max @ Frequency	Sine Vsec max @ Frequency	Typical Load/ Accuracy/ Current
74542	100	200 A	0.35 Ω	50	2 V.ms/ 20 kHz 1 V.ms/ 100 kHz	150 V/ 20 kHz 150 V/ 100 kHz	1..20 Ω / 1%
74545	500	100 A	6.5 Ω	1250	10 V.ms/ 50 Hz	0.7 V/ 50Hz/ 100 A 1.2 V/ 50Hz/ 60 A	≤ 3 Ω / 1% / 100 A ≤ 10 Ω / 1% / 60 A
74548	1000	250 A	22 Ω	8000	100 V.ms/ 50 Hz	15 V/ 50 Hz/ 250 A	≤ 50 Ω / 1% / 250 A

Data applies for one primary turn (single passage of primary wire through toroid hole).
Sensitivity can be increased for lower currents by winding more than one turn.

74542/ 74545/ 74548 Wires type

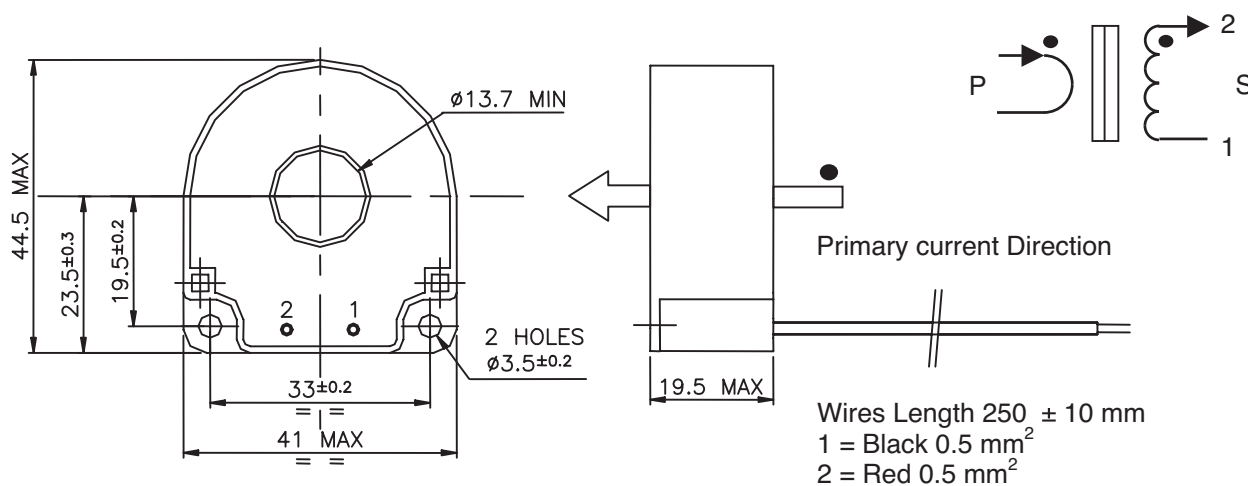

HIGH FREQUENCY FERRITE
CURRENT TRANSFORMERS RANGE

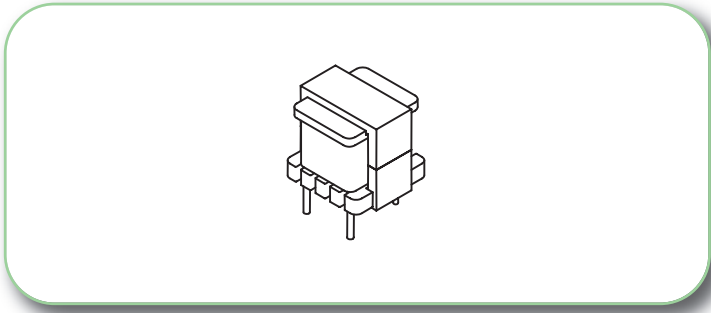

FOR SWITCH MODE POWER SUPPLIES - 20 to 150 kHz								
MYRRA Part N°	Ratio	Max Pri. Current A rms	Rsec. Ω max	Lsec. mH min	Pulse Vsec x t max	Sine Vsec rms max	Typical Load/ Accuracy/ Current	Insulation Voltage P/S
74550	1/100	10	2.3	6	250 V.µs	40 Vrms	10 – 100 Ω / 1% / 10 A	1500 V

SAFETY :

This product is only composed of UL approved materials.

This product has a construction conform to CEI950, CEI335, CEI61558 for functional insulation

74550

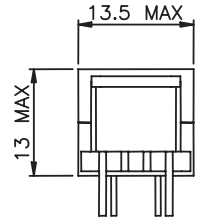
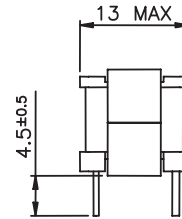
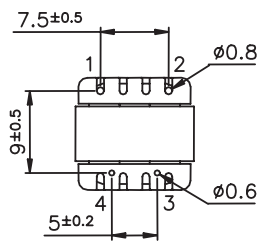
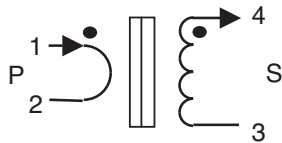

PCB drill @ Ø 1 & 1.3 mm

HIGH FREQUENCY FERRITE
CURRENT TRANSFORMERS RANGE

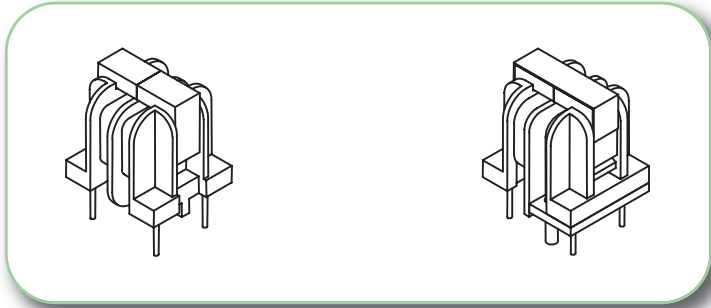

FOR SWITCH MODE POWER SUPPLIES - 20 to 150 kHz

MYRRA Part N°	Ratio	Max Pri. Current A rms	Rsec. Ω max	Lsec. mH min	Pulse Vsec x t max	Sine Vsec rms max	Typical Load/ Accuracy/ Current	Insulation Voltage P/S
74560	1/100	10	1.1	12	300 V.µs	25 Vrms	5 – 50 Ω / 1% / 10 A	4000 V
74562	1/100	25	1.1	12	300 V.µs	25 Vrms	5 – 50 Ω / 1% / 25 A	4000 V

FOR MAINS AC CURRENT MEASUREMENT - 50 to 400 Hz

MYRRA Part N°	Ratio	Max Pri. Current A rms	Rsec. Ω max	Lsec. mH min	Pulse Vsec x t max	Sine Vsec rms max	Typical Load/ Accuracy/ Current	Insulation Voltage P/S
74561	1/2000	8 A	400	4.5 H	5 V.ms	1 Vrms	≤ 100 Ω / 2% / 6 A	4000 V

SAFETY :

These products are only composed of UL approved materials.

These products have a construction conform to CEI950, CEI335, CEI61558 for Reinforced insulation

74560, 74561 : 8 mm creepage distance

74562 : 6 mm creepage distance

74560/ 74561

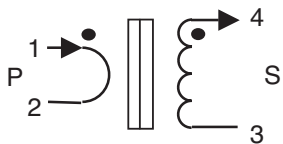

PCB drill @ Ø 1.1 & 2.2 mm

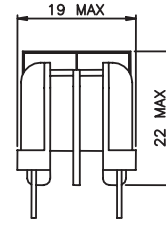
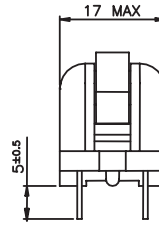
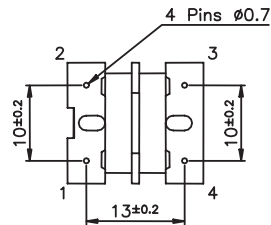

74562

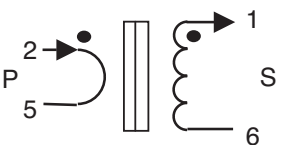

PCB drill @ Ø 1.1 & 2.2 mm

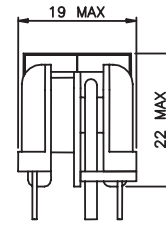
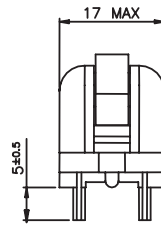
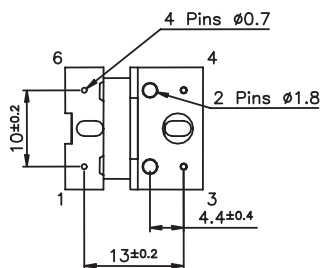

HIGH FREQUENCY FERRITE
CURRENT TRANSFORMERS RANGE

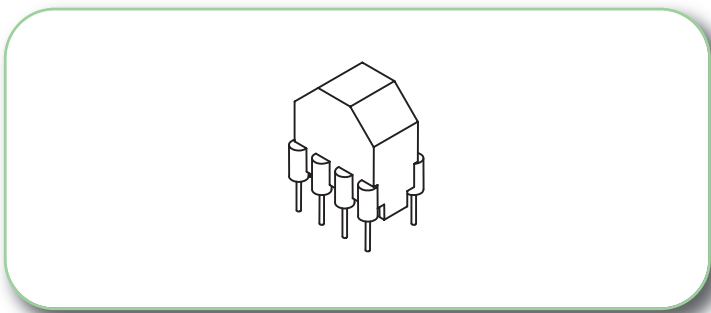

FOR SWITCH MODE POWER SUPPLIES - 20 to 150 kHz								
MYRRA Part N°	Ratio	Max Pri. Current A rms	Rsec. Ω max	Lsec. mH min	Pulse Vsec x t max	Sine Vsec rms max	Typical Load/ Accuracy/ Current	Insulation Voltage P/ S
74570	1/1/50	20 A parallel 10 A serie	0.32	9	150 V.µs	12 Vrms	5 – 25 Ω / 1% / 20 A	4000 V

st at myrra.com

SAFETY :

This product is only composed of UL approved materials.
 This product has a construction conform to CEI950, CEI335, CEI61558 for Reinforced insulation (8 mm creepage distance)

74570

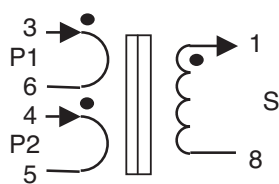

Pins 2 & 7 removed for locating
 PCB drill @ Ø 1.1mm

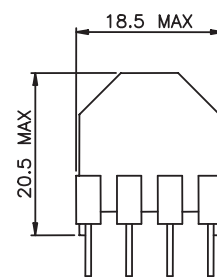
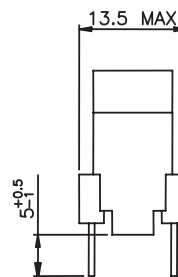
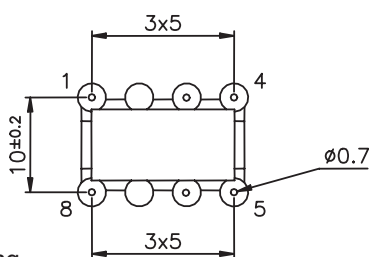

HIGH FREQUENCY FERRITE
 CURRENT TRANSFORMERS RANGE

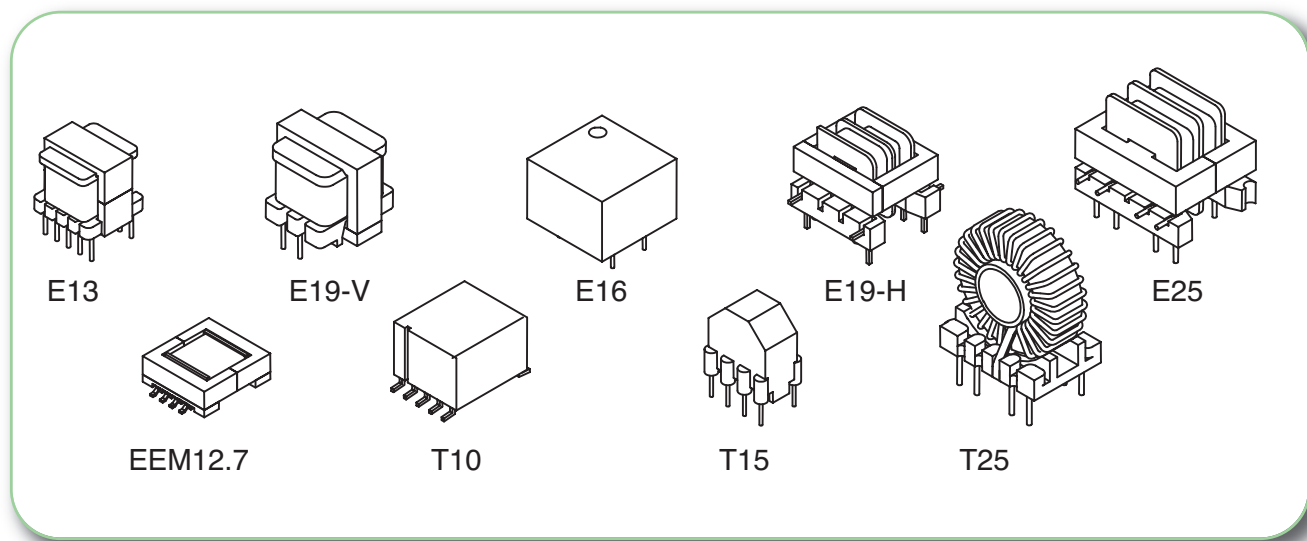

To be used for MOSFET or IGBT Drive, SCR triggering, DC/DC power conversion, Voltage isolation.

MYRRA Part N°	SIZE	Ratio	
74600	Size T15	Ratio 1 / 1 / 1	Low stray inductance
74610	Size T25	Ratio 1 / 1 / 1	Low stray inductance
74611	Size T25	Ratio 1 / 1 / 1	Low stray inductance
74620	Size E19-H	Ratio 1 / 1 / 1	Low coupling capacitance
74621	Size E19-H	Ratio 3 / 1 / 1	Low coupling capacitance
74630	Size E25	Ratio 1 / 1 / 1	Low coupling capacitance
74631	Size E25	Ratio 3 / 1 / 1	Low coupling capacitance
74640	Size E19-V	Ratio 1 / 5	For voltage step-up
74641	Size E19-V	Ratio 1 / 10	For voltage step-up
74650	Size E13	Ratio 1 / 1 / 1	Small size
74710	Size E16	Ratio 1 / 1	Low coupling capacitance
74660	Size EEM12.7	Ratio 1CT / 1.3CT	SMD
74661	Size EEM12.7	Ratio 1CT / 1CT	SMD, for DC/DC converter
74670	Size T10	Ratio 1CT / 1.3	SMD, Low stray inductance

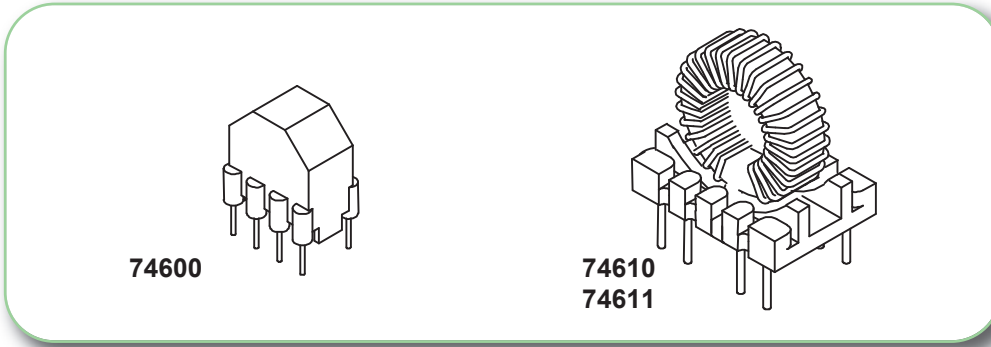

MYRRA Part N°	Ratio P/S1/S2	L pri. +/-30%	Current /winding Arms max	Resistance /winding Ω max	Pulse E x t V.µs max	square V / kHz max	C P/S pF max	Lleak P/S max	Insulation Voltage	
									P/S	S1/S2
74600	1 / 1 / 1	4 – 8	0.6	0.35	150 V.µs	0.4	120 pF	1.0 µH	4 kV	4 kV
74610	1 / 1 / 1	0.6 – 1.2	1.7	0.07	150 V.µs	0.4	35 pF	0.6 µH	4 kV	4 kV
74611	1 / 1 / 1	2.5 - 5	1.2	0.14	300 V.µs	0.8	90 pF	1.2 µH	4 kV	4 kV

- Toroid core gives best coupling, lowest leakage inductance, fast rise time.
- Pulse (E.t rating) is given for bipolar (symmetrical) pulse. Value is reduced for unipolar pulse.

SAFETY :

- These products are only composed of UL-V0 approved materials.
- Insulation test voltage : 4000 Vrms
- This product has a construction conform to CEI950, CEI335, CEI61558 for Reinforced insulation (8 mm creepage distance)

74600 Size T15

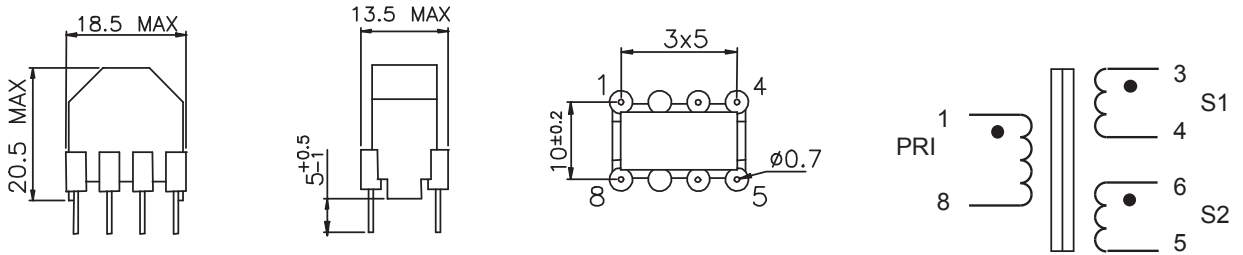

Pins 2 & 7 removed for locating PCB drill @ Ø 1.1mm Weight ≈ 6 g

74610 - 74611 Size T25

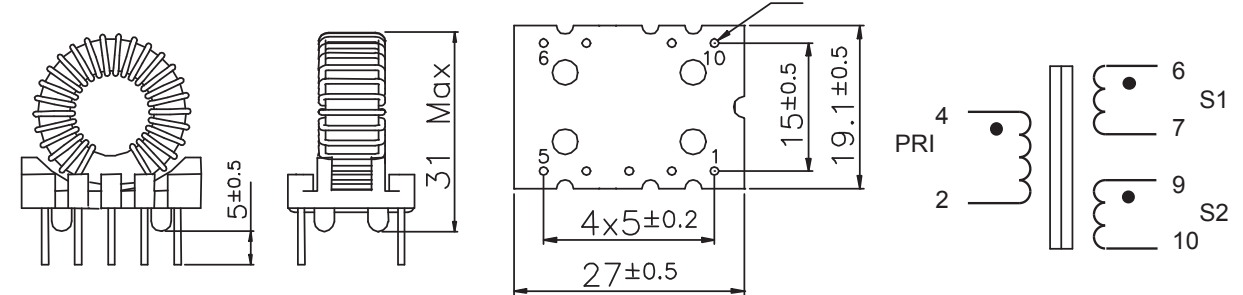

Pin 8 removed for locating PCB drill @ Ø 1.3mm Weight ≈ 18 g

HIGH FREQUENCY FERRITE
PULSE TRANSFORMERS

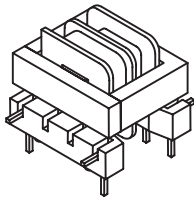

74620
74621

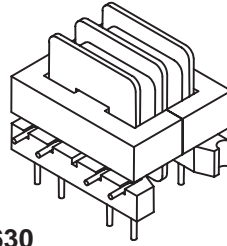

74630
74631

MYRRA Part N°	Ratio P/S1/S2	L pri. +/-30%	Current /winding Arms max	Resistance /winding Ω max	Pulse Ext V.µs max	square V / kHz max	C P/S pF max	Leak P/S max	Insulation Voltage	
									P/S	S1/S2
74620	1 / 1 / 1	3.2 mH	0.5	1.0	350 V.µs	0.6	5 pF	70 µH	2.5 kV	1.5 kV
74621	3 / 1 / 1	17 mH	0.3	2.0	800 V.µs	1.5	5 pF	400 µH	2.5 kV	1.5 kV
74630	1 / 1 / 1	2 mH	1	0.4	500 V.µs	0.8	7 pF	60 µH	2.5 kV	1.5 kV
74631	3 / 1 / 1	10 mH	0.45	0.8	1000 V.µs	1.7	7 pF	300 µH	2.5 kV	1.5 kV

- Principally dedicated to SCR triggering
- Designed for minimum coupling capacitance

SAFETY :

These products are only composed of UL-V0 approved materials.

74620 - 74621 Size E19-H

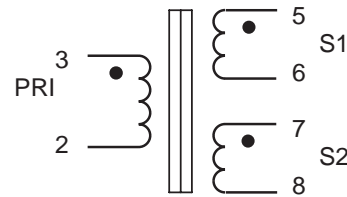
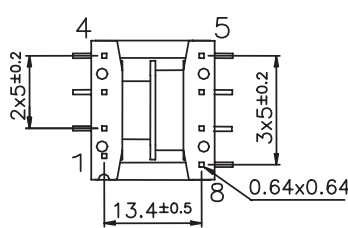
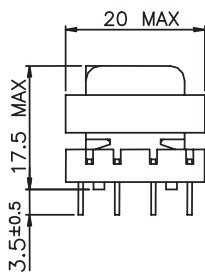
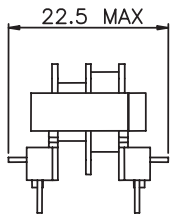

Pin 1 removed for locating

PCB drill @ Ø 1.3mm

Weight ≈ 12 g

74630 - 74631 Size E25

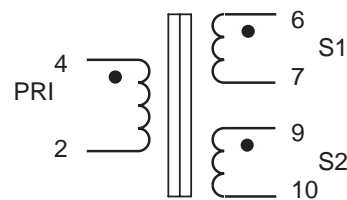
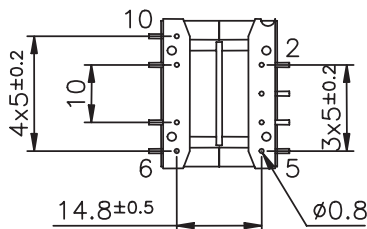
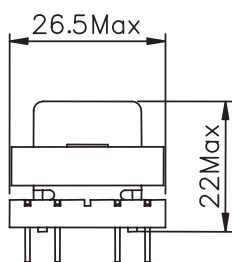
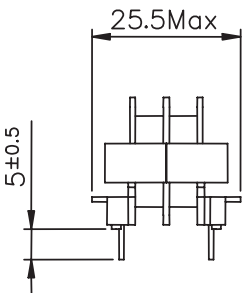

Pins 1 & 8 removed for locating

PCB drill @ Ø 1.3mm

Weight ≈ 20 g

HIGH FREQUENCY FERRITE
PULSE TRANSFORMERS

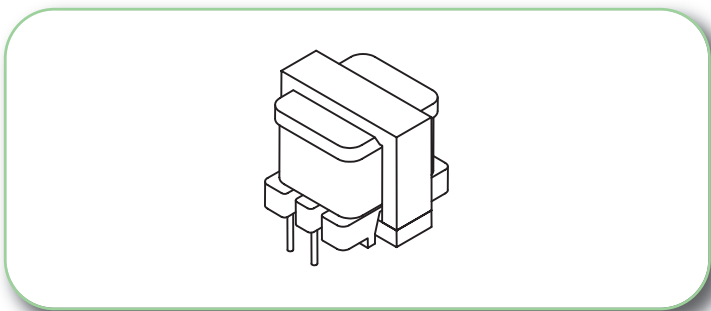

MYRRA Part N°	Ratio P/S	L pri. +/-30%	Current Arms max	Resistance Ω max	Pulse Vsec. t max	Sine Vsec. max	Insulation Voltage P/S
74640	1 / 5	11 mH	Pri : 0.5 Sec : 0.1	Pri : 1.0 Sec : 31	16 V.ms	4 Vrms / 50 Hz 50 Vrms / 5 kHz	1500
74641	1 / 10	11 mH	Pri : 0.4 Sec : 0.04	Pri : 1.8 Sec : 80 Ω	33 V.ms	8 Vrms / 50 Hz 100 Vrms / 5 kHz	1500

SAFETY :

- These products are only composed of UL-V0 approved materials.

74640-74641 Size E19-V

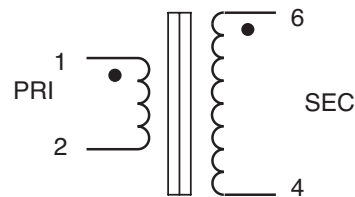
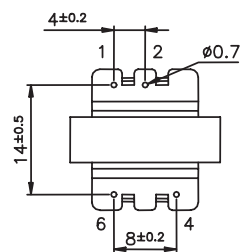
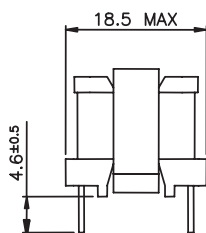
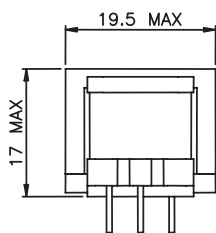

Pins 3 & 5 removed for locating

PCB drill @ \varnothing 1.1mm

Weight \approx 14 g

HIGH FREQUENCY FERRITE
PULSE TRANSFORMERS

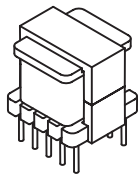

74650

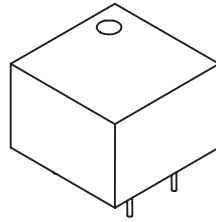

74710

MYRRA Part N°	Ratio P/S1/S2	L pri.	Current / winding Arms max	Resistance / winding Ω max	Pulse Ext V.µs max	square V / kHz max	C P/S pF max	Lleak P/S max	Insulation Voltage	
									P/S	S1/S2
74650	1 / 1 / 1	500 µH +/-30%	0.6	0.28	120 V.µs	20V/ 100kHz	12 pF	2 µH	1.5 kV	1.5 kV
74710	1 / 1	2 mH +/-40%	0.6	0.6	300 V.µs	50V/ 100kHz	6 pF	44 µH	4 kV	

- 74650 is principally designed for Mosfet drive in SMPS (Forward or Bridge converters)
- 74710 is principally designed for SCR Triggering

SAFETY :

These products are only composed of UL-V0 approved materials.

The product 74710 has a construction conform to CEI950, CEI335, CEI61558 for Reinforced insulation (8 mm creepage distance)

74650 Size E13

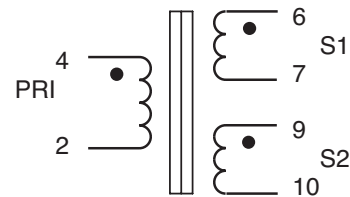
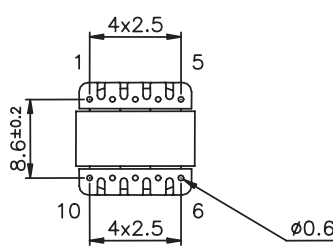
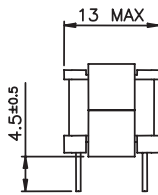
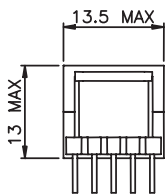

Pin 8 removed for locating

PCB drill @ Ø 1.1mm

Weight ≈ 4 g

74710 Size E16

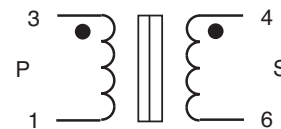
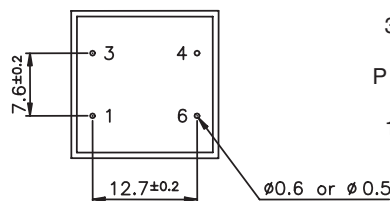
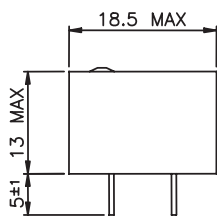
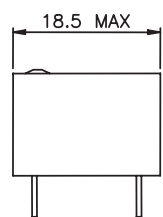

PCB drill @ Ø 1.1mm

Weight ≈ 8 g

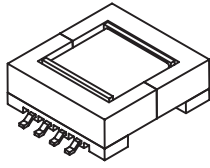

74660 - 74661

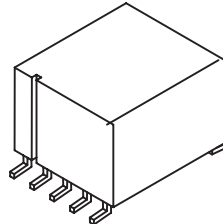

74670

MYRRA Part N°	Ratio P/S	L pri.	Current / winding max	Resistance / winding Ω max	Pulse E x t max P1 or P2	square V / kHz max P1 or P2	C P/S pF max	Lleak P/S max	Insulation Voltage
									P/S
74660	1+1 / 1.3+1.3	240 μ H +/-30%	0.2 Arms	0.9	50 V. μ s	15V 100 – 500kHz	20 pF	0.35 μ H	0.5 kV
74661	1+1 / 1+1	10 μ H +/-10%	3 Apeak 0.5 Arms	0.2	30 V. μ s	0.05 V / kHz 100 – 400kHz	20 pF	0.2 μ H	0.5 kV
74670	1+1 / 1.3	220 μ H +/-30%	0.4 Arms	0.25	15 V. μ s	0.03 V / kHz 100 – 500kHz	12 pF	0.4 μ H	4 kV

- 74660 can be used in association with MAXIM MAX250 or MAX253
- 74661 can be used in association with LINEAR TECHNOLOGY LT1424
- 74660 can be used in association with MAXIM MAX845

SAFETY :

These products are only composed of UL-V0 approved materials.

74660 – 74661 Size EEM12.7

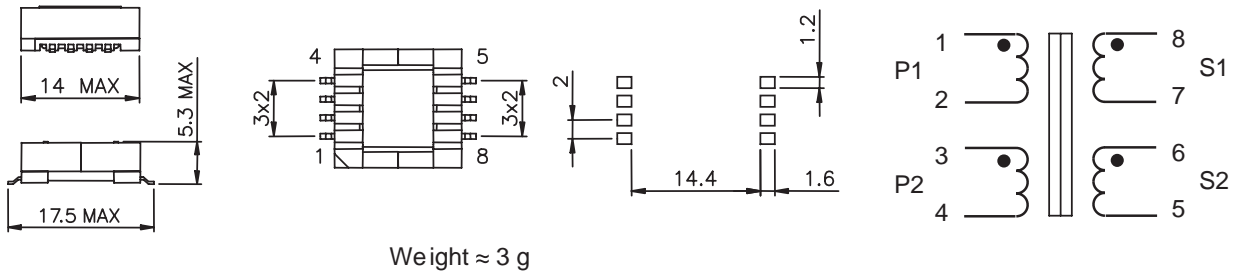

74670 Size T10

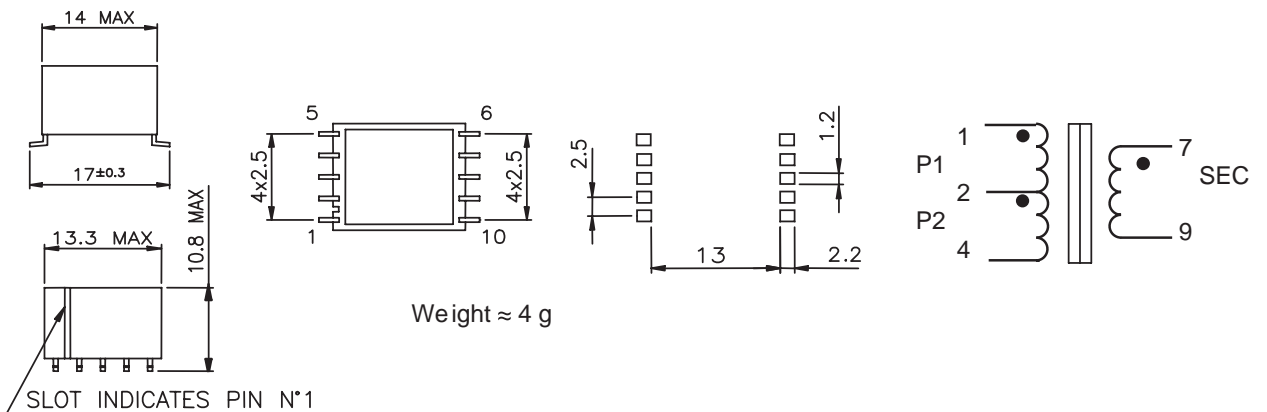

HIGH FREQUENCY FERRITE
PULSE TRANSFORMERS

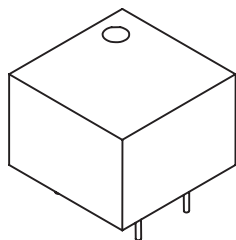

74710 - 74716 - 74717

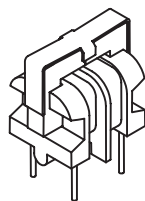

74711

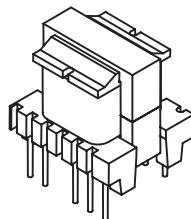

74712

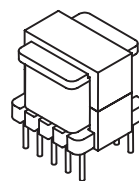

74713

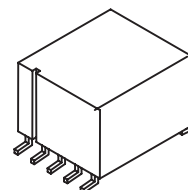

74714 - 74715

- Designed for coupling signals to power line
- Adapted for use with Modem Circuits : **ST7537, ST7538, TDA5051 or IC/SS**

MYRRA Part N°	Inductance (µH)	Leakage Inductance (µH)	Resistance per winding P/ S (max)	Frequency range	Turns ratio P/ S	Max Sec. current (mA rms) (50 - 60 Hz)	Insulation (Vrms)	Size
74714	1300 +/-40 % (2-4)	< 0.5	0.2 Ω / 0.2 Ω	10 – 200kHz	1 / 1	4	5500	T10-SMD
74715	3.0 +/-25 % (7-9)	< 0.1	0.06 Ω / 0.1 Ω	1 – 20 MHz	2 / 1+1	200	4000	T10-SMD

74714 - 74715

Reinforced insulation, creepage distance > 8 mm

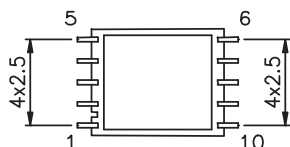
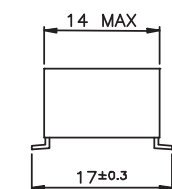

74714

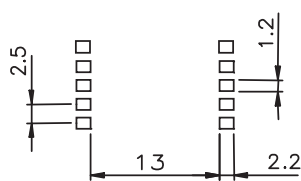
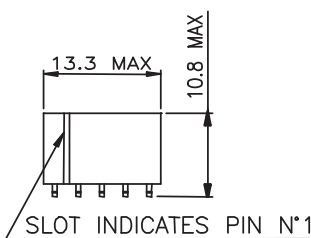
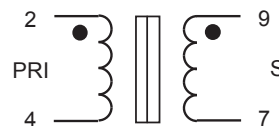

74715

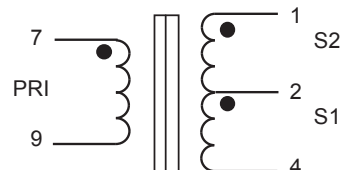

HIGH FREQUENCY FERRITE
POWER LINE COMMUNICATION



MYRRA Part N°	Inductance (µH)	Leakage Inductance (µH)	Resistance per winding P / S (max)	Frequency range	Turns ratio P / S	Max Sec. current (mA rms) (50 - 60 Hz)	Insulation (Vrms)	Size
74710	2000 +/-40 % (1 - 3)	44 +/-7%	0.6 Ω / 0.6 Ω	10 - 450kHz	1 / 1	10	4000	EF16-H-4P
74711	2900 +/-40% (1 - 2)	44 +/-7%	1 Ω / 1 Ω	10 - 200kHz	1 / 1	4	1500	U9.8-4P
74716	45000 +/- 40 % (3 - 1)	1500 +/-10 %	12 Ω / 14 Ω	10 - 200kHz	1/1.15	4	4000	EF 16 H - 5P
74717	400 +/- 40 % (3 - 1)	14.4 +/- 10 %	0.3 Ω / 0.5 Ω	20 - 450kHz	1/1.67	40	4000	EF 16 H - 5P

• 74710 - 74711 - 74716 - 74717

Typical application :

Designed for resonance of series coupling capacitor and the transformer leakage inductance.

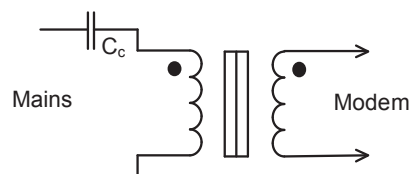

MYRRA Part N°	Series Resonance Frequency (kHz)	Mains Coupling capacitance (nF)
74710	132.5	33
74711	132.5	33
74716	50	6.8
74717	40 - 90	470

74710 Reinforced insulation, creepage distance > 8 mm

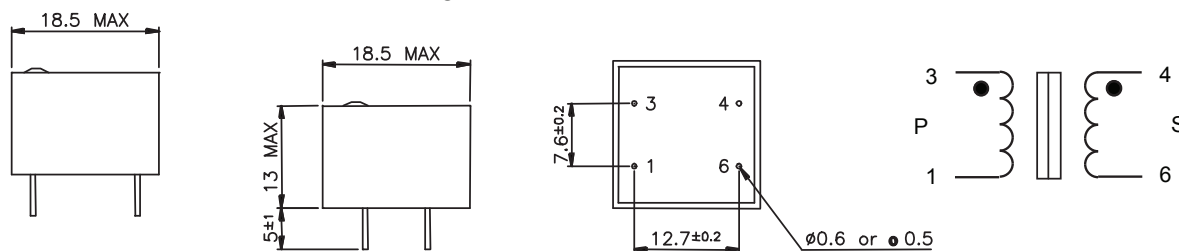

74711 Functional insulation

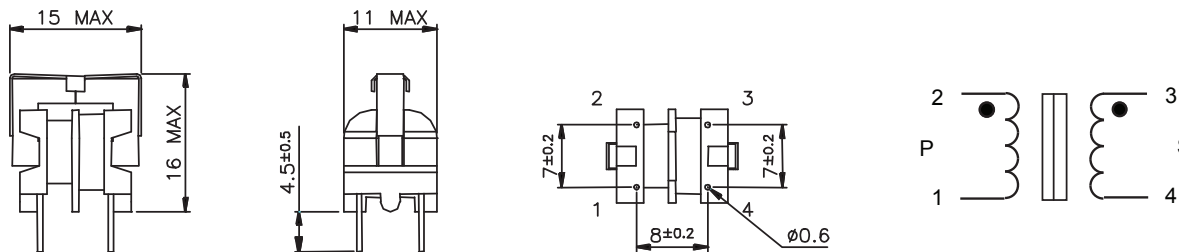

74716 - 74717 Reinforced insulation, creepage distance > 8 mm

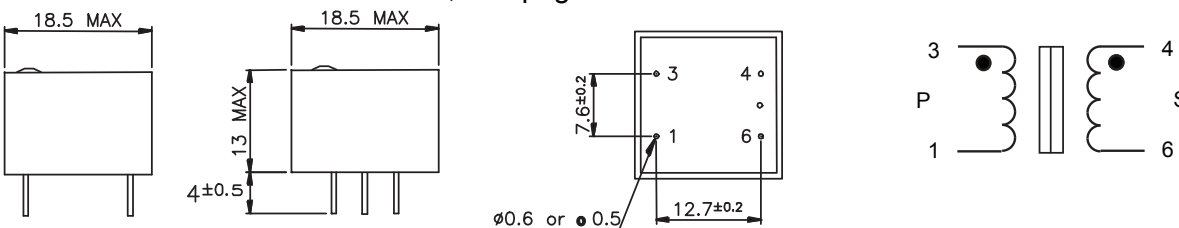

HIGH FREQUENCY FERRITE
POWER LINE COMMUNICATION



MYRRA Part N°	Inductance (μH)	Leakage Inductance (μH)	Resistance per winding P / S (max)	Frequency range	Turns ratio P / S	Max Sec. current (mA rms) (50 - 60 Hz)	Insulation (Vrms)	Size
74712	212 +/-10 % (2-5)	<5 (2-5)	0.8 Ω / 0.04 Ω	10kHz – 1MHz	5+1 / 1	500	4000	E16-V-10P
74713	144 +/-10 % (2-5)	<5	0.5 Ω / 0.5 Ω	10 – 450kHz	5+1 / 5+1	200	1500	E13-V-10P

• 74712 - 74713

Typical application :

Designed for resonance of parallel capacitor with the primary magnetizing inductance.

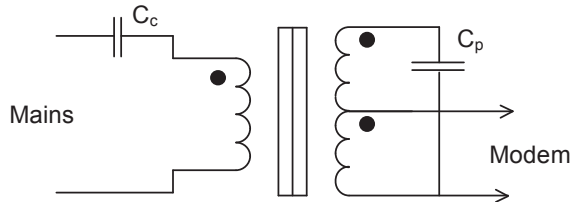

MYRRA Part N°	Parallels Resonance Frequency (kHz)	Mains Coupling capacitor(nF)	Parallel capacitor (nF)
74712	132.5	33	6.8
74713	132.5	33	10

74712

Reinforced insulation, creepage distance > 6 mm

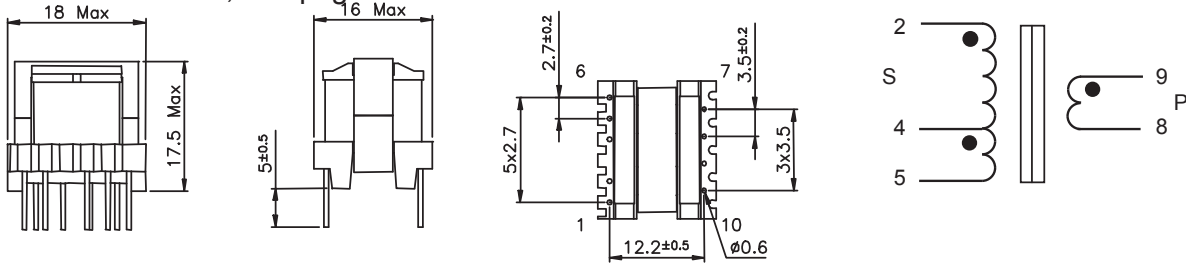

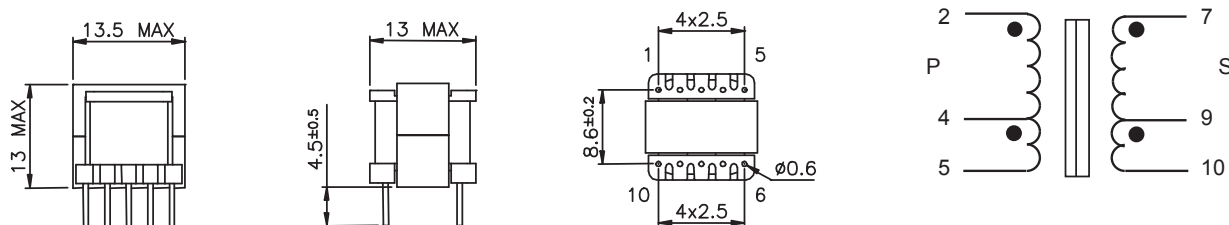

74713

Functional insulation







THROUGH HOLES CHOKES

	Available sizes	Values	Applications
DC SERIES 		Drum Cores	
	(\varnothing x H) mm : 04x06 - 05x07 06 x07 - 07x08 - 07x10 08x09 - 09x12 - 10x13 - 11x12 -11x14 - 11x18 - 13x15	1 μ H to 150 mH - 9.3 to 0.03 ADC	DC-DC converters ADSL-computers
RC SERIES 		Rod Chokes	
	(\varnothing xL) : 02x06 - 03x10 04x15 - 05x20 - 06x30	1 to 56 μ H - 0.56 to 1.57 ADC	Power supply - Power amplifier
CMT SERIES 		Common Mode Toroids	
	on request	on request	Power supply EMI suppression Wideband chokes

SURFACE MOUNT CHOKES

	Available sizes	Values	Applications
PI SERIES 		Power inductors	
	32 - 42 - 43 - 53 - 54 - 73 75 - 104 - 105	1 to 820 μ H 0,24 to 6.8 A	DC-DC converters DC-AC inverters Switching power supplies
SPI SERIES 		Shielded Power inductors	
	73 - 74 - 124 - 125 - 127	1.2 to 1000 μ H 10.6 to 0.18 Arms	DC-DC converters DC-AC inverters Chargers

POWER SUPPLIES 1W to 60W



MYRRA encapsulated Switched Mode Power Supplies is based on Flyback topology.

They constitute an interesting alternative to the traditional supply in the most common applications of power from 1W to 60W.

ENERGY SAVING due to high efficiency and low standby power.



MAIN FEATURES

- Wide input voltage range
- Increased power: 3 x compared to standard EE20-EI30-EI38 transformers
- Better energetic efficiency: 70% typical compared to 40% for the conventional supply
- Very low Standby Power consumption: meets requirements of Energy Star or EC Code of Conduct
- Same footprint as EE20-EI30-EI38-EI48 transformer: (1W~10W)
Upgrade your application without redesign of PCB

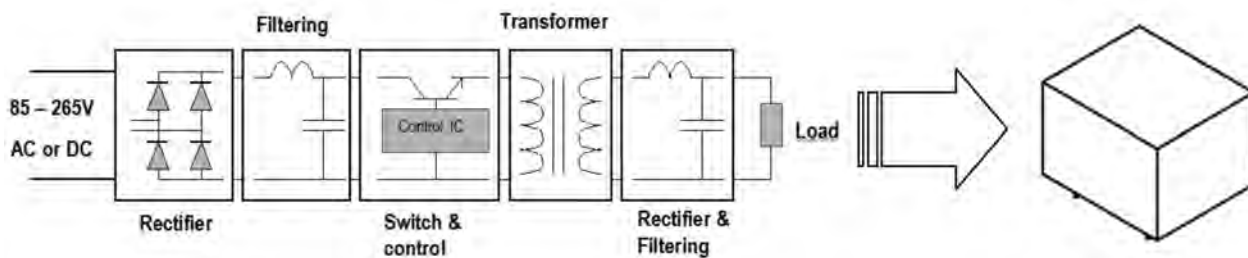

Application for our Power Supplies:

- Alternative to the linear transformers in all AC/DC applications of power up to 60W
- Alternative to DC/DC converters for application in D.C. current (Telecom supplies, electric substations etc.)
- Industrial, domestic and consumer electronics applications
- Standby devices and others DC or AC auxiliary supplies

With the same footprint as an EI30 transformer, they will replace:

- 50 Hz Transformer
- Fuse
- Bridge Rectifier
- Filtering Capacitor

Regulated types will also replace linear regulator and heatsink

SAFETY STANDARDS

Meets all requirements of:

- EN 60950
- EN 60335
- EN 61558-2-16
- EN 61558-1
- UL 60950-1
- CSA 22.2 N°60950-1
- UL 94-V0

EMC STANDARDS

Conducted and radiated emissions conform to

- EN 55014-1
- EN 55032 class B

Immunity conform to

- EN 55014-2
- EN 61000-4-x



1W to 3W

3 Certified Power Ratings
in
1 Power Supply



2.5W to 5W



7.5W



10W



20W to 60W





48000 Series

Single Output 1W ~3W

47000 Series

Single Output 2.5W ~ 5W

Single Output 2.4W ~ 5W (relaxed regulation)

Dual Output 3W ~ 5W (common ground)

Dual Output 3W ~ 4W (isolated outputs)

Single Output 7.5W

Single Output 10W

Single Output 20W

Single Output 30W ~ 40W

Single Output 40W ~ 60W

Modified and Custom Solutions

TECHNICAL SERVICES :

- Alternative DC Output Voltages
- Single, Dual or Triple Output Voltages
- Addition of Signal Pins for AC OK, Remote on/off, sense etc.
- Alternative Power Rating
- Revised 'Hold-up' timing to suit System needs
- Customer specific product 'Branding/Labeling'
- Specific Power Supply Manufacturing Functional Test Profile
- Integrating the Power Supply on the System PCB
- Alternative Power Supply Housing
- Revised DC Output Filtering

CUSTOMER SERVICES :

- Existing Designs for Modified Standards
- Flexible Manufacturing Batch Sizes
- European Stock-holding locations
- European Engineering and Logistics Support
- Country Specific Distribution Partners
- Manufacturing dynamics for Volume Fluctuations
- Myrra Quality Controlled Design and Manufacturing
- Fast Sample Service

Dedicated Power Supplies Catalogue available

Encapsulated Solutions 1W to 60W

hard copy or online at Myrra.com



POWER PRODUCTS TECHNOLOGIES

One of Myrra core competence is to provide customers with a high level of production technology combining know-how and experience over 40 years.

High-frequency transformers and chokes up to 100KW
Lamination 50Hz transformers and chokes up to 20KVA

- **Core** : Laminated steel for 50Hz
Amorphous Core
Nanocrystalin Cores
Powder Core / Sendust / Megaflux / High Flux
Ferrites Core
- **Winding mono or multi-spindle**
Copper or Aluminum
 - Round enameled wire / Litz Wire / TIW
 - Flat wire (rectangular)
 - Foil : up to 400 mm width up to 10 layers simultaneously
- **Automatic or Manual soldering machine** (standard and ultrasonic)
- **Automatic welding machine** up to EI180
- **Varnish** Automatic under vacuum, until 1m3 volume
- **Potting** under vacuum / UL94V0 / EN45545
- **Automatic test system** No Load Test / Full Load Test / Computer controlled
- **Traceability**
 - Parts : Serial Numbers / Barcode
 - Materials : Manufacturer Program / C.O.C.
- **Insulation systems** : B, F, H classes
UL , IEC , CSA compliant

POWER PRODUCTS CONTROL WORKING STATION

A high level of control at all stages of production
100% of parts are tested

Labview software implementation on control station

- With automatic multiplexer MUX

All our test equipments are under calibration :

- Precision multimeters
- Micro-ohmmeters
- Oscilloscopes and Functions Generators
- Impulse Winding Tester 5kV
- Surge Test 12 kV
- HiPot Tester 12 kV
- RLC Impedance Meters, & 75 A DC Bias
- Power HiTester
- Pulse Generator / Saturation Tester

All products are controlled at 100 % during process (1 to 3 times)
and once again at 100% before packaging (final control).



POWER PRODUCTS APPLICATIONS

Myrra is able to demonstrate a great adaptability to the needs and the requirements of the customers with a very high level of competence internationally recognized.

SOLAR

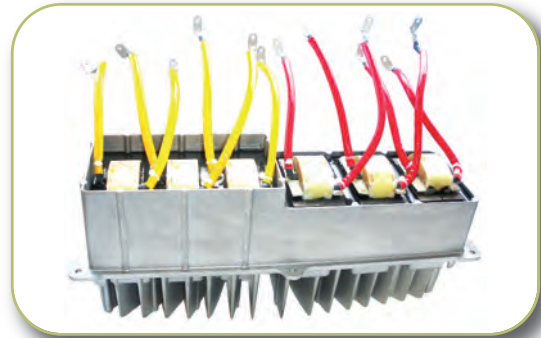
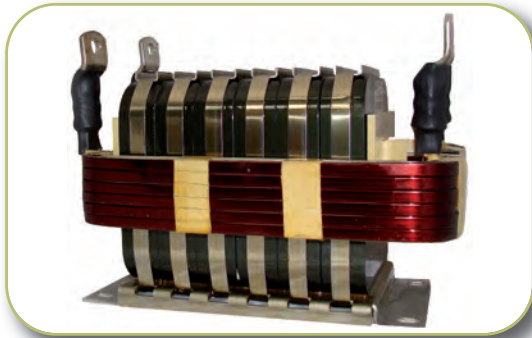

MACHINERY

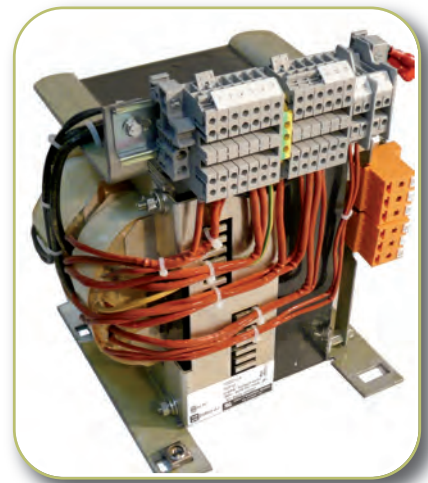
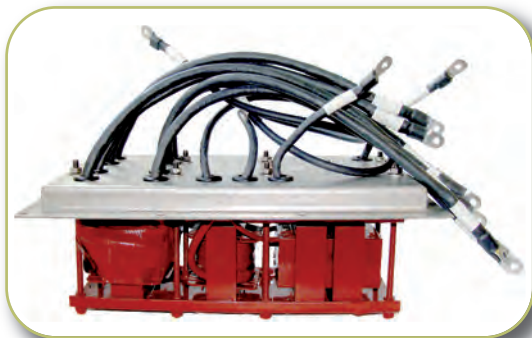

MOTORDRIVE

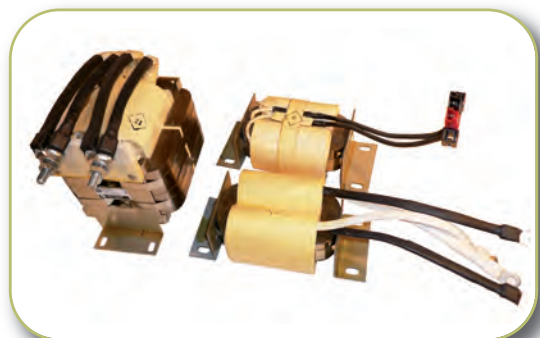
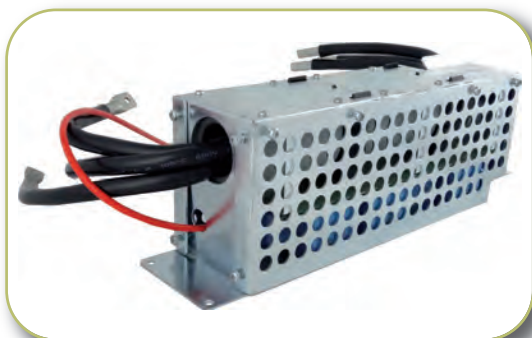



Save valuable time for your specific request for non-standard products



Reminder of the data needed to easily validate your request

Technical:

For all Request:

Ambient	<input type="text"/>
Max dimensions	<input type="text"/>
Required standards approvals	<input type="text"/>

Encapsulated Transformers

Transfo // Autotr.	<input type="text"/>
Power (VA)	<input type="text"/>
Input voltage (V)	<input type="text"/>
Output voltage(s) (V)	<input type="text"/>
Output current(s) (A)	<input type="text"/>
Frequency (Hz)	<input type="text"/>

Chokes (power and 50 Hz)

Type (AC // DC // PFC...)	<input type="text"/>
Inductance value (mH)	<input type="text"/>
Current (Arms)	<input type="text"/>
Ripple freq. (kHz)	<input type="text"/>
Ripple current (Apkpk)	<input type="text"/>
Derating curve (L Vs I)	<input type="text"/>

Common Mode Chokes

Inductance value (mH)	<input type="text"/>
Current (A)	<input type="text"/>
Phases number	<input type="text"/>

HF transformers

Power (W)	<input type="text"/>
Topology (Flyback // forward ...)	<input type="text"/>
Input voltage range (V) Output voltage(s) (V)	<input type="text"/>
Output current(s) (A) Frequency (kHz)	<input type="text"/>
Controller (*)	<input type="text"/>
Level of insulation	<input type="text"/>
Pollution degree	<input type="text"/>

Current transformers

Primary current (Arms)	<input type="text"/>
Ratio	<input type="text"/>
Load (Ω)	<input type="text"/>
Frequency (Hz)	<input type="text"/>
Accuracy	<input type="text"/>
Through hole // Primary pin	<input type="text"/>
Insulation level	<input type="text"/>

Commercial:

Quantity / year	<input type="text"/>
Application	<input type="text"/>
Project	<input type="text"/>
Production start date	<input type="text"/>
Contact details	<input type="text"/>

Go to Design on Request online:
myrra.com



www.myrra.com

**

MYRRA SAS
2 Bd de la Haye
Parc Gustave Eiffel
77600 Bussy St Georges
France

MYRRA Deutschland GmbH
Marie-Curie-Straße 4/1
71083 Herrenberg
Germany