

**ebm-papst St. Georgen GmbH & Co. KG**

Hermann-Papst-Str. 1

D-78112 St. Georgen

Phone +49 (0) 7724 81-0

Fax +49 (0) 7724 81-1309

info2@de.ebmpapst.com

www.ebmpapst.com

Nominal data

Type	DV 6318/2TDH5P	
Phase		3~
Nominal voltage	VDC	48
Nominal voltage range	VDC	36 .. 72
Speed (rpm)	min ⁻¹	6800
Power consumption	W	360
Min. ambient temperature	°C	-20
Max. ambient temperature	°C	65
Air flow	m ³ /h	1100
Sound power level	B	8.9
Sound pressure level	dB(A)	79

ml = Max. load · me = Max. efficiency · fa = Free air · cs = Customer specification · ce = Customer equipment
Subject to change



Technical description

General description	3-phase fan drive with
Impeller material	Glass-fiber reinforced PA plastic
Weight	1.05 kg
Dimensions	172 x 51 mm
Housing material	Die-cast aluminum
Part no.	DV 6318/2TDH5P
Airflow direction	Exhaust over struts
Direction of rotation	Counterclockwise, viewed toward rotor
Storage	Ball bearing
Service life L10 at 40 °C	40.000 h
Service life L10 at maximum temperature	22.500 h
Cable	(+) and GND: AWG 18, UL 1007,
Approval	VDE, CSA, UL



Product drawing

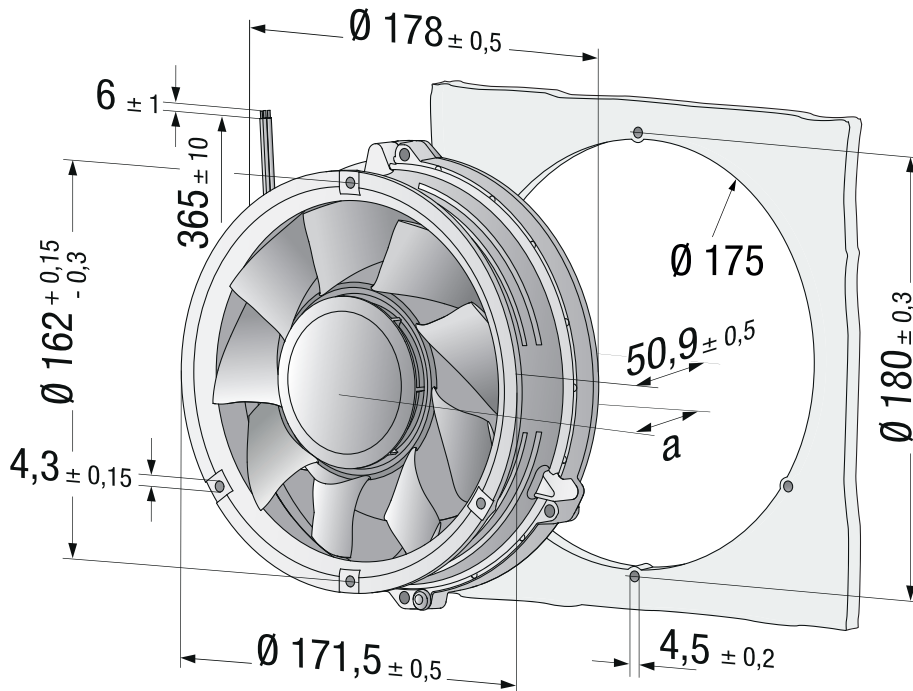

Curves

