



SCAMBIATORI DI CALORE ARIA-ARIA

AIR/AIR HEAT EXCHANGERS
LUFT-LUFT WÄRMETAUSCHER
INTERCAMBIADORES DE CALOR AIRE-AIRE

INDOOR

XVA

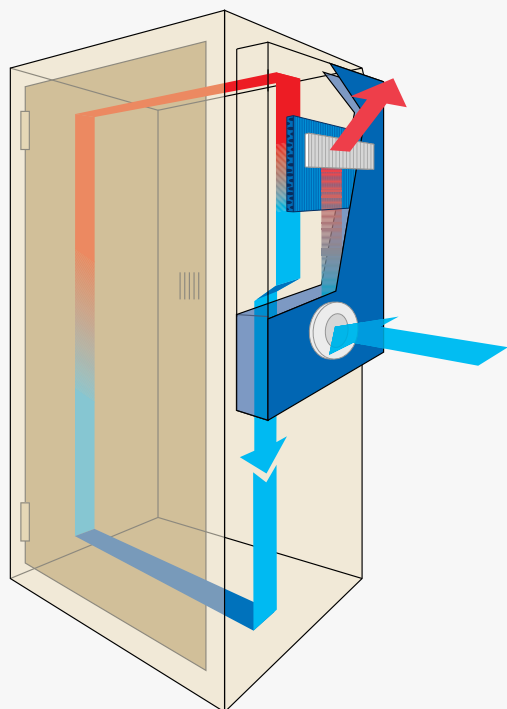

EN

COMMON FEATURES

- Air/Air Heat Exchangers
- 4 sizes
- Patented heat exchange core made of aluminium, to ensure high efficiency with compact dimensions
- Specific Heat Transmission 16-85 W/K

IT

CARATTERISTICHE GENERALI

- Scambiatori di calore aria-aria
- 4 taglie
- Pacco di scambio in alluminio brevettato per garantire grande efficienza con dimensioni ridotte
- Resa specifica 16-85 W/k

DE

ALLGEMEINE MERKMALE

- Luft/Luft Wärmetauscher
- 4 Abmessungen
- Patentierter Wärmetauscher aus Aluminium, um maximale Effizienz bei kompakten Ausmaßen zu garantieren
- Spezifischer Wärmeaustausch 16-85 W/K

ES

CARACTERÍSTICAS COMUNES

- Intercambiadores de calor aire-aire
- 4 tamaños
- Estructura de intercambio en aluminio patentado para garantizar una gran eficiencia con dimensiones reducidas
- Rendimiento específico 16-85 W/k





XVA XVA16

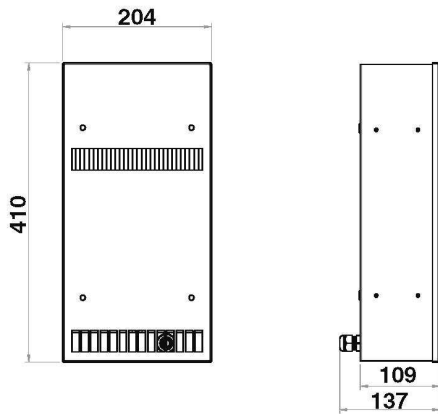
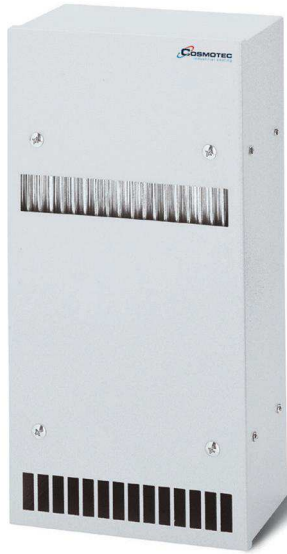

Resa - Performance
Leistung - Rendimiento

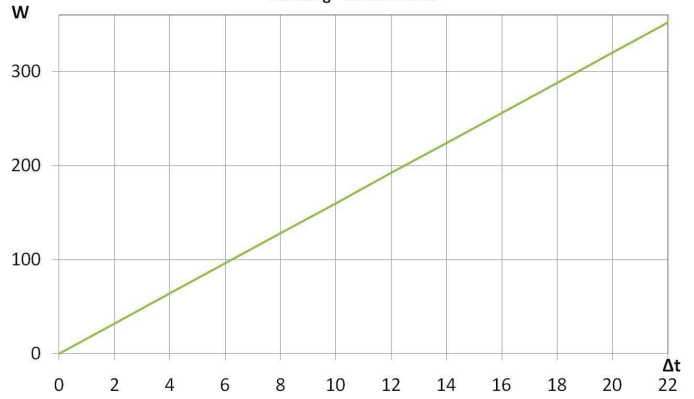

EXTERNAL INSTALLATION

INTERNAL INSTALLATION

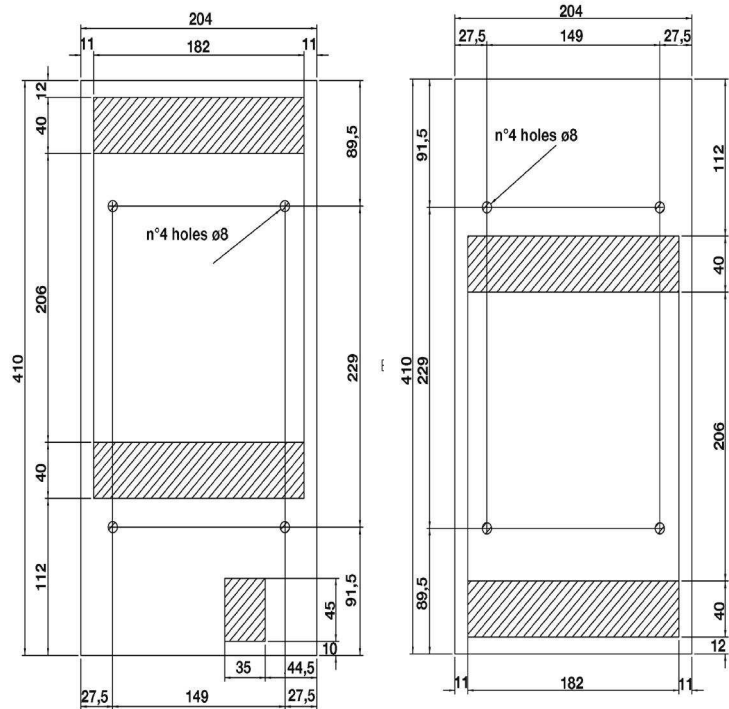

CODE - CODICE - MODEL - CODIGO	M.U.	XVA1600320	XVA16U1303
Power supply - Alimentazione - Spannungsversorgung - Tensiòn	V - ph - Hz	230-1-50/60	115-1-60
Specific heat transmission - Resa specifica - Spezifische Leistung - Rendimiento específico	W/K	16	16
Height / Widht / Depth - Altezza / Larghezza/Profondità Höhe / Breite / Tiefe - Altura / Ancho / Profundidad	mm	410x204x109	410x204x109
Absorbed current - Corrente assorbita - Stromaufnahme - Corriente absorbida	A	0,6	0,6
Pre-Fuse T - Fusibile T - Absicherung T - Elemento previo de fusibile T	A	2	2
Power consumption - Potenza assorbita - Leistungaufnahme - Potencia absorbida	W	64	40
Side cabinet fan flow, free blowing - Portata aria ventil. lato armadio, bocca libera Luftmenge Schrankseite, freiblasend - Caudal aire ventil. Lado armario	m3/h	100	100
Regulation Temperature limits - Limiti di regolazione Temperatura Temperatur Einstellbereich - limites de ajuste de Temperatura	°C	-5 / +55	-5 / +55
Side ambient Temperature limits - Limiti di Temperatura lato ambiente Umgebungstemperatur - Limites Temperatura lado ambiente	°C	-5 / +55	-5 / +55
Side cabinet protection degree - Protezione lato armadio Schutzgrad Schrankseite - Protección lado armario	IP/Type	54	54/12
Noise level - Rumorosità - Geräuschpegel - Nivel de ruido	dB(A)	58	58
Weight - Peso - Gewicht - Peso	kg	4,6	4,6
Installation - Installazione - Installation - Instalación		Internal / External	Internal / External
Mechanical Thermostat - Termostato Meccanico - Mechanischer Thermostat - Termostato mecànico		No	No

OPTIONAL

Special Colour - Colore Speciale OCAXNS06
Stainless Steel Housing - Carpentaria Inox AISI304 OCAXI01



HEAT EXCHANGERS - SCAMBIATORI DI CALORE - WÄRMETAUSCHER - INTERCAMBIADORES DE CALOR
INDOOR - X LINE XVA

HE

XVA XVA35

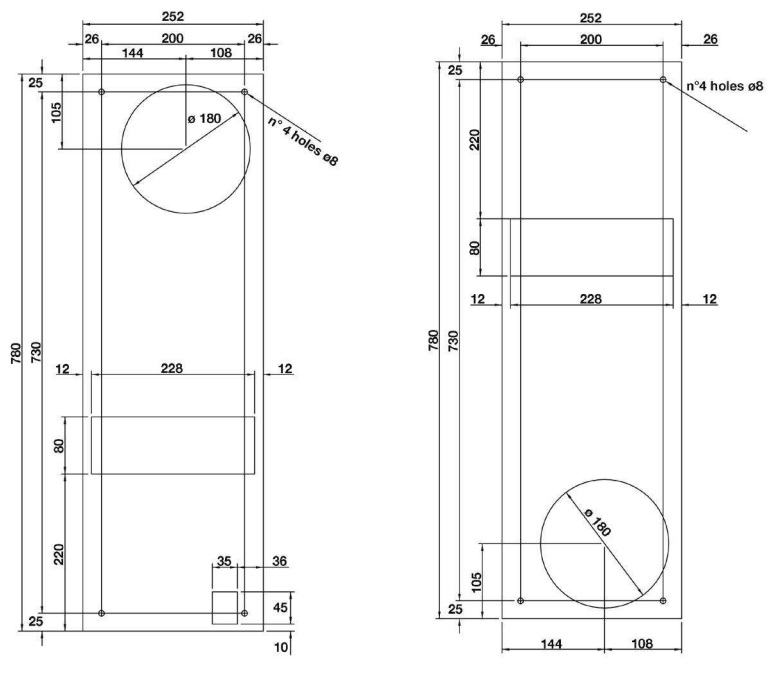
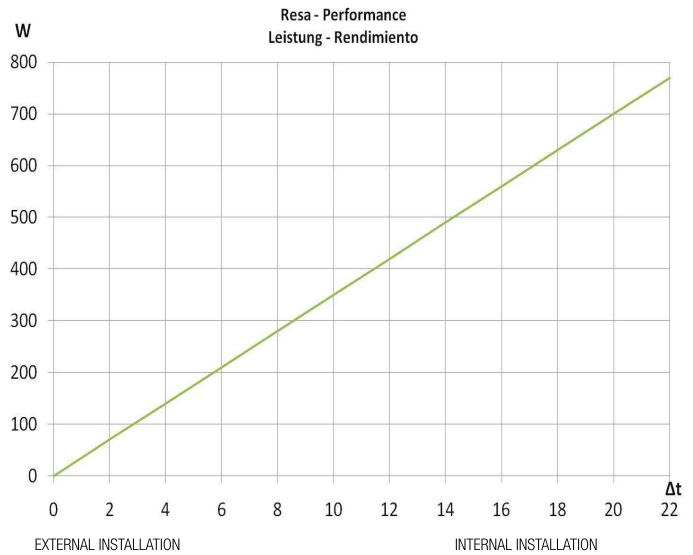
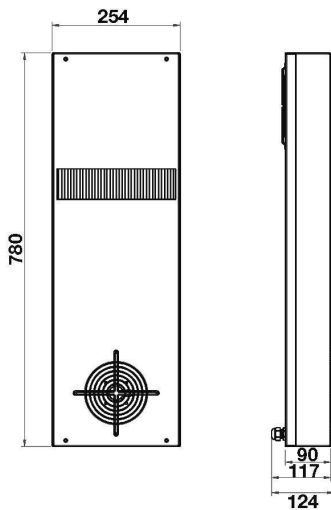

CODE - CODICE - MODEL - CODIGO	M.U.	XVA3500320	XVA35T0120	XVA35T0220	XVA35U1320	XVA35U1303
Power supply - Alimentazione - Spannungsversorgung - Tensión	V - ph - Hz	230-1-50/60	230-1-50/60	230-1-50/60	230-1-60	115-1-60
Specific heat transmission - Resa specifica Spezifische Leistung - Rendimiento específico	W/K	35	35	35	35	35
Height / Widht / Depth - Altezza / Larghezza/Profondità Höhe / Breite / Tiefe - Altura / Ancho / Profundidad	mm	780x254x90	780x254x90	780x254x90	780x254x90	780x254x90
Absorbed current - Corrente assorbita Stromaufnahme - Corriente absorbida	A	0,72	0,72	0,72	0,8	1,1
Pre-Fuse T - Fusibile T - Absicherung T Elemento previo de fusibile T	A	2	2	2	2	4
Power consumption - Potenza assorbita Leistungsaufnahme - Potencia absorbida	W	160	160	160	150	180
Side cabinet fan flow, free blowing - Portata aria ventil. lato armadio, bocca libera Luftmenge Schrankseite, freiblasend - Caudal aire ventil. Lado armario	m ³ /h	575	575	575	575	575
Regulation Temperature limits - Limiti di regolazione Temperatura Temperatur Einstellbereich - limites de ajuste de Temperatura	°C	-5 / +55	-5 / +55	-5 / +55	-5 / +55	-5 / +55
Side ambient Temperature limits - Limiti di Temperatura lato ambiente Umgebungstemperatur - Limites Temperatura lado ambiente	°C	-5 / +55	-5 / +55	-5 / +55	-5 / +55	-5 / +55
Side cabinet protection degree - Protezione lato armadio Schutzgrad Schrankseite - Protección lado armario	IP/Type	55	55	55	54/12	54/12
Noise level - Rumorosità - Geräuschpegel - Nivel de ruido	dB(A)	76	76	76	76	76
Weight - Peso - Gewicht - Peso	kg	7,5	7,5	7,5	7,5	7,5
Installation - Installazione - Installation - Instalación		Interna / External	Internal	External	Internal / External	Internal / External
Mechanical Thermostat - Termostato Meccanico - Mechanischer Thermostat - Termostato mecánico		No	Yes	Yes	No	No

OPTIONAL

Special Colour - Colore Speciale OCAXS03
Stainless Steel Housing - Carpentaria Inox AISI304 OCAXI02



Unità 230 V UL può funzionare anche a 50 Hz
230V UL unit can work with frequency 50 Hz

HEAT EXCHANGERS - SCAMBIATORI DI CALORE - WÄRMETAUSCHER - INTERCAMBIADORES DE CALOR
INDOOR - X LINE XVA



XVA XVA50

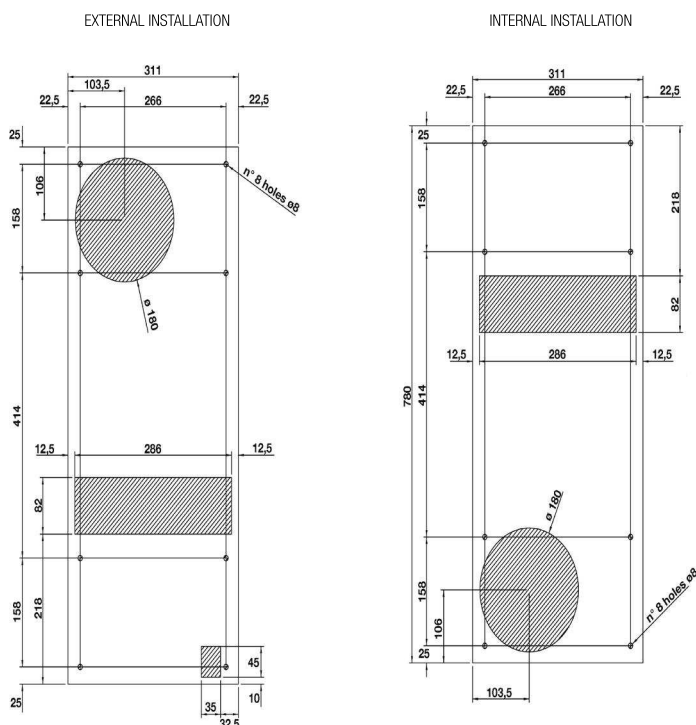
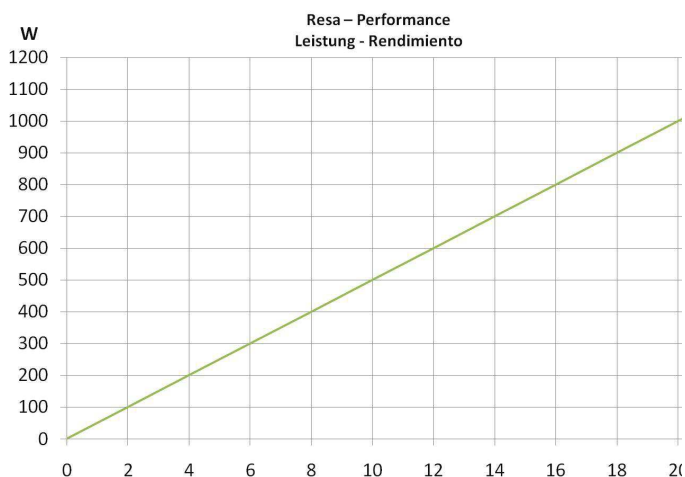
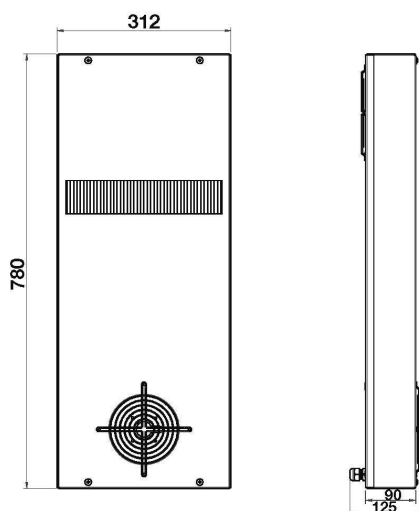

CODE - CODICE - MODEL - CODIGO	M.U.	XVA5000320	XVA50T0120	XVA50T0220	XVA50U1320	XVA50U1303
Power supply - Alimentazione - Spannungsversorgung - Tensión	V - ph - Hz	230-1-50/60	230-1-50/60	230-1-50/60	230-1-60	115-1-60
Specific heat transmission - Resa específica Spezifische Leistung - Rendimiento específico	W/K	50	50	50	50	50
Height / Wicht / Depth - Altezza / Larghezza / Profondità Höhe / Breite / Tiefe - Altura / Ancho / Profundidad	mm	780x312x90	780x312x90	780x312x90	780x312x90	780x312x90
Absorbed current - Corrente assorbita - Stromaufnahme - Corriente absorbida	A	0,72	0,72	0,72	0,8	1,4
Pre-Fuse T - Fusibile T - Absicherung T - Elemento previo de fusibile T	A	2	2	2	2	4
Power consumption - Potenza assorbita - Leistungaufnahme - Potencia absorbida	W	160	160	160	150	180
Side cabinet fan flow, free blowing - Portata aria ventil. lato armadio, bocca libera Luftmenge Schrankseite, freiblasend - Caudal. aire ventil. Lado armario	m3/h	575	575	575	575	575
Regulation Temperature limits - Limiti di regolazione Temperatura Temperatur Einstellbereich - límites de ajuste de Temperatura	°C	-5 / +55	-5 / +55	-5 / +55	-5 / +55	-5 / +55
Side ambient Temperature limits - Limiti di Temperatura lato ambiente Umgebungstemperatur - Límites Temperatura lado ambiente	°C	-5 / +55	-5 / +55	-5 / +55	-5 / +55	-5 / +55
Side cabinet protection degree - Protezione lato armadio Schutzgrad Schrankseite - Protección lado armario	IP/Type	55	55	55	54/12	54/12
Noise level - Rumorosità - Geräuschpegel - Nivel de ruido	dB(A)	76	76	76	76	76
Weight - Peso - Gewicht - Peso	kg	9,5	9,5	9,5	9,5	9,5
Installation - Installazione - Installation - Instalación		Internal / External	Internal	External	Internal/External	Internal/External
Mechanical Thermostat - Termostato Meccanico - Mechanischer Thermostat - Termostato mecánico		No	Yes	Yes	No	No

OPTIONAL

Special Colour - Colore Speciale OCAXNS03
Stainless Steel Housing - Carpentaria Inox AISI304 OCAXI02

Unità 230 V UL può funzionare anche a 50 Hz
230V UL unit can work with frequency 50 Hz



HEAT EXCHANGERS - SCAMBIATORI DI CALORE - WÄRMETAUSCHER - INTERCAMBIADORES DE CALOR
INDOOR - X LINE XVA



XVA XVA90

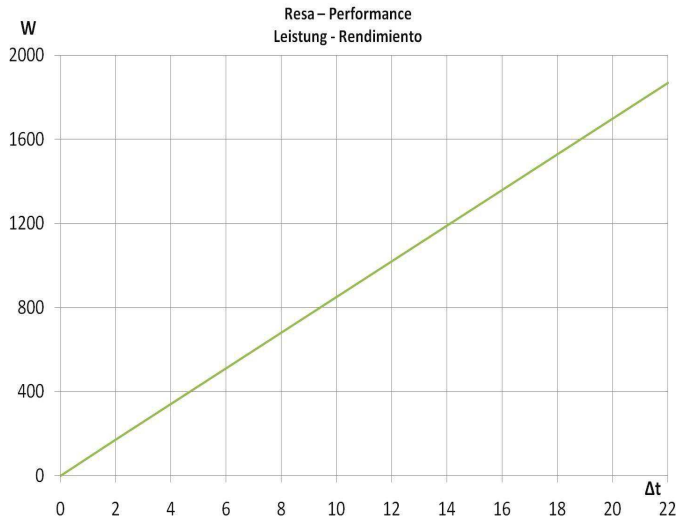
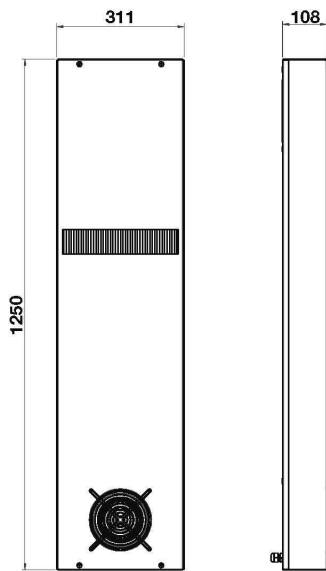

EXTERNAL INSTALLATION

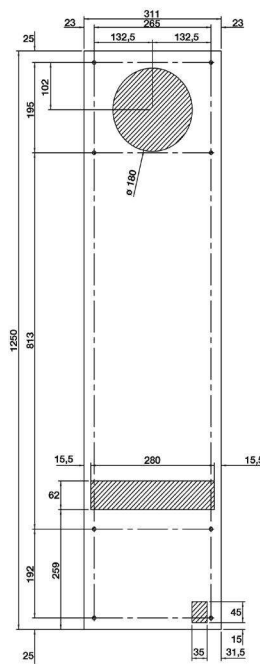

INTERNAL INSTALLATION

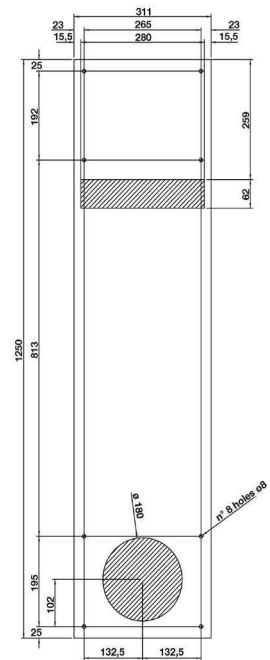

CODE - CODICE - MODEL - CODIGO	M.U.	XVA90T0120	XVA90T0220
Power supply - Alimentazione - Spannungsversorgung - Tensión	V - ph - Hz	230-1-50/60	230-1-50/60
Specific heat transmission - Resa specifica Spezifische Leistung - Rendimiento específico	W/K	85	85
Height / Widht / Depth - Altezza / Larghezza / Profondità Höhe / Breite / Tiefe - Altura / Ancho / Profundidad	mm	1250x311x108	1250x311x108
Absorbed current - Corrente assorbita - Stromaufnahme - Corriente absorbida	A	1	1
Pre-Fuse T - Fusibile T - Absicherung T - Elemento previo de fusibile T	A	1,5	1,5
Power consumption - Potenza assorbita - Leistungaufnahme - Potencia absorbida	W	340	340
Side cabinet fan flow, free blowing - Portata aria ventil. lato armadio, bocca libera Luftmenge Schrankseite, freiblasend - Caudal aire ventil. Lado armario	m ³ /h	1050	1050
Regulation Temperature limits - Limiti di regolazione Temperatura Temperatur Einstellbereich - limites de ajuste de Temperatura	°C	-5 / +55	-5 / +55
Side ambient Temperature limits - Limiti di Temperatura lato ambiente Umgebungstemperatur - Limites Temperatura lado ambiente	°C	-5 / +55	-5 / +55
Side cabinet protection degree - Protezione lato armadio Schutzgrad Schrankseite - Protección lado armario	IP	55	55
Noise level - Rumorosità - Geräuschpegel - Nivel de ruido	dB(A)	75	75
Weight - Peso - Gewicht - Peso	kg	20	20
Installation - Installazione - Installation - Instalación		Internal	External
Mechanical Thermostat - Termostato Meccanico - Mechanischer Thermostat - Termostato mecánico		Yes	Yes

OPTIONAL

Special Colour - Colore Speciale OCAXNS01
Stainless Steel Housing - Carpentaria Inox AISI304 OCAXIO3

HEAT EXCHANGERS - SCAMBIATORI DI CALORE - WÄRMETAUSCHER - INTERCAMBIADORES DE CALOR
INDOOR - X LINE XVA