

| CKT NO | PART NO | DIM A |
|--------|-------------|---|
| 2 | 170001-0102 | 8.35 |
| 4 | 170001-0104 | 12.05 |
| 6 | 170001-0106 | 17.75 |
| 8 | 170001-0108 | 23.45 ^{+0.40} _{-0.25} |
| 10 | 170001-0110 | 29.15 ^{+0.40} _{-0.25} |
| 12 | 170001-0112 | 34.85 ^{+0.40} _{-0.25} |

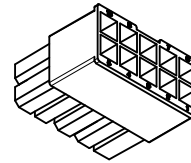

170001-0110

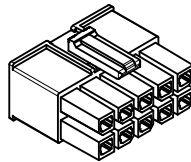
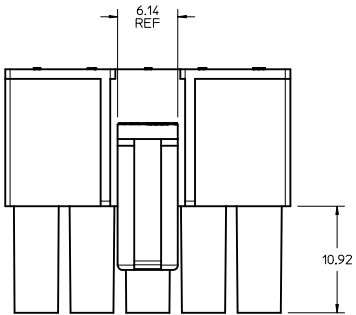
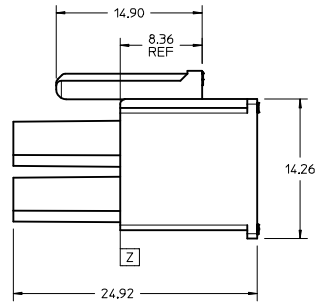
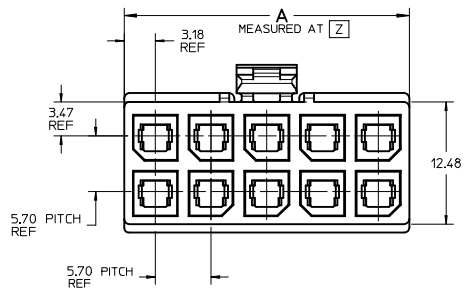

NOTES:

1. MATERIAL:
HOUSING: NYLON, GLOW WIRE CAPABLE PER IEC-60335-1. COLOR: BLACK.
2. PRODUCT SPECIFICATION PS-76823-100.
3. PART MATES WITH MOLEX SERIES NUMBER 76825, 172064, 76829 AND 172065.
4. PACKAGING BULK PACK PER PK-170001-001.
5. PART IS FOR USE WITH MOLEX FEMALE TERMINALS 76823 OR 172063 SERIES.
6. PARTS CONFORM TO CLASS "B" REQUIREMENTS OF COSMETIC SPECIFICATION PS-45499-002 WITH THE EXCEPTION OF DISCOLORATION MEET CLASS "C" REQUIREMENTS.

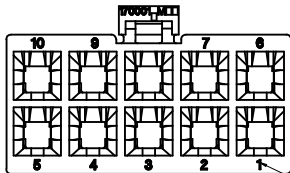
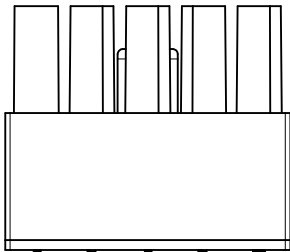

CIRCUIT #

| | | | | | | | | | |
|--|--------------------------------------|---|--------------------|--|-------------------|----------------------------------|--|---------------------------------------|--|
| UPDATE NOTES IEC NO: UCP2014-2917 DRAWN BY: DRVANKOVEN CHKD: BELL APPR: SMITH 2014/01/27 2014/01/27 2014/01/28 | QUALITY SYMBOLS ∇=0 ∇=0 ∇=0 | GENERAL TOLERANCES (UNLESS SPECIFIED) | | DIMENSION STYLE MM ONLY | | SCALE 4:1 | DESIGN UNITS METRIC | THIRD ANGLE PROJECTION | |
| | | 4 PLACES ±--- ±--- | 3 PLACES ±--- ±--- | 2 PLACES ±0.25 ±--- | 1 PLACE ±--- ±--- | 0 PLACE ± ± | DRAWN BY: MKARADIMAS DATE: 2010/11/23 | CHECKED BY: DATE | TITLE MEGA-FIT RECEPTACLE HOUSING 2-12 CKT |
| | | ANGULAR ±1/2° | | DRAFT WHERE APPLICABLE MUST REMAIN WITHIN DIMENSIONS | | MATERIAL NO. SEE CHART | APPROVED BY: APATEL DATE: 2012/06/13 | DOCUMENT NO. SD-170001-0100 | SHEET NO. 1 OF 2 |
| | | THIS DRAWING CONTAINS INFORMATION THAT IS PROPRIETARY TO MOLEX INCORPORATED AND SHOULD NOT BE USED WITHOUT WRITTEN PERMISSION | | | | | | | |

20 19 18 17 16 15 14 13 12 11 10 9 8 7 6 5 4 3 2 1

2 CKTS

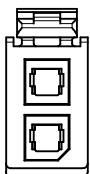

4 CKT

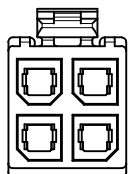

6 CKT

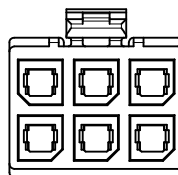

8 CKT

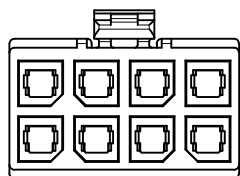

10 CKTS

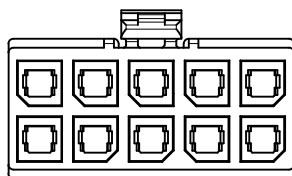

12 CKTS

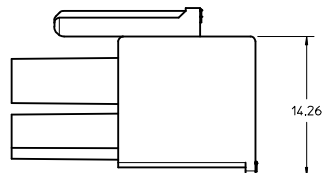
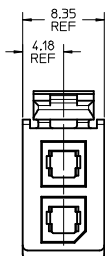
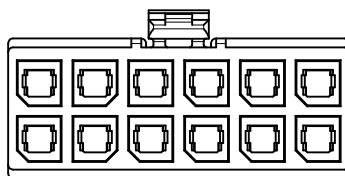

170001-0102

| | | | | | | | | | |
|---|--------------------------------------|---|--------------|---------------------------------------|---------------------|--|------------------------|--|--|
| SEE SHT 1 IEC NO: UCP2014-2917 DRAWING NO: 2014/01/27 CHKD: J.BELL APPR: F.S.MITH 2014/01/28 | QUALITY SYMBOLS ▽=0 ▽=0 ▽=0 | GENERAL TOLERANCES (UNLESS SPECIFIED) | | DIMENSION STYLE MM ONLY | SCALE 4:1 | DESIGN UNITS METRIC | THIRD ANGLE PROJECTION | | |
| | | 4 PLACES ± --- ± --- 3 PLACES ± --- ± --- 2 PLACES ± 0.25 ± --- 1 PLACE ± --- ± --- 0 PLACE ± ± | mm INCH | DRAWN BY MKARADIMAS | DATE 2010/11/23 | TITLE MEGA-FIT RECEPTACLE HOUSING 2-12 CKT | | | |
| | | ANGULAR ±1/2° DRAFT WHERE APPLICABLE MUST REMAIN WITHIN DIMENSIONS | | APPROVED BY APATEL | DATE 2012/06/13 | MATERIAL NO. SEE CHART | | | |
| | | | | DOCUMENT NO. SD-170001-0100 | | SHEET NO. 2 OF 2 | | | |

19 18 17 16 15 14 13 12 11 10 9 8 7 6 5 4 3 2 1

| CKT NO | PART NO | DIM A |
|--------|-------------|-------------|
| 2 | 171692-0102 | 8.35 |
| 4 | 171692-0104 | 12.05 |
| 6 | 171692-0106 | 17.75 |
| 8 | 171692-0108 | 23.45 +0.40 |
| 10 | 171692-0110 | 29.15 +0.40 |
| 12 | 171692-0112 | 34.85 +0.40 |

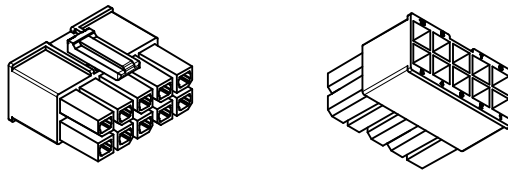

171692-0110

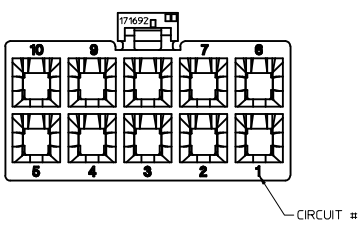
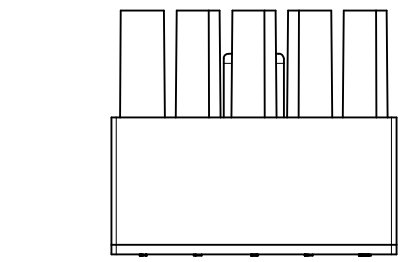
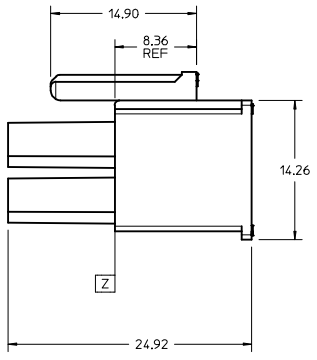
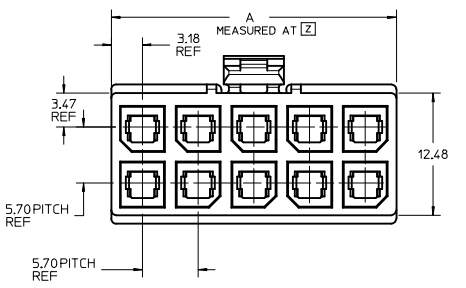
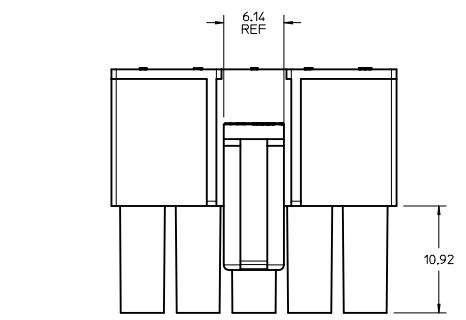

CIRCUIT #

NOTES:

- MATERIAL:
HOUSING: PBT, UL 94V-0, COLOR: BLACK
- PRODUCT SPECIFICATION: PS-76823-100.
- PART MATES WITH MOLEX SERIES NUMBERS 76825, 76829, 172064, AND 172065.
- PART IS FOR USE WITH MOLEX FEMALE TERMINAL 76823 OR 172063 SERIES.
- PARTS CONFORM TO CLASS B REQUIREMENTS OF COSMETIC SPECIFICATION PS-45499-002.
- PACKAGING: BULK PACK PER PK-170001-001.

| | | | | | | |
|--|--|---------------------------------------|----------------------|---------------------|---|------------------------|
| UPDATE MATERIAL IEC NO: UCP2014-0527 DRAWN BY: DRWANNUNGVEN CHECKED BY: CHKD.BELL APPROVED BY: APPRESMITH DATE: 2013/09/17 DATE: 2013/09/23 REV: A5 | QUALITY SYMBOLS | GENERAL TOLERANCES (UNLESS SPECIFIED) | DIMENSION STYLE | SCALE | DESIGN UNITS | THIRD ANGLE PROJECTION |
| | ▽=0 | mm INCH | MM ONLY | 4:1 | METRIC | |
| | ▽=0 | 4 PLACES ± --- + --- | DRAWN BY: MKARADIMAS | DATE: 2012/08/01 | TITLE: MEGA-FIT RECEPTACLE HOUSING 2-12 CKT | |
| | ▽=0 | 3 PLACES ± --- + --- | CHECKED BY: A.PATEL | DATE: 2012/08/17 | MATERIAL NO. SD-171692-0100 | |
| | 2 PLACES ± 0.25 + --- + --- | 1 PLACE ± --- + --- | 0 PLACE ± --- + --- | APPROVED BY: APATEL | DATE: 2012/08/17 | SHEET NO. 1 OF 2 |
| | ANGULAR ± 1/2° | | SEE CHART | | THIS DRAWING CONTAINS INFORMATION THAT IS PROPRIETARY TO MOLEX INCORPORATED AND SHOULD NOT BE USED WITHOUT WRITTEN PERMISSION | |
| | DRAFT WHERE APPLICABLE MUST REMAIN WITHIN DIMENSIONS | | | | | |

20 19 18 17 16 15 14 13 12 11 10 9 8 7 6 5 4 3 2 1

2 CKTS

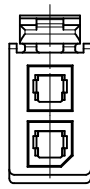

4 CKT

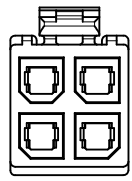

6 CKT

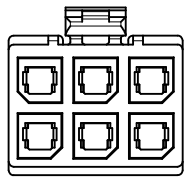

8 CKT

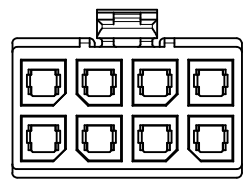

10 CKTS

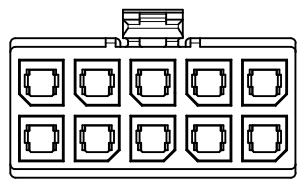

12 CKTS

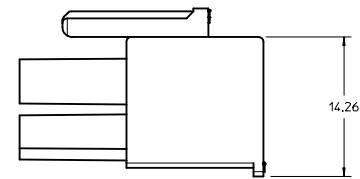
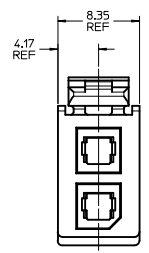
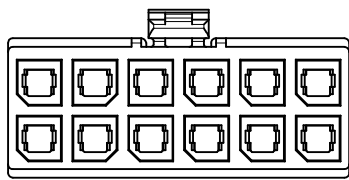

171692-0102

| | | | | | | | | | |
|---|--------------------------------------|--|------------|-----------------------------------|---------------------|--|---------------------------------------|---------------------|--|
| SEE SHT 1 IEC NO: UCP2014-0527 DRAWING NO: 2013/09/17 CHYK:J.BELL APPR:FSM TH 2013/09/17 2013/09/23 | QUALITY SYMBOLS ▽=0 ▽=0 ▽=0 | GENERAL TOLERANCES (UNLESS SPECIFIED) | | DIMENSION STYLE MM ONLY | SCALE 4:1 | DESIGN UNITS METRIC | THIRD ANGLE PROJECTION | | |
| | | 4 PLACES ±0.25 3 PLACES ±0.25 2 PLACES ±0.25 1 PLACE ±0.25 0 PLACE ±0.25 | mm INCH | DRAWN BY MKARADIMAS | DATE 2012/08/01 | TITLE MEGA-FIT RECEPTACLE HOUSING 2-12 CKT | | | |
| | | ANGULAR ±1/2° DRAFT WHERE APPLICABLE MUST REMAIN WITHIN DIMENSIONS | | APPROVED BY APATEL | DATE 2012/08/17 | MATERIAL NO. SEE CHART | DOCUMENT NO. SD-171692-0100 | SHEET NO. 2 OF 2 | |

19 18 17 16 15 14 13 12 11 10 9 8 7 6 5 4 3 2 1