

KR FAMILY SERIES/KRW·KR·PHN·TR CONNECTOR

2.0mm pitch/Disconnectable Insulation displacement and Crimp style connectors

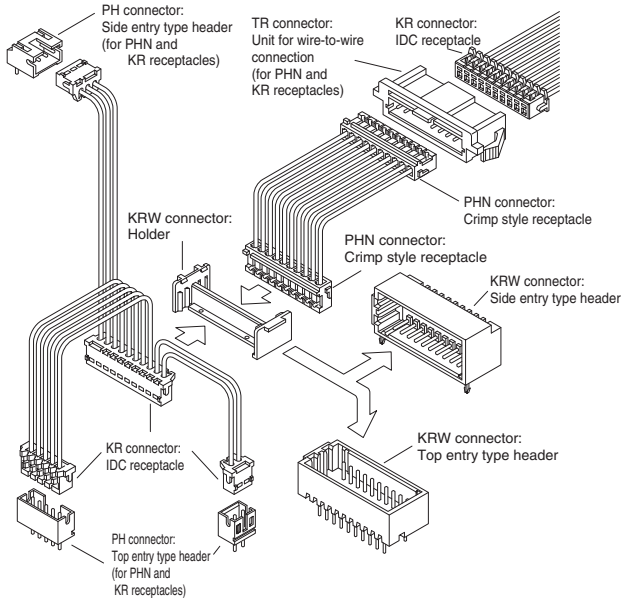

Based upon JST's field proven KR series connectors, the KR series family of connectors have been expanded to meet the requirements of high density packaging. The KRW connector allows double-row wire-to-board connection using either the KR or PHN connectors. Whilst the TR connector allows wire-to-wire connection, also using either the KR or PHN connectors.

- Multi-IDC-harnesses are possible
- Various types of connectors
- Cost reduction
- Two types of circuit layouts

Specifications

Item	Series	KRW connector	TR · TRW connector
Current rating		1.0A AC,DC (AWG#26)	
Voltage rating		100V AC,DC	
Temperature rise		-25°C to +85°C (including temperature rise)	
Contact resistance		initial/10mΩmax. After environmental testing/20mΩmax.	
Insulation resistance		1,000MΩmin.	
Withstanding voltage		800V AC/minute	
Applicable connector		KR connector, CR connector, PHN connector	
Applicable PC board thickness		1.6mm	—
Applicable panel thickness		—	0.5mm to 2.0mm

- * Compliant with RoHS.
- * Refer to "General Instruction and Notice when using Terminals and Connectors" at the end of this catalog.
- * Contact JST for details.

Standards

- Ⓜ Recognized E60389
- Ⓢ Certified LR20812
- △ R75087: PH, PHN connectors
- △ R75088: KR connector
- △ R9851222: KRW connector
- △ R9851223: TR connector

PC board layout and Assembly layout

Single-row shrouded header

<Through-hole type(viewed from component side)>

Top entry type

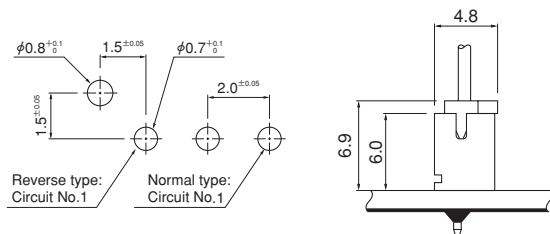

Side entry type

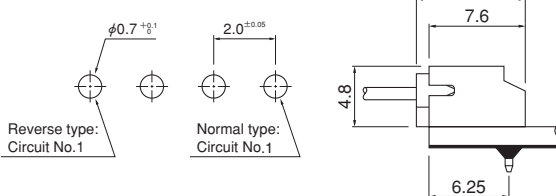

Note: 1. Tolerances are non-cumulative: ±0.05mm for all centers.
2. Hole dimensions differ according to the kind of PC board and piercing method. The dimensions above should serve as a guideline. Contact JST for details.

<SMTtype(viewed from soldering side)>

Top entry type

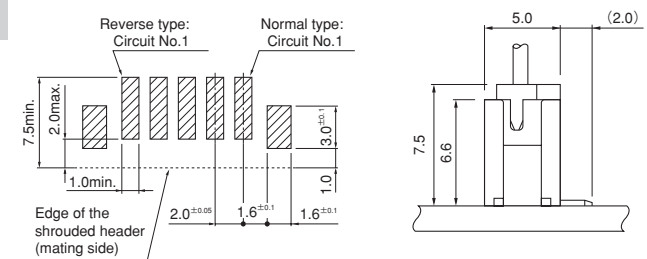

Side entry type

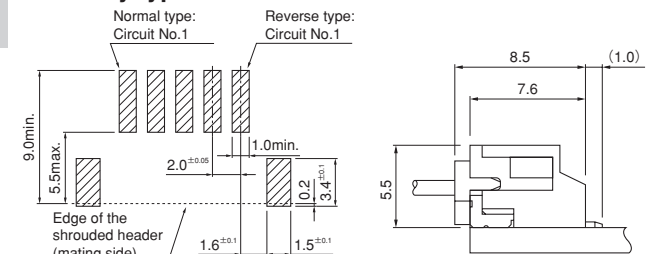

Note: 1. Tolerances are non-cumulative: ±0.05mm for all centers.
2. The dimensions above should serve as a guideline. Contact JST for details.

KR FAMILY SERIES/KRW·KR·PHN·TR CONNECTOR

Double-row shrouded header (viewed from component side)

Top entry type

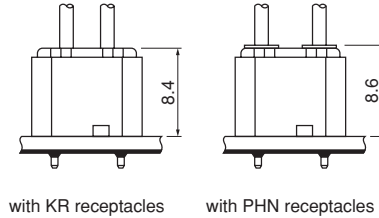
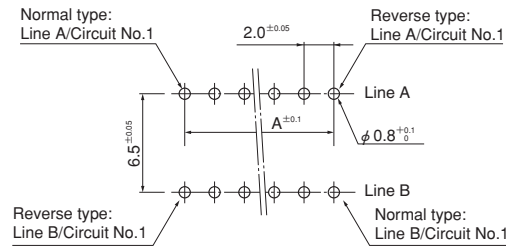

With locks

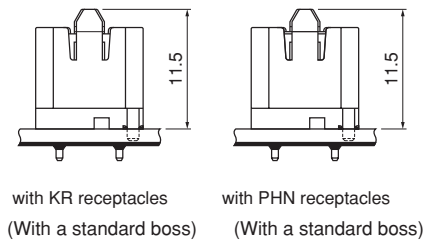
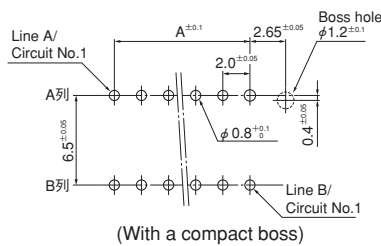
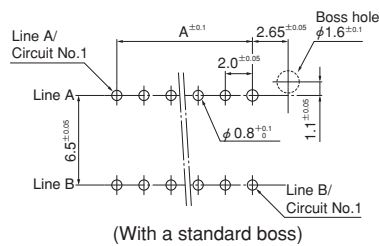

Side entry type

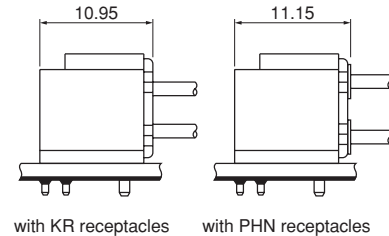
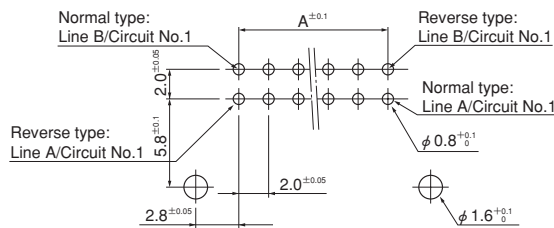

Note: 1. Tolerances are non-cumulative: ±0.05mm for all centers.

2. Hole dimensions differ according to the kind of PC board and piercing method. The dimensions above should serve as a guideline. Contact JST for details.

Insulation displacement connector (Receptacle)

(2 to 12 circuits)

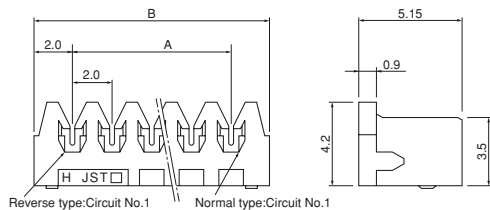

(13 to 16 circuits)

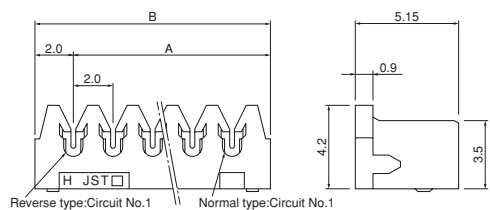

Circuits	Model No.		Dimensions (mm)		Q'ty / box
	Normal type	Reverse type	A	B	
2	02KR-6H-P	02KR-6H-PC	2.0	6.0	2,000
3	03KR-6H-P	03KR-6H-PC	4.0	8.0	2,000
4	04KR-6H-P	04KR-6H-PC	6.0	10.0	2,000
5	05KR-6H-P	05KR-6H-PC	8.0	12.0	2,000
6	06KR-6H-P	06KR-6H-PC	10.0	14.0	2,000
7	07KR-6H-P	07KR-6H-PC	12.0	16.0	1,000
8	08KR-6H-P	08KR-6H-PC	14.0	18.0	1,000
9	09KR-6H-P	09KR-6H-PC	16.0	20.0	1,000
10	10KR-6H-P	10KR-6H-PC	18.0	22.0	1,000
11	11KR-6H-P	11KR-6H-PC	20.0	24.0	1,000
12	12KR-6H-P	12KR-6H-PC	22.0	26.0	1,000
13	13KR-6H-P	13KR-6H-PC	24.0	28.0	500
14	14KR-6H-P	14KR-6H-PC	26.0	30.0	500
15	15KR-6H-P	15KR-6H-PC	28.0	32.0	500
16	16KR-6H-P	16KR-6H-PC	30.0	34.0	500

Material and Finish

Contact: Phosphor bronze, tin-plated (reflow treatment)
Housing: 2 to 12 circuits...PA 66, UL94V-0, gray
13 to 16 circuits...Glass-filled PA 66, UL94V-0, gray

Applicable wire

UL1571, 1061(Contact JST for other UL styles.)
AWG#28, #26
Conductor / 7 strands, tin-plated annealed copper
Insulation O.D. / 0.9 to 1.0mm

RoHS compliance

KR FAMILY SERIES/KRW·KR·PHN·TR CONNECTOR

Crimp style connector (Contact)

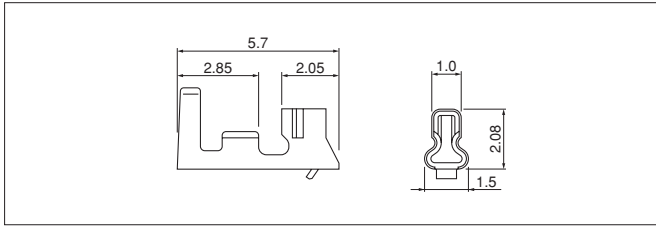

Model No.	Applicable wire		Insulation O.D. (mm)	Q'ty / reel
	mm ²	AWG#		
SPH-002T-P0.5L	0.08~0.22	28~24	0.8~1.5	8,000

Material and Finish

Phosphor bronze, tin-plated (reflow treatment)

RoHS compliance

Note: SPH-002T-P0.5S is also available.

Contact	Crimping machine	Applicator		
		Crimp applicator	Dies	Crimp applicator with dies
SPH-002T-P0.5L	AP-K2N	MKS-LS · MKS-L	MK/SPH-002-05L	APLMK SPH002-05L
		*MKS-SC	SC/SPH-002-05L	APLSC SPH002-05L

Note: *Strip-crimp applicator

Crimp style connector (Housing)

Normal type (2 circuits)

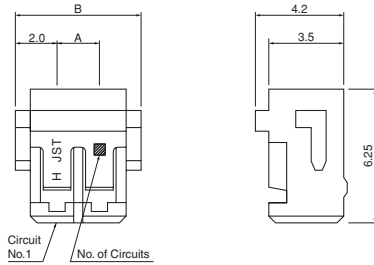

(3 to 16 circuits)

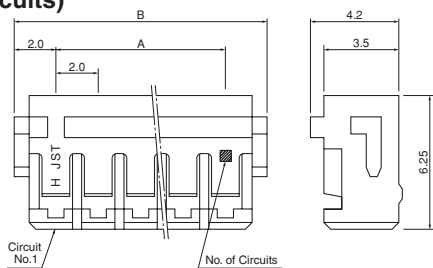

Reverse type (2 circuits)

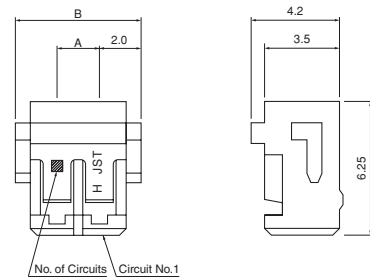

(3 to 16 circuits)

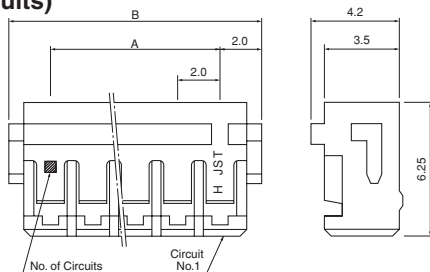

Circuits	Model No.		Dimensions (mm)		Q'ty / bag
	Normal type	Reverse type	A	B	
2	PHNR-02-H	PHNR-02C-H	2.0	6.0	1,000
3	PHNR-03-H	PHNR-03C-H	4.0	8.0	1,000
4	PHNR-04-H	PHNR-04C-H	6.0	10.0	1,000
5	PHNR-05-H	PHNR-05C-H	8.0	12.0	1,000
6	PHNR-06-H	PHNR-06C-H	10.0	14.0	1,000
7	PHNR-07-H	PHNR-07C-H	12.0	16.0	1,000
8	PHNR-08-H	PHNR-08C-H	14.0	18.0	1,000
9	PHNR-09-H	PHNR-09C-H	16.0	20.0	1,000
10	PHNR-10-H	PHNR-10C-H	18.0	22.0	1,000
11	PHNR-11-H	PHNR-11C-H	20.0	24.0	1,000
12	PHNR-12-H	PHNR-12C-H	22.0	26.0	1,000
13	PHNR-13-H	PHNR-13C-H	24.0	28.0	1,000
14	PHNR-14-H	PHNR-14C-H	26.0	30.0	1,000
15	PHNR-15-H	PHNR-15C-H	28.0	32.0	1,000
16	PHNR-16-H	PHNR-16C-H	30.0	34.0	1,000

Material

PA 66, UL94V-0, gray

RoHS compliance

KR FAMILY SERIES/KRW·KR·PHN·TR CONNECTOR

Single-row shrouded header (Through-hole type)

Top entry type

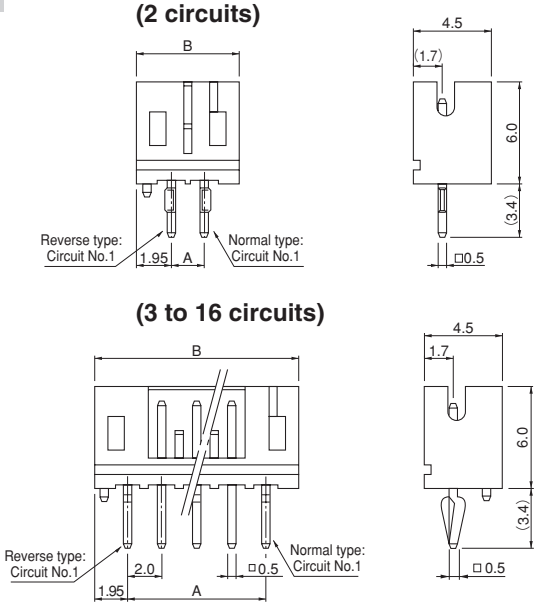

Side entry type

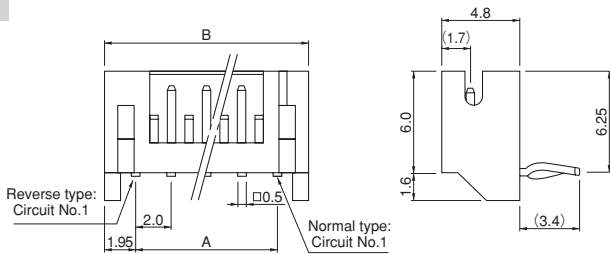

Circuits	Normal type Model No.		Dimensions (mm)		Q'ty / box	
	Top entry type (with boss)	Side entry type	A	B	Top entry type (with a boss)	Side entry type
2	B2B-PH-KBL-H	S2B-PH-KL	2.0	5.9	1,000	1,000
3	B3B-PH-KBL-H	S3B-PH-KL	4.0	7.9	1,000	1,000
4	B4B-PH-KBL-H	S4B-PH-KL	6.0	9.9	1,000	500
5	B5B-PH-KBL-H	S5B-PH-KL	8.0	11.9	1,000	500
6	B6B-PH-KBL-H	S6B-PH-KL	10.0	13.9	1,000	500
7	B7B-PH-KBL-H	S7B-PH-KL	12.0	15.9	500	500
8	B8B-PH-KBL-H	S8B-PH-KL	14.0	17.9	500	250
9	B9B-PH-KBL-H	S9B-PH-KL	16.0	19.9	500	250
10	B10B-PH-KBL-H	S10B-PH-KL	18.0	21.9	500	250
11	B11B-PH-KBL-H	S11B-PH-KL	20.0	23.9	500	250
12	B12B-PH-KBL-H	S12B-PH-KL	22.0	25.9	500	250
13	B13B-PH-KBL-H	S13B-PH-KL	24.0	27.9	250	250
14	B14B-PH-KBL-H	S14B-PH-KL	26.0	29.9	250	200
15	B15B-PH-KBL-H	S15B-PH-KL	28.0	31.9	250	200
16	B16B-PH-KBL-H	S16B-PH-KL	30.0	33.9	250	200

Circuits	Reverse type Model No.		Dimensions (mm)		Q'ty / box	
	Top entry type (with boss)	Side entry type	A	B	Top entry type (with a boss)	Side entry type
2	B2B-PH-KBLC-H	S2B-PH-KLC-H	2.0	5.9	1,000	1,000
3	B3B-PH-KBLC-H	S3B-PH-KLC-H	4.0	7.9	1,000	1,000
4	B4B-PH-KBLC-H	S4B-PH-KLC-H	6.0	9.9	1,000	500
5	B5B-PH-KBLC-H	S5B-PH-KLC-H	8.0	11.9	1,000	500
6	B6B-PH-KBLC-H	S6B-PH-KLC-H	10.0	13.9	1,000	500
7	B7B-PH-KBLC-H	S7B-PH-KLC-H	12.0	15.9	500	500
8	B8B-PH-KBLC-H	S8B-PH-KLC-H	14.0	17.9	500	250
9	B9B-PH-KBLC-H	S9B-PH-KLC-H	16.0	19.9	500	250
10	B10B-PH-KBLC-H	S10B-PH-KLC-H	18.0	21.9	500	250
11	B11B-PH-KBLC-H	S11B-PH-KLC-H	20.0	23.9	500	250
12	B12B-PH-KBLC-H	S12B-PH-KLC-H	22.0	25.9	500	250
13	B13B-PH-KBLC-H	S13B-PH-KLC-H	24.0	27.9	250	250
14	B14B-PH-KBLC-H	S14B-PH-KLC-H	26.0	29.9	250	200
15	B15B-PH-KBLC-H	S15B-PH-KLC-H	28.0	31.9	250	200
16	B16B-PH-KBLC-H	S16B-PH-KLC-H	30.0	33.9	250	200

Material and Finish

Post: Copper alloy, copper-undercoated, tin-plated (reflow treatment)
Wafer: PA 66, UL94V-0, gray

RoHS compliance This product displays (LF)(SN) on a label.
Note: Top entry type headers without a boss are also available.

<For reference> As the color identification, the following alphabet shall be put in the underlined part.
For availability, delivery and minimum order quantity, contact JST.

ex. **B2B-PH-KBLC-H**

H...gray S...white Y...yellow R...red N...brown
K...black (blank)...gray (normal side entry type only)

KR FAMILY SERIES/KRW·KR·PHN·TR CONNECTOR

Single-row shrouded header (SMT type)

Top entry type

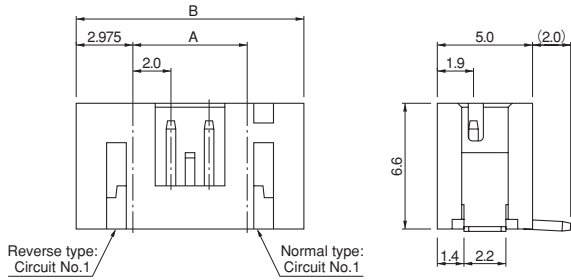

Side entry type

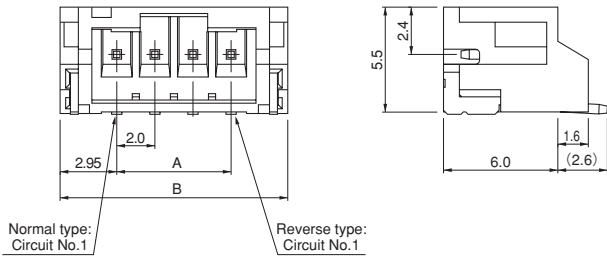

Circuits	Normal type Model No.		Dimensions (mm)			Q'ty / reel
	Top entry type	Side entry type	A	B		
				Top entry type	Side entry type	
2	B2B-PH-SM4-TB	S2B-PH-SM4-TB	2.0	7.95	7.9	1,000
3	B3B-PH-SM4-TB	S3B-PH-SM4-TB	4.0	9.95	9.9	1,000
4	B4B-PH-SM4-TB	S4B-PH-SM4-TB	6.0	11.95	11.9	1,000
5	B5B-PH-SM4-TB	S5B-PH-SM4-TB	8.0	13.95	13.9	1,000
6	B6B-PH-SM4-TB	S6B-PH-SM4-TB	10.0	15.95	15.9	1,000
7	B7B-PH-SM4-TB	S7B-PH-SM4-TB	12.0	17.95	17.9	1,000
8	B8B-PH-SM4-TB	S8B-PH-SM4-TB	14.0	19.95	19.9	1,000
9	B9B-PH-SM4-TB	S9B-PH-SM4-TB	16.0	21.95	21.9	1,000
10	B10B-PH-SM4-TB	S10B-PH-SM4-TB	18.0	23.95	23.9	1,000
11	B11B-PH-SM4-TB	S11B-PH-SM4-TB	20.0	25.95	25.9	1,000
12	B12B-PH-SM4-TB	S12B-PH-SM4-TB	22.0	27.95	27.9	1,000
13	B13B-PH-SM4-TB	S13B-PH-SM4-TB	24.0	29.95	29.9	1,000
14	B14B-PH-SM4-TB	S14B-PH-SM4-TB	26.0	31.95	31.9	1,000
15	B15B-PH-SM4-TB	S15B-PH-SM4-TB	28.0	33.95	33.9	1,000
16	B16B-PH-SM4-TB	—	30.0	35.95	—	1,000

Material and Finish

Post: Copper alloy, copper-undercoated, tin-plated (reflow treatment)
 Wafer: PA 6T, UL94V-0, natural (ivory)
 Solder tab: Brass, copper-undercoated, tin-plated (reflow treatment)

RoHS compliance This product displays (LF)(SN) on a label.
 Note: Top entry type headers with suction tape are also available.

Circuits	Reverse type Model No.		Dimensions (mm)		Q'ty / reel
	Top entry type	Side entry type	A	B	
2	B2B-PH-SM4C-TB	S2B-PH-SM4C-TB	2.0	7.9	1,000
3	B3B-PH-SM4C-TB	S3B-PH-SM4C-TB	4.0	9.9	1,000
4	B4B-PH-SM4C-TB	S4B-PH-SM4C-TB	6.0	11.9	1,000
5	B5B-PH-SM4C-TB	S5B-PH-SM4C-TB	8.0	13.9	1,000
6	B6B-PH-SM4C-TB	S6B-PH-SM4C-TB	10.0	15.9	1,000
7	B7B-PH-SM4C-TB	S7B-PH-SM4C-TB	12.0	17.9	1,000
8	B8B-PH-SM4C-TB	S8B-PH-SM4C-TB	14.0	19.9	1,000
9	B9B-PH-SM4C-TB	S9B-PH-SM4C-TB	16.0	21.9	1,000
10	B10B-PH-SM4C-TB	S10B-PH-SM4C-TB	18.0	23.9	1,000
11	B11B-PH-SM4C-TB	S11B-PH-SM4C-TB	20.0	25.9	1,000
12	B12B-PH-SM4C-TB	S12B-PH-SM4C-TB	22.0	27.9	1,000
13	B13B-PH-SM4C-TB	S13B-PH-SM4C-TB	24.0	29.9	1,000
14	B14B-PH-SM4C-TB	S14B-PH-SM4C-TB	26.0	31.9	1,000
15	B15B-PH-SM4C-TB	S15B-PH-SM4C-TB	28.0	33.9	1,000
16	B16B-PH-SM4C-TB	—	30.0	35.9	1,000

Material and Finish

Post: Copper alloy, copper-undercoated, tin-plated (reflow treatment)
 Wafer: PA 6T, UL94V-0, natural (ivory)
 Solder tab: Brass, copper-undercoated, tin-plated (reflow treatment)

RoHS compliance This product displays (LF)(SN) on a label.

KR FAMILY SERIES/KRW·KR·PHN·TR CONNECTOR

Double-row shrouded Header

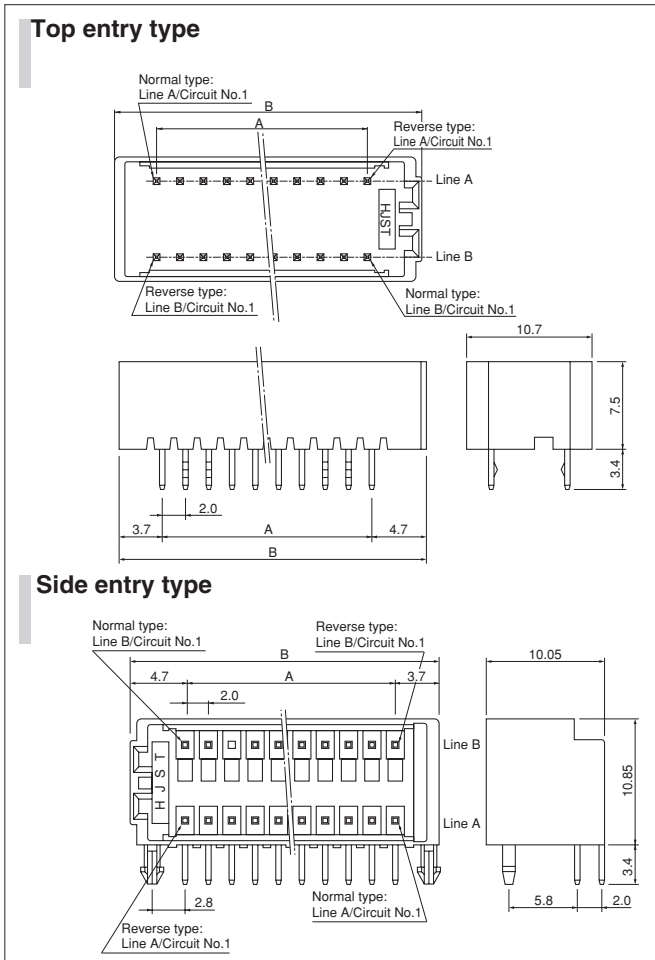

Circuits	Model No.				Dimensions (mm)		Q'ty / box	
	Normal type		Reverse type		A	B	Top entry type	Side entry type
	Top entry type	Side entry type	Top entry type	Side entry type				
10	B10B-KRWHK	—	B10B-KRWHK-C	—	8.0	16.4	416	—
12	B12B-KRWHK	—	B12B-KRWHK-C	—	10.0	18.4	384	—
14	B14B-KRWHK	—	B14B-KRWHK-C	—	12.0	20.4	352	—
16	B16B-KRWHK	S16B-KRWHS	B16B-KRWHK-C	S16B-KRWHS-C	14.0	22.4	320	280
18	B18B-KRWHK	S18B-KRWHS	B18B-KRWHK-C	S18B-KRWHS-C	16.0	24.4	288	252
20	B20B-KRWHK	S20B-KRWHS	B20B-KRWHK-C	S20B-KRWHS-C	18.0	26.4	256	224
22	B22B-KRWHK	S22B-KRWHS	B22B-KRWHK-C	S22B-KRWHS-C	20.0	28.4	224	196
24	B24B-KRWHK	S24B-KRWHS	B24B-KRWHK-C	S24B-KRWHS-C	22.0	30.4	224	196
26	B26B-KRWHK	S26B-KRWHS	B26B-KRWHK-C	S26B-KRWHS-C	24.0	32.4	192	168
28	B28B-KRWHK	S28B-KRWHS	B28B-KRWHK-C	S28B-KRWHS-C	26.0	34.4	192	168
30	B30B-KRWHK	S30B-KRWHS	B30B-KRWHK-C	S30B-KRWHS-C	28.0	36.4	192	168
32	B32B-KRWHK	S32B-KRWHS	B32B-KRWHK-C	S32B-KRWHS-C	30.0	38.4	160	140

Material and Finish

Post: Copper alloy, copper-undercoated, tin-plated (reflow treatment)
Wafer: PA 66, UL94V-0, gray

RoHS compliance This product displays (LF)(SN) on a label.

Note:1. Top entry type headers with bosses or without clinched tails are also available.

2. The products listed above are supplied packed in tray.

<For reference> As the color identification,

the following alphabet shall be put in the underlined part.

For availability, delivery and minimum order quantity, contact JST.

ex. **B10B-KRWHK(-)**

M...green H...gray N...brown

Double-row shrouded Header (with locks)

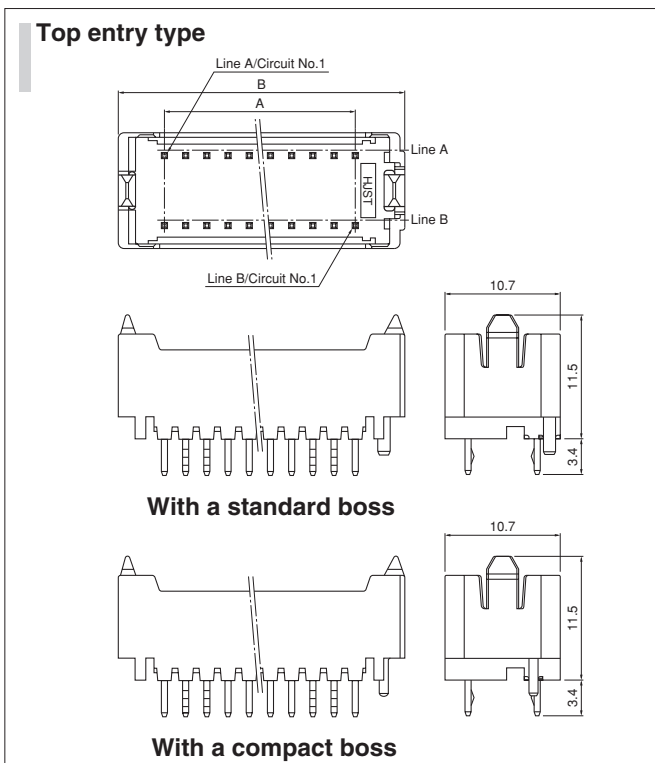

Circuits	Model No.			Dimensions (mm)		Q'ty / box
	Top entry type			A	B	
	Without bosses	With a standard boss	With a compact boss			
10	B10B-KRWHK-F1	B10B-KRWHK-F1-1	B10B-KRWHK-F1-1D	8.0	17.0	364
12	B12B-KRWHK-F1	B12B-KRWHK-F1-1	B12B-KRWHK-F1-1D	10.0	19.0	308
14	B14B-KRWHK-F1	B14B-KRWHK-F1-1	B14B-KRWHK-F1-1D	12.0	21.0	280
16	B16B-KRWHK-F1	B16B-KRWHK-F1-1	B16B-KRWHK-F1-1D	14.0	23.0	252
18	B18B-KRWHK-F1	B18B-KRWHK-F1-1	B18B-KRWHK-F1-1D	16.0	25.0	252
20	B20B-KRWHK-F1	B20B-KRWHK-F1-1	B20B-KRWHK-F1-1D	18.0	27.0	224
22	B22B-KRWHK-F1	B22B-KRWHK-F1-1	B22B-KRWHK-F1-1D	20.0	29.0	196
24	B24B-KRWHK-F1	B24B-KRWHK-F1-1	B24B-KRWHK-F1-1D	22.0	31.0	196
26	B26B-KRWHK-F1	B26B-KRWHK-F1-1	B26B-KRWHK-F1-1D	24.0	33.0	168
28	B28B-KRWHK-F1	B28B-KRWHK-F1-1	B28B-KRWHK-F1-1D	26.0	35.0	168
30	B30B-KRWHK-F1	B30B-KRWHK-F1-1	B30B-KRWHK-F1-1D	28.0	37.0	168
32	B32B-KRWHK-F1	B32B-KRWHK-F1-1	B32B-KRWHK-F1-1D	30.0	39.0	140

Material and Finish

Post: Copper alloy, copper-undercoated, tin-plated (reflow treatment)
Wafer: PA 66, UL94V-0, gray

RoHS compliance This product displays (LF)(SN) on a label.

Note:1. The products listed above are supplied packed in tray.

2. Not UL/CSA/TÜV approved.

3. The applicable holder is "KRWH-(-)(-1)" only.

<For reference> As the color identification,

the following alphabet shall be put in the underlined part.

For availability, delivery and minimum order quantity, contact JST.

ex. **B10B-KRWHK-F1(-)**

H...gray Y...yellow R...red N...brown

M...green...K...black

KR FAMILY SERIES/KRW·KR·PHN·TR CONNECTOR

KRW connector Holder

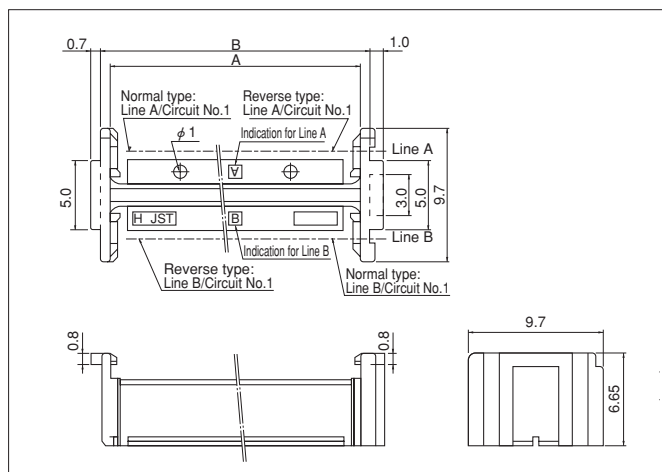

Circuits	Model No.		Dimensions (imm)	
	Normal type	Reverse type	A	B
10	KRWH-10-H	KRWH-10C-H	12.0	13.4
12	KRWH-12-H	KRWH-12C-H	14.0	15.4
14	KRWH-14-H	KRWH-14C-H	16.0	17.4
16	KRWH-16-H	KRWH-16C-H	18.0	19.4
18	KRWH-18-H	KRWH-18C-H	20.0	21.4
20	KRWH-20-H	KRWH-20C-H	22.0	23.4
22	KRWH-22-H	KRWH-22C-H	24.0	25.4
24	KRWH-24-H	KRWH-24C-H	26.0	27.4
26	KRWH-26-H	KRWH-26C-H	28.0	29.4
28	KRWH-28-H	KRWH-28C-H	30.0	31.4
30	KRWH-30-H	KRWH-30C-H	32.0	33.4
32	KRWH-32-H	KRWH-32C-H	34.0	35.4

Material

PA 66, UL94V-0, gray

RoHS compliance

KRW connector Holder (for header with locks)

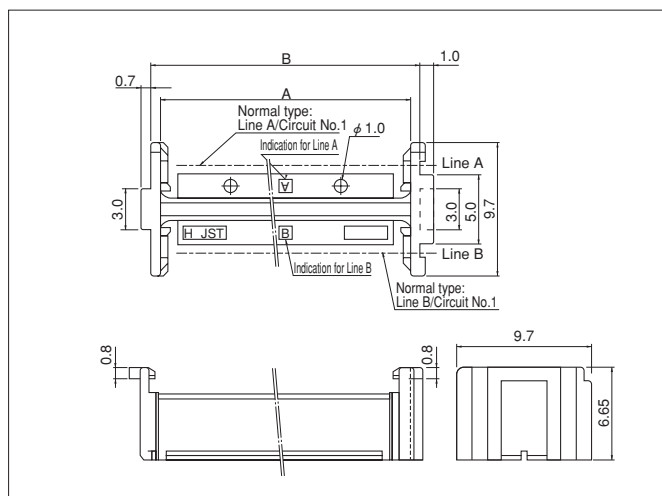

Circuits	Model No.	Dimensions (mm)		Q'ty / box
		A	B	
10	KRWH-10-H-1	12.0	13.4	1,000
12	KRWH-12-H-1	14.0	15.4	1,000
14	KRWH-14-H-1	16.0	17.4	1,000
16	KRWH-16-H-1	18.0	19.4	1,000
18	KRWH-18-H-1	20.0	21.4	1,000
20	KRWH-20-H-1	22.0	23.4	1,000
22	KRWH-22-H-1	24.0	25.4	1,000
24	KRWH-24-H-1	26.0	27.4	1,000
26	KRWH-26-H-1	28.0	29.4	1,000
28	KRWH-28-H-1	30.0	31.4	1,000
30	KRWH-30-H-1	32.0	33.4	1,000
32	KRWH-32-H-1	34.0	35.4	1,000

Material

PA 66, UL94V-0, gray

RoHS compliance

Note:1. Not UL/CSA/TÜV approved.

2. The applicable header is "B()B-KRW()K-F1-()" only.

<For reference> As the color identification, the following alphabet shall be put in the underlined part. For availability, delivery and minimum order quantity, contact JST.

ex. **KRWH-10-H-1**
H...gray Y...yellow R...red N...brown K...black S...natural

TR connector (Unit for wire-to-wire connection)

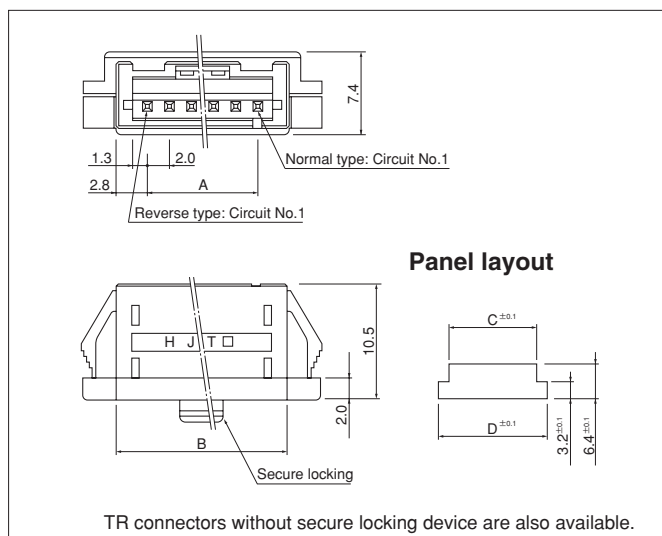

TR connectors without secure locking device are also available.

Circuits	Model No.		Dimensions (mm)				Q'ty / box
	Normal type	Reverse type	A	B	C	D	
2	BU02P-TR-P-H	BU02P-TR-PC-H	2.0	7.6	7.9	11.6	500
3	BU03P-TR-P-H	BU03P-TR-PC-H	4.0	9.6	9.9	13.6	500
4	BU04P-TR-P-H	BU04P-TR-PC-H	6.0	11.6	11.9	15.6	500
5	BU05P-TR-P-H	BU05P-TR-PC-H	8.0	13.6	13.9	17.6	250
6	BU06P-TR-P-H	BU06P-TR-PC-H	10.0	15.6	15.9	19.6	250
7	BU07P-TR-P-H	BU07P-TR-PC-H	12.0	17.6	18.0	21.6	200
8	BU08P-TR-P-H	BU08P-TR-PC-H	14.0	19.6	20.0	23.6	250
9	BU09P-TR-P-H	BU09P-TR-PC-H	16.0	21.6	22.0	25.6	250
10	BU10P-TR-P-H	BU10P-TR-PC-H	18.0	23.6	24.0	27.6	200
11	BU11P-TR-P-H	BU11P-TR-PC-H	20.0	25.6	26.0	29.6	200
12	BU12P-TR-P-H	BU12P-TR-PC-H	22.0	27.6	28.0	31.6	200
13	BU13P-TR-P-H	BU13P-TR-PC-H	24.0	29.6	30.0	33.6	150
14	BU14P-TR-P-H	BU14P-TR-PC-H	26.0	31.6	32.0	35.6	150
15	BU15P-TR-P-H	BU15P-TR-PC-H	28.0	33.6	34.0	37.6	150
16	BU16P-TR-P-H	BU16P-TR-PC-H	30.0	35.6	36.0	39.6	150

Material and Finish

Post: Copper alloy, copper-undercoated, tin-plated (reflow treatment)
Housing: PA 66, UL94V-0, gray

RoHS compliance This product displays (LF)(SN) on a label.

KR FAMILY SERIES/KRW·KR·PHN·TR CONNECTOR

TRW connector (Unit for wire-to-wire connection)

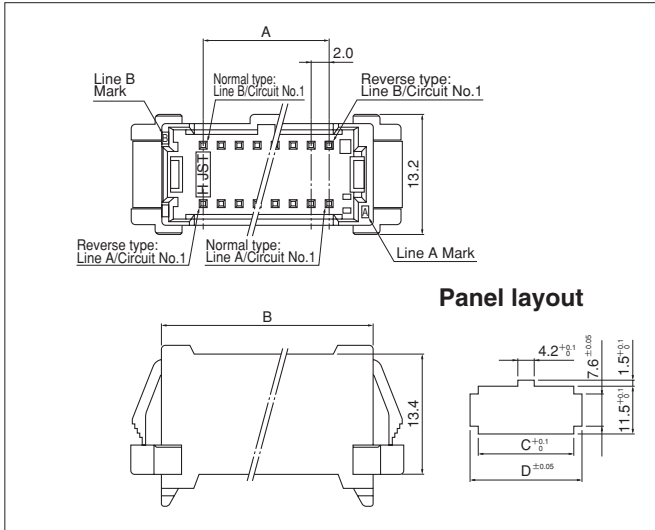

Circuits	Model No.		Dimensions (mm)				Q'ty / box
	Normal type	Reverse type	A	B	C	D	
16	BU16P-TRW-P-H	BU16P-TRW-PC-H	14.0	23.5	23.9	27.5	100
18	BU18P-TRW-P-H	BU18P-TRW-PC-H	16.0	25.5	25.9	29.5	100
20	BU20P-TRW-P-H	BU20P-TRW-PC-H	18.0	27.5	27.9	31.5	50
22	BU22P-TRW-P-H	BU22P-TRW-PC-H	20.0	29.5	29.9	33.5	50
24	BU24P-TRW-P-H	BU24P-TRW-PC-H	22.0	31.5	31.9	35.5	50
26	BU26P-TRW-P-H	BU26P-TRW-PC-H	24.0	33.5	33.9	37.5	50
28	BU28P-TRW-P-H	BU28P-TRW-PC-H	26.0	35.5	35.9	39.5	50
30	BU30P-TRW-P-H	BU30P-TRW-PC-H	28.0	37.5	37.9	41.5	50
32	BU32P-TRW-P-H	BU32P-TRW-PC-H	30.0	39.5	39.9	43.5	50

Material and Finish

Post: Copper alloy, copper-undercoated, tin-plated (reflow treatment)
Housing: PA 66, UL94V-0, gray

RoHS compliance This product displays (LF)(SN) on a label.

<For reference> As the color identification, the following alphabet shall be put in the underlined part. For availability, delivery and minimum order quantity, contact JST.

ex. **BU16P-TRW-P-H**

H...gray Y...yellow R...red N...brown
S...natural (white) M...green