

10 9 8 7 6 5 4 3 2 1

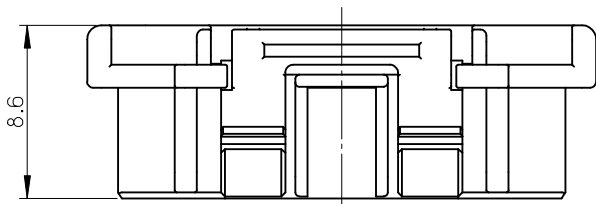

2,3極形状 (1ロック)
FIGURE OF 2.3 CIRCUIT (1 LOCK)

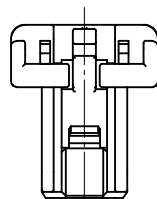

4,5極形状 (1ロック)
FIGURE OF 4.5 CIRCUIT (1 LOCK)

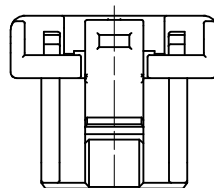

6極形状 (2ロック)
FIGURE OF 6 CIRCUIT (2 LOCK)

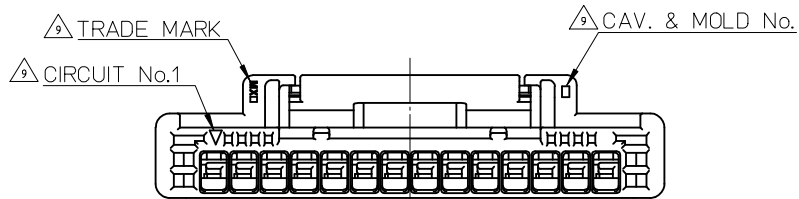
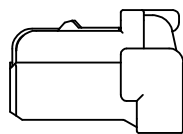
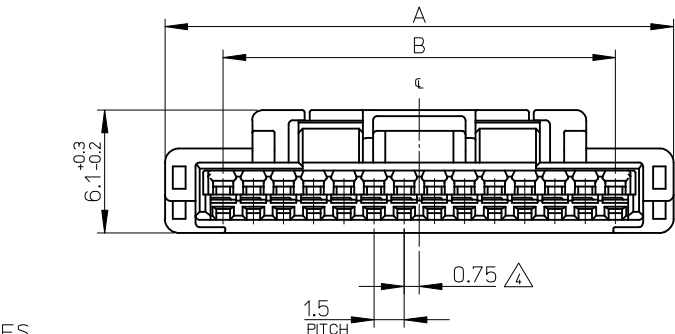
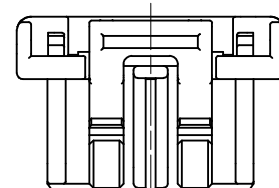

NOTES

1. 材料 MATERIAL
ハウジング : PBT , UL94-V0
HOUSING : PBT , UL94-V0
2. 嵌合相手 : 502584,502585,503159,503175,503339,503340,503395 シリーズ
MATE WITH : 502584,502585,503159,503175,503339,503340,503395 SERIES.
3. 適合ターミナル : 502579, 503429 シリーズ
APPLICABLE TERMINAL : 502579, 503429 SERIES.

△ 極数/2=偶数極の場合に適用
APPLY FOR (CIRCUIT/2)=EVEN

△ 注文番号
ORDER No.

502578 - * * * * *

↑ 極数 ↑ 色
CIRCUIT SIZE COLOR

6. 本製品のプラスチック部に黒点・白点等が確認される場合や色合いが異なる場合がありますが、製品性能に影響はありません。
THERE IS NO INFLUENCE IN THE PRODUCT PERFORMANCE THOUGH THE BLACK AND WHITE SPOT ETC. MIGHT BE CONFIRMED TO THE PLASTIC PART OF THIS PRODUCT AND THE SHADE MIGHT BE DIFFERENT.
7. アプリケーション仕様書(コネクタ取扱説明書) : AS-502578-001, AS-502578-002
APPLICATION SPECIFICATIONS (CONNECTOR MANUAL): AS-502578-001, AS-502578-002
8. 製品仕様書 : PS-502584-001
Product specification: PS-502584-001

△ トレードマーク : MX プラス1文字の製造工場を示すアルファベットにて表示。但し"J"は JAPAN を示す。(例 MXJ)

キャビティ番号 : 1桁から2桁の数字にて表示。
金型番号 : アルファベット1文字にて表示。

FORMED BY MX AND 1 MORE LETTER OF ALPHABET WHICH MEAN THE MANUFACTORY. BUT "J" MEANS JAPAN. (TO TRADE MARK) (e.g. MXJ) AND BY 1 - 2 DIGIT NUMBER (TO CAVITY No.) AND BY 1 LETTER OF ALPHABET (TO MOLD No.)

10. ELV 及び RoHS 適合品
ELV AND RoHS COMPLIANT

No.	COLOR	CIRCUIT	
00	ベージュ BEIGE	2~15	
01	黒 BLACK		
02	赤 RED		
03	黄 YELLOW		
04	青 BLUE		
05	桃 PINK		
06	緑 GREEN		
07	茶 BROWN		
08	橙 ORANGE		
09	紫 VIOLET		
14	水 PALE BLUE		2

21	26.8	502578-15**	15
19.5	25.3	↑ -14**	14
18	23.8	-13**	13
16.5	22.3	-12**	12
15	20.8	-11**	11
13.5	19.3	-10**	10
12	17.8	-09**	9
10.5	16.3	-08**	8
9	14.8	-07**	7
7.5	13.3	-06**	6
6	11.8	-05**	5
4.5	10.3	-04**	4
3	8.8	↓ -03**	3
1.5	7.3	502578-02**	2
B	A	△ PLASTIC BAG △ ORDER No.	CIRCUIT No.

REVISED EC NO.: J2009-2139 DRW:KSETO 2009/03/23 CHKD:KASAKAWA 2009/03/24 APPR: S ICHIKAWA 2009/03/24	GENERAL TOLERANCES (UNLESS SPECIFIED)		DIMENSION STYLE MM ONLY		SCALE 4:1	DESIGN UNITS METRIC		THIRD ANGLE PROJECTION	
	10 UNDER	±0.2	DRAWN BY N. ITO	DATE '07/07/09	TITLE 1.5MM W/B CONN. SINGLE PLUG HOUSING				
	10 OVER 30 UNDER	±0.25	CHECKED BY K. ASAKAWA	DATE '07/07/10	MOLEX INCORPORATED				
	30 OVER	±0.3	APPROVED BY Y. ITO	DATE '07/07/10					
ANGULAR	±3 °	MATERIAL NO. SEE TABLE		DOCUMENT NO. SD-502578-001		SHEET NO. 1 OF 1			
DRAFT WHERE APPLICABLE MUST REMAIN WITHIN DIMENSIONS		THIS DRAWING CONTAINS INFORMATION THAT IS PROPRIETARY TO MOLEX INCORPORATED AND SHOULD NOT BE USED WITHOUT WRITTEN PERMISSION							