

SECTION Z-Z

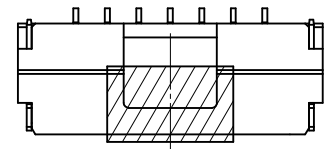

カプトンテープ付き  
WITH KAPTON TAPE

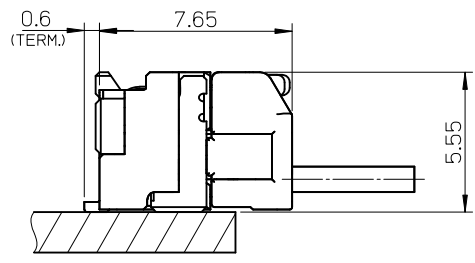
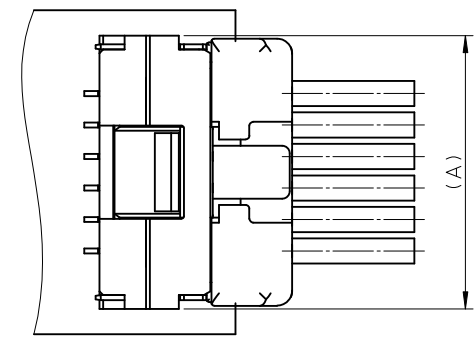
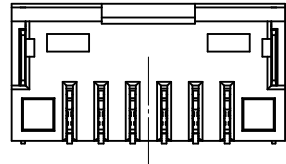
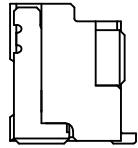

嵌合図  
MATED CONNECTORS

NOTES

1. 嵌合相手: 502380-\*\*\*\*  
MATE WITH : 502380-\*\*\*\*
2. 端子テール部 及び ネイルの平坦度: 0.1MAX.  
TAIL AND NAIL COPLANARITY TO BE 0.1 MAX.
3. 極数/2=偶数に適用.  
APPLY FOR CKT. SIZE / 2 = EVEN.
4. 端子テール部 及び ネイルに錫めっきを使用しているため、  
外観に摺動痕が付く場合が御座います。  
THE WOUND OF FRICTION MIGHT ADHERE TO EXTERNALS  
BECAUSE THE TIN PLATING IS USED FOR THA TAIL AND NAIL.
5. 本製品のプラスチック部に黒点等が確認される場合や  
色合いが異なる場合がありますが、製品性能に影響はありません。  
THERE IS NO INFLUENCE IN THE PRODUCT PERFORMANCE THOUGH  
THE BLACK SPOT ETC. MIGHT BE CONFIRMED TO THE PLASTIC PART  
OF THIS PRODUCT AND THE SHADE MIGHT BE DIFFERENT.
6. ELV 及び RoHS 適合品  
ELV AND RoHS COMPLIANT

3.4	7.5	11	12.1	502386-07**	7
3.4	6.25	9.75	10.85	502386-06**	6
3.4	5	8.5	9.6	502386-05**	5
3.4	3.75	7.25	8.35	502386-04**	4
2.6	2.5	6	7.1	502386-03**	3
2.2	1.25	4.75	5.85	502386-02**	2
D	C	B	A	EMBOSSED TAPE PACKAGE オーダー番号 ORDER No.	極数 (CKT. NO.)

番号 NO.	部品 PART	材質 MATERIAL
①	ハウジング HOUSING	耐熱性樹脂 UL94V-0 色:SHEET 3 参照 HEATPROOF RESIN UL94V-0 COLOR : SEE SHEET 3
②	ターミナル TERMINAL	銅合金 COPPER ALLOY 錫めっき : 1.0 micro-meter MIN. TIN (TAIL AREA) ニッケルめっき(下地): 1.0 micro-meter MIN. NICKEL (UNDER PLATING)
③	ネイル NAIL	銅合金 COPPER ALLOY 錫めっき: 1.0 micro-meter MIN. TIN ニッケルめっき(下地): 1.0 micro-meter MIN. NICKEL (UNDER PLATING)

REVISED EC NO.: J2010-2320 DRWN: YGOTO 2010/05/19 CHKD: K. ASAKAWA 2010/05/20 APPR: NUKITA 2010/05/21	DESCRIPTION GENERAL TOLERANCES (UNLESS SPECIFIED) 10 UNDER ±0.2 10 OVER 30 UNDER ±0.25 30 OVER ±0.3 ANGULAR ±3 ° DRAFT WHERE APPLICABLE MUST REMAIN WITHIN DIMENSIONS	DIMENSION STYLE MM ONLY DRAWN BY DATE T. MIYAZAKI 2006/08/28 CHECKED BY DATE K. ASAKAWA 2006/08/28 APPROVED BY DATE YO. ITO 2006/08/28	SCALE 5:1 DESIGN UNITS METRIC THIRD ANGLE PROJECTION	TITLE 1.25 W/B CONN. SINGLE R/A REC. ASS'Y 2-7CKT.	
				MOLEX INCORPORATED SEE TABLE SD-502386-001	
				MATERIAL NO. DOCUMENT NO. SHEET NO. THIS DRAWING CONTAINS INFORMATION THAT IS PROPRIETARY TO MOLEX INCORPORATED AND SHOULD NOT BE USED WITHOUT WRITTEN PERMISSION	
				SIZE A3	

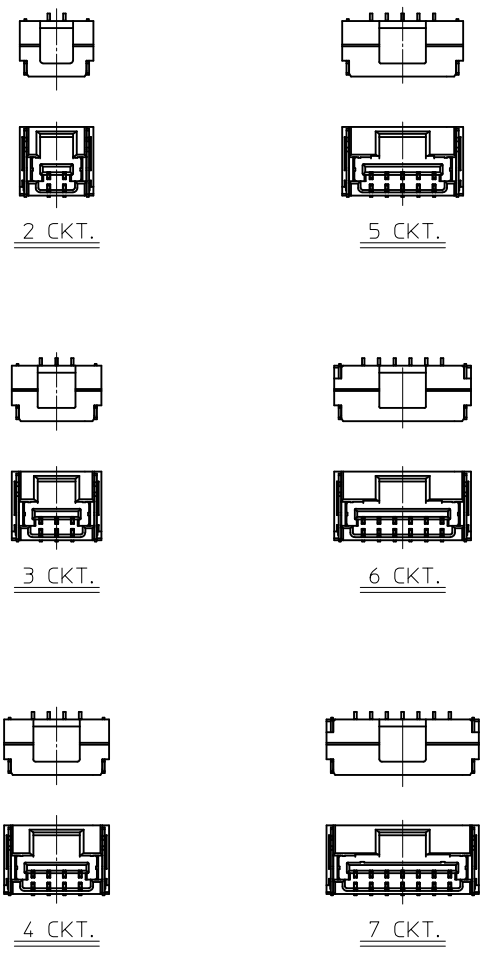

極数の種類  
KIND OF CKT. NO.(FRONT VIEW)

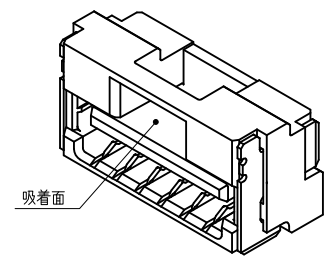
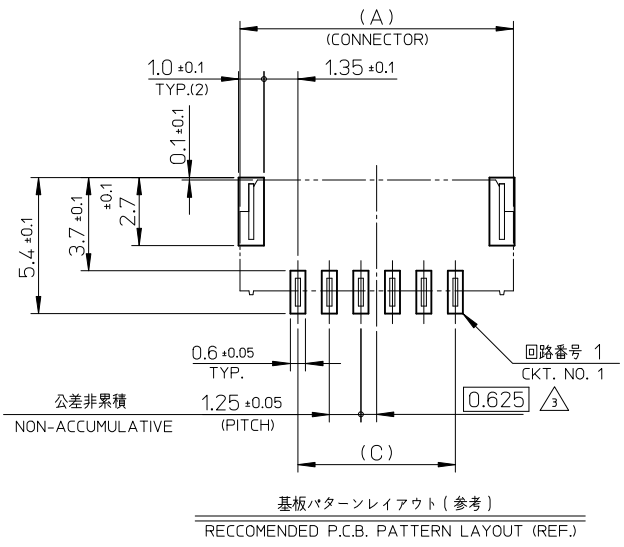
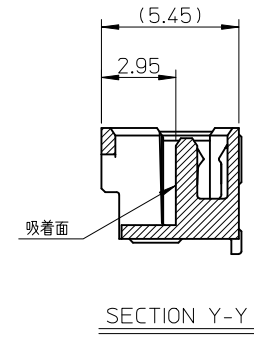
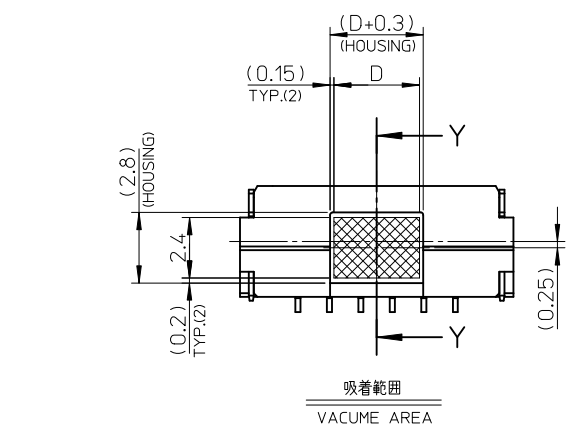

REVISED EC NO.: J2010-2320 DRWN: YG010 2010/05/19 CHK'D: K. ASAKAWA 2010/05/20 APPR: NUKITA 2010/05/21	GENERAL TOLERANCES (UNLESS SPECIFIED)		DIMENSION STYLE MM ONLY	SCALE 5:1	DESIGN UNITS METRIC	THIRD ANGLE PROJECTION
	10 UNDER	±0.2	DRAWN BY T. MIYAZAKI	DATE 2006/08/28	TITLE 1.25 W/B CONN. SINGLE R/A REC. ASS'Y 2-7CKT.	
	10 OVER 30 UNDER	±0.25	CHECKED BY K. ASAKAWA	DATE 2006/08/28	MOLEX INCORPORATED	
	30 OVER	±0.3	APPROVED BY Y.O. ITO	DATE 2006/08/28	MATERIAL NO. SEE TABLE	DOCUMENT NO. SD-502386-001
REV	DESCRIPTION	ANGULAR ±3 °	THIS DRAWING CONTAINS INFORMATION THAT IS PROPRIETARY TO MOLEX INCORPORATED AND SHOULD NOT BE USED WITHOUT WRITTEN PERMISSION			
		DRAFT WHERE APPLICABLE MUST REMAIN WITHIN DIMENSIONS				

WITH CAPTON TAPE										
HSG COLOR : GREEN		HSG COLOR : BLUE		HSG COLOR : RED		HSG COLOR : BLACK		HSG COLOR : NATURAL		
502386-0736	502386-**16	502386-0734	502386-**14	502386-0732	502386-**12	502386-0731	502386-**11	502386-0772	502386-**08	7
502386-0636		502386-0634		502386-0632		502386-0631		502386-0672		6
502386-0536		502386-0534		502386-0532		502386-0531		502386-0572		5
502386-0436		502386-0434		502386-0432		502386-0431		502386-0472		4
502386-0336		502386-0334		502386-0332		502386-0331		502386-0372		3
502386-0236		502386-0234		502386-0232		502386-0231		502386-0272		2
EMBOSSSED TAPE PACKAGE オーダー番号ORDER No.	コネクタ シリズ CONNECTOR SIRIES	EMBOSSSED TAPE PACKAGE オーダー番号ORDER No.	コネクタ シリズ CONNECTOR SIRIES	EMBOSSSED TAPE PACKAGE オーダー番号ORDER No.	コネクタ シリズ CONNECTOR SIRIES	EMBOSSSED TAPE PACKAGE オーダー番号ORDER No.	コネクタ シリズ CONNECTOR SIRIES	EMBOSSSED TAPE PACKAGE オーダー番号ORDER No.	コネクタ シリズ CONNECTOR SIRIES	極数 (KT. NO.)

WITHOUT CAPTON TAPE										
HSG COLOR : GREEN		HSG COLOR : BLUE		HSG COLOR : RED		HSG COLOR : BLACK		HSG COLOR : NATURAL		
502386-0746	502386-**26	502386-0744	502386-**24	502386-0742	502386-**22	502386-0741	502386-**21	502386-0770	502386-**09	7
502386-0646		502386-0644		502386-0642		502386-0641		502386-0670		6
502386-0546		502386-0544		502386-0542		502386-0541		502386-0570		5
502386-0446		502386-0444		502386-0442		502386-0441		502386-0470		4
502386-0346		502386-0344		502386-0342		502386-0341		502386-0370		3
502386-0246		502386-0244		502386-0242		502386-0241		502386-0270		2
EMBOSSSED TAPE PACKAGE オーダー番号ORDER No.	コネクタ シリズ CONNECTOR SIRIES	EMBOSSSED TAPE PACKAGE オーダー番号ORDER No.	コネクタ シリズ CONNECTOR SIRIES	EMBOSSSED TAPE PACKAGE オーダー番号ORDER No.	コネクタ シリズ CONNECTOR SIRIES	EMBOSSSED TAPE PACKAGE オーダー番号ORDER No.	コネクタ シリズ CONNECTOR SIRIES	EMBOSSSED TAPE PACKAGE オーダー番号ORDER No.	コネクタ シリズ CONNECTOR SIRIES	極数 (KT. NO.)

REVISED EC NO: J2010-2320 DRWN: YGOTO 2010/05/19 CH'KD: K. ASAKAWA 2010/05/20 APPR: NUKITA 2010/05/21	GENERAL TOLERANCES (UNLESS SPECIFIED)		DIMENSION STYLE <b>MM ONLY</b>		SCALE ----	DESIGN UNITS <b>METRIC</b>	THIRD ANGLE PROJECTION	
	10 UNDER	±0.2	DRAWN BY DATE T. MIYAZAKI 2006/08/28		TITLE 1.25 W/B CONN. SINGLE R/A REC. ASS'Y 2-7CKT.			
	10 OVER 30 UNDER	±0.25	CHECKED BY DATE K. ASAKAWA 2006/08/28		APPROVED BY DATE YO. ITO 2006/08/28			
	30 OVER	±0.3	MATERIAL NO. <b>SEE TABLE</b>		DOCUMENT NO. <b>SD-502386-001</b>		SHEET NO. 3 OF 3	
	ANGULAR ±3 °		SIZE <b>A3</b>		THIS DRAWING CONTAINS INFORMATION THAT IS PROPRIETARY TO MOLEX INCORPORATED AND SHOULD NOT BE USED WITHOUT WRITTEN PERMISSION			
	DRAFT WHERE APPLICABLE MUST REMAIN WITHIN DIMENSIONS							

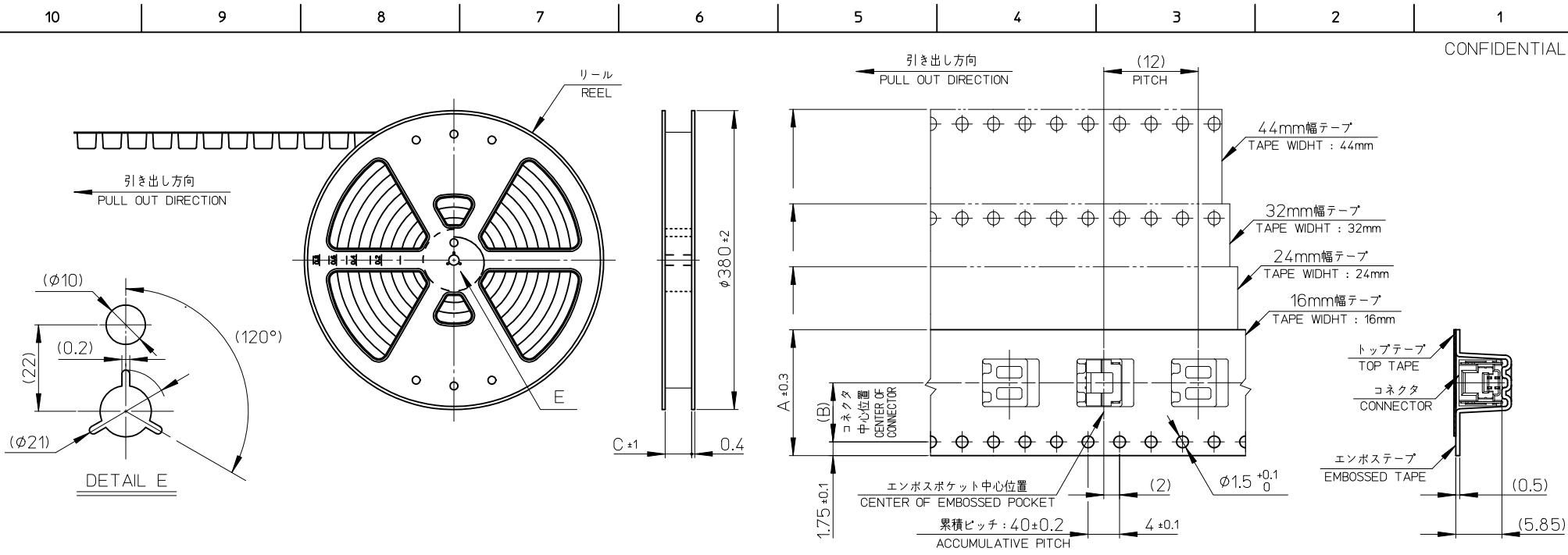

NOTES

- 製品詳細寸法については、SD-502386-001, -002 を参照下さい。  
PLEASE REFER TO SD-502386-001, -002 FOR THE DETAILED DIMENSION OF THE CONNECTOR.
- 梱包数量 : 1200個  
NUMBER OF CONNECTIONS : 1200 PIECES/REEL.
- リードテープ長さ  
LEAD TAPE LENGTH

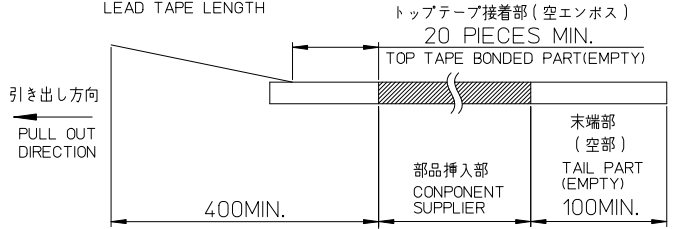

- 材料  
MATERIAL  
キャリアテープ : ポリスチレン  
CARRIER TAPE : POLYSTYRENE  
トップテープ : ポリエステル, ポリエチレン, ポリエチレンテレフタレート  
TOP TAPE : POLYESTER, POLYETHYLENE, POLYETHYLENE TEREPHTHALATE  
リール : ポリスチレン <リサイクル材を含む>  
REEL : POLYSTYRENE <RECYCLE MATERIAL CONTAINED>
- ELV 及び RoHS 適合品  
ELV AND ROHS COMPLIANT

45.5	20.2	44	502386-15**	15
45.5	20.2	44	502386-14**	14
33.5	14.2	32	502386-13**	13
33.5	14.2	32	502386-12**	12
33.5	14.2	32	502386-11**	11
33.5	14.2	32	502386-10**	10
25.5	11.5	24	502386-09**	9
25.5	11.5	24	502386-08**	8
25.5	11.5	24	502386-07**	7
25.5	11.5	24	502386-06**	6
25.5	11.5	24	502386-05**	5
25.5	11.5	24	502386-04**	4
17.5	7.5	16	502386-03**	3
17.5	7.5	16	502386-02**	2
C	B	エンボステープ幅 A WIDTH OF TAPE	製品番号 MATERIAL NO.	極数 EXT. NO.

REVISED EC NO: J2011-0737 DRWN:TKGN 2010/11/29 CHKD: APPR:NUKITA 2010/11/29	GENERAL TOLERANCES (UNLESS SPECIFIED)		DIMENSION STYLE MM ONLY	SCALE ---	DESIGN UNITS METRIC	THIRD ANGLE PROJECTION
	10 UNDER	± 0.2	DRAWN BY T. MIYAZAKI	DATE 2006/10/16	TITLE 1.25 W/B CONN. SINGLE R/A REC. EMBTP PKG	
	10 OVER 30 UNDER	± 0.25	CHECKED BY K. ASAKAWA	DATE 2006/10/16	MOLEX INCORPORATED	
	30 OVER	± 0.3	APPROVED BY YO. ITO	DATE 2006/10/16	DOCUMENT NO. SD-502386-003	SHEET NO. 1 OF 2
	ANGULAR ± 3 °	DRAFT WHERE APPLICABLE MUST REMAIN WITHIN DIMENSIONS	MATERIAL NO. SEE TABLE	THIS DRAWING CONTAINS INFORMATION THAT IS PROPRIETARY TO MOLEX INCORPORATED AND SHOULD NOT BE USED WITHOUT WRITTEN PERMISSION		

WITHOUT CAPTON TAPE			WITH CAPTON TAPE										
HSG COLOR : ORANGE			HSG COLOR : GREEN		HSG COLOR : BLUE		HSG COLOR : RED		HSG COLOR : BLACK		HSG COLOR : NATURAL		
502386-**28	--//	15	--//	--//	--//	--//	--//	--//	--//	--//	--//	--//	15
	--//	14	--//	--//	--//	--//	--//	--//	--//	--//	--//	--//	14
	--//	13	--//	--//	--//	--//	--//	--//	--//	--//	--//	--//	13
	--//	12	--//	--//	--//	--//	--//	--//	--//	--//	--//	--//	12
	--//	11	--//	--//	--//	--//	--//	--//	--//	--//	--//	--//	11
	--//	10	--//	--//	--//	--//	--//	--//	--//	--//	--//	--//	10
	502386-0948	9	--//	--//	--//	--//	--//	--//	--//	--//	--//	--//	9
	--//	8	--//	--//	--//	--//	--//	--//	--//	--//	--//	--//	8
	--//	7	--//	--//	--//	--//	--//	--//	--//	--//	--//	--//	7
	--//	6	502386-0736	502386-0636	502386-0734	502386-0634	502386-0732	502386-0632	502386-0731	502386-0631	502386-0730	502386-0630	7
	--//	5	502386-0536	502386-0436	502386-0534	502386-0434	502386-0532	502386-0432	502386-0531	502386-0431	502386-0530	502386-0430	6
	--//	4	502386-0436	502386-0336	502386-0434	502386-0334	502386-0432	502386-0332	502386-0431	502386-0331	502386-0430	502386-0330	5
	--//	3	502386-0336	502386-0236	502386-0334	502386-0234	502386-0332	502386-0232	502386-0331	502386-0231	502386-0330	502386-0230	4
	--//	2	502386-0236		502386-0234		502386-0232		502386-0231		502386-0230		3
	コネクタ シリーズ	製品番号	極数	コネクタ シリーズ	製品番号	コネクタ シリーズ	製品番号	コネクタ シリーズ	製品番号	コネクタ シリーズ	製品番号	コネクタ シリーズ	製品番号
CONNECTOR SERIES	MATERIAL NO.	(KT. NO.)	CONNECTOR SERIES	MATERIAL NO.	CONNECTOR SERIES	MATERIAL NO.	CONNECTOR SERIES	MATERIAL NO.	CONNECTOR SERIES	MATERIAL NO.	CONNECTOR SERIES	MATERIAL NO.	(KT. NO.)

WITHOUT CAPTON TAPE												
HSG COLOR : GREEN			HSG COLOR : BLUE		HSG COLOR : YELLOW		HSG COLOR : RED		HSG COLOR : BLACK		HSG COLOR : NATURAL	
502386-**26	502386-1546	502386-1544	--//	502386-1542	502386-1541	502386-1570	15					
	502386-1446	502386-1444	--//	502386-1442	502386-1441	502386-1470	14					
	502386-1346	502386-1344	--//	502386-1342	502386-1341	502386-1370	13					
	502386-1246	502386-1244	--//	502386-1242	502386-1241	502386-1270	12					
	502386-1146	502386-1144	--//	502386-1142	502386-1141	502386-1170	11					
	502386-1046	502386-1044	--//	502386-1042	502386-1041	502386-1070	10					
	502386-0946	502386-0944	502386-0943	502386-0942	502386-0941	502386-0970	9					
	502386-0846	502386-0844	--//	502386-0842	502386-0841	502386-0870	8					
	502386-0746	502386-0744	--//	502386-0742	502386-0741	502386-0770	7					
	502386-0646	502386-0644	--//	502386-0642	502386-0641	502386-0670	6					
	502386-0546	502386-0544	--//	502386-0542	502386-0541	502386-0570	5					
	502386-0446	502386-0444	--//	502386-0442	502386-0441	502386-0470	4					
	502386-0346	502386-0344	--//	502386-0342	502386-0341	502386-0370	3					
	502386-0246	502386-0244	--//	502386-0242	502386-0241	502386-0270	2					
	コネクタ シリーズ	製品番号	コネクタ シリーズ	製品番号	コネクタ シリーズ	製品番号	コネクタ シリーズ	製品番号	コネクタ シリーズ	製品番号	極数	
CONNECTOR SERIES	MATERIAL NO.	CONNECTOR SERIES	MATERIAL NO.	CONNECTOR SERIES	MATERIAL NO.	CONNECTOR SERIES	MATERIAL NO.	CONNECTOR SERIES	MATERIAL NO.	(KT. NO.)		

REVISED EC NO: J2011-0737 DRWN:TKON 2010/11/29 CHKD: APPR:NIUKITA 2010/11/29	GENERAL TOLERANCES (UNLESS SPECIFIED)		DIMENSION STYLE <b>MM ONLY</b>	SCALE ---	DESIGN UNITS <b>METRIC</b>	THIRD ANGLE PROJECTION	
	10 UNDER ±0.2	10 OVER 30 UNDER ±0.25	DRAWN BY T. MIYAZAKI	DATE 2006/10/16	TITLE 1.25 W/B CONN. SINGLE R/A REC. EMBTP PKG		
	30 OVER ±0.3	ANGULAR ±3 °	CHECKED BY K. ASAKAWA	DATE 2006/10/16	APPROVED BY YO. ITO 2006/10/16		
	DRAFT WHERE APPLICABLE MUST REMAIN WITHIN DIMENSIONS		MATERIAL NO.	DOCUMENT NO.		SHEET NO.	
	SIZE <b>A3</b>		THIS DRAWING CONTAINS INFORMATION THAT IS PROPRIETARY TO MOLEX INCORPORATED AND SHOULD NOT BE USED WITHOUT WRITTEN PERMISSION		MOLEX <b>MOLEX INCORPORATED</b>		SD-502386-003 2 OF 2