

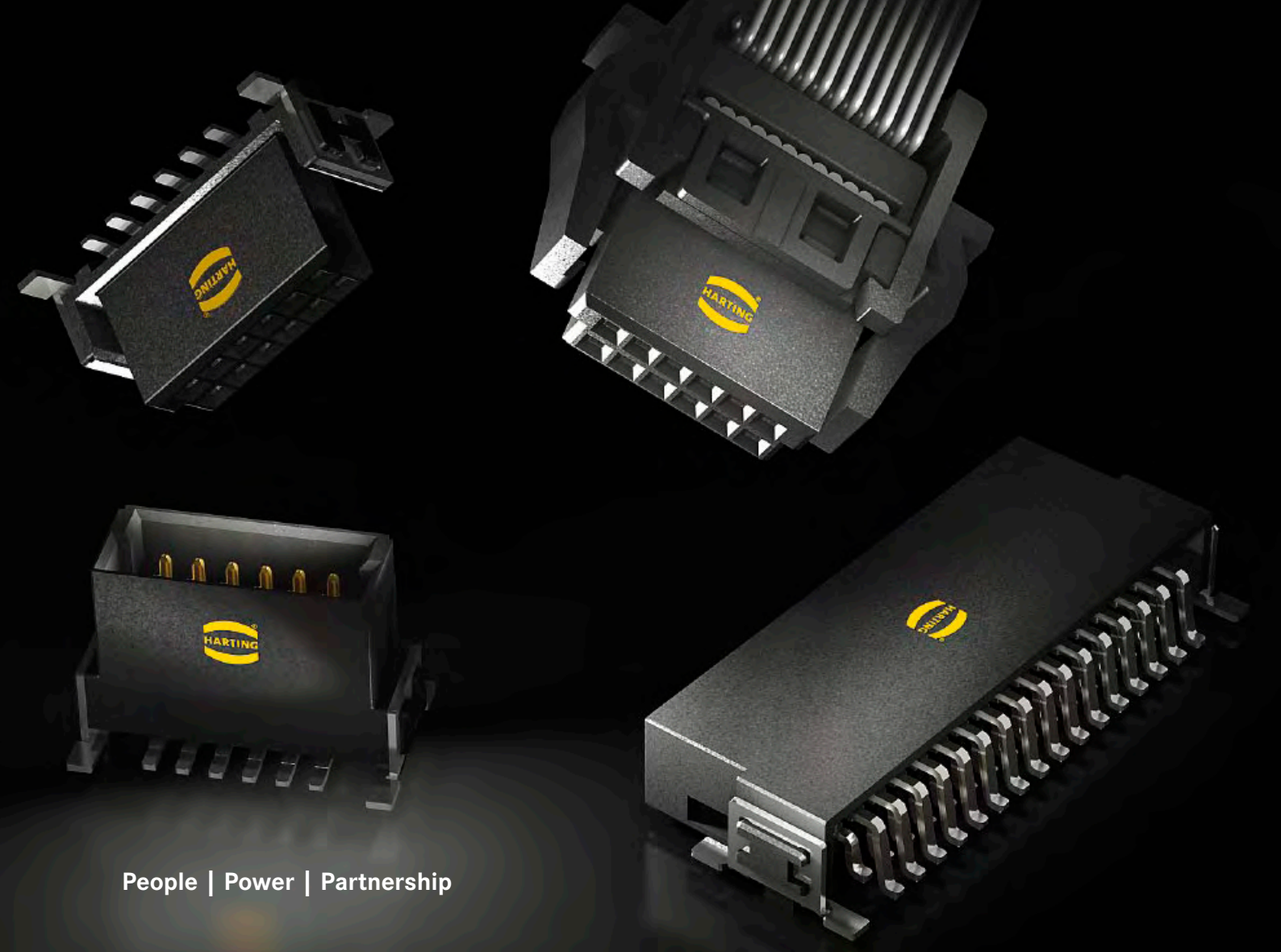

Pushing Performance

# HARTING *har-flex*® connectors



## Transforming customer wishes into concrete solutions



The HARTING Technology Group is skilled in the fields of electrical, electronic and optical connection, transmission and networking, as well as in manufacturing, mechatronics and software creation. The Group uses these skills to develop customized solutions and products such as connectors for energy and data transmission applications including, for example, mechanical engineering, rail technology, wind energy plants, factory automation and the telecommunications sector. In addition, HARTING also produces electro-magnetic components for the automobile industry and offers solutions in the field of Enclosures and Shop Systems. The HARTING Group currently comprises 36 subsidiary companies and worldwide distributors employing a total of approx. 3,400 staff.

**We aspire to top performance.**

Connectors ensure functionality. As core elements of electrical and optical wiring, connection and infrastructure technologies, they are essential in enabling the modular construction of devices, machines and systems across a very wide range of industrial applications. Their reliability is a crucial factor guaranteeing smooth functioning in the manufacturing area, in telecommunications, applications in medical technology – in fact, connectors are at work in virtually every conceivable application area. Thanks to the consistent further development of our technologies, customers enjoy investment security and benefit from durable, long term functionality.

**Always at hand, wherever our customers may be.**

Increasing industrialization is creating growing markets characterized by widely diverging demands and requirements. The search for perfection, increasingly efficient processes and reliable technologies is a common factor in all sectors across the globe.

**HARTING** is providing these technologies – in Europe, America and Asia. The **HARTING** professionals at our international subsidiaries engage in close, partnership based interaction with our customers, right from the very early product development phases, in order to realize customer demands and requirements in the best possible manner.

Our people on location form the interface to the centrally coordinated development and production departments. In this way, our customers can rely on consistently high, superior product quality – worldwide.

**Our claim: Pushing Performance.**

**HARTING** provides more than optimally attuned components. In order to serve our customers with the best possible solutions, **HARTING** is able to contribute a great deal more and play a closely integrative role in the value creation process.

From ready assembled cables through to control racks or ready-to-go control desks: Our aim is to generate the maximum benefits for our customers – without compromise!

**Quality creates reliability – and warrants trust.**

The **HARTING** brand stands for superior quality and reliability – worldwide. The standards we set are the result of consistent, stringent quality management that is subject to regular certifications and audits.

EN ISO 9001, the EU Eco-Audit and ISO 14001:2004 are key elements here. We take a proactive stance to new requirements, which is why **HARTING** ranks among the first companies worldwide to have obtained the new IRIS quality certificate for rail vehicles.



**HARTING technology creates added value for customers.** Technologies by HARTING are at work worldwide. HARTING's presence stands for smoothly functioning systems, powered by intelligent connectors, smart infrastructure solutions and mature network systems. In the course of many years of close, trust-based cooperation with its customers, the HARTING Technology Group has advanced to one of the worldwide leading specialists for connector technology. Extending beyond the basic functionalities demanded, we offer individual customers specific and innovative solutions. These tailored solutions deliver sustained effects, provide investment security and enable customers to achieve strong added value.

**Opting for HARTING opens up an innovative, complex world of concepts and ideas.**

In order to develop connectivity and network solutions serving an exceptionally wide range of connector applications and task scopes in a professional and cost optimized manner, HARTING not only commands the full array of conventional tools and basic technologies. Over and beyond these capabilities, HARTING is constantly harnessing and refining its broad base of knowledge and experience to create new solutions that ensure continuity at the same time. In securing this know-how lead, HARTING draws on a wealth of sources from both in-house research and the world of applications alike.

Salient examples of these sources of innovative knowledge include microstructure technologies, 3D design and construction technology, as well as high temperature

or ultrahigh frequency applications that are finding use in telecommunications or automation networks, in the automotive industry, or in industrial sensor and actuator applications, RFID and wireless technologies, in addition to packaging and housing made of plastics, aluminum or stainless steel.

**HARTING solutions extend across technology boundaries.**

Drawing on the comprehensive resources of the group's technology pool, HARTING devises practical solutions for its customers. Whether this involves industrial networks for manufacturing automation, or hybrid interface solutions for wireless telecommunication infrastructures, 3D circuit carriers with microstructures, or cable assemblies for high-temperature applications in the automotive industry – HARTING technologies offer far more than components, and represent mature, comprehensive solutions attuned to individual customer requirements and wishes. The range covers ready-to-use cable configurations, completely assembled backplanes and board system carriers, as well as fully wired and tested control panels.

In order to ensure the future proof design of RF- and EMC-compatible interface solutions, the central HARTING laboratory (certified to EN 45001) provides simulation tools, as well as experimental, testing and diagnostics facilities all the way through to scanning electron microscopes. In the selection of materials and processes, lifecycle and environmental aspects play a key role, in addition to product and process capability considerations.



**HARTING knowledge is practical know-how generating synergy effects.**

**HARTING** commands decades of experience with regard to the applications conditions of connectors in telecommunications, computer and network technologies and medical technologies, as well as industrial automation technologies, such as the mechanical engineering and plant engineering areas, in addition to the power generation industry or the transportation sector. **HARTING** is highly conversant with the specific application areas in all of these technology fields.

The key focus is on applications in every solution approach. In this context, uncompromising, superior quality is our hallmark. Every new solution found will invariably flow back into the **HARTING** technology pool, thereby enriching our resources. And every new solution we go on to create will draw on this wealth of resources in order to optimize each and every individual solution. In this way, **HARTING** is synergy in action.

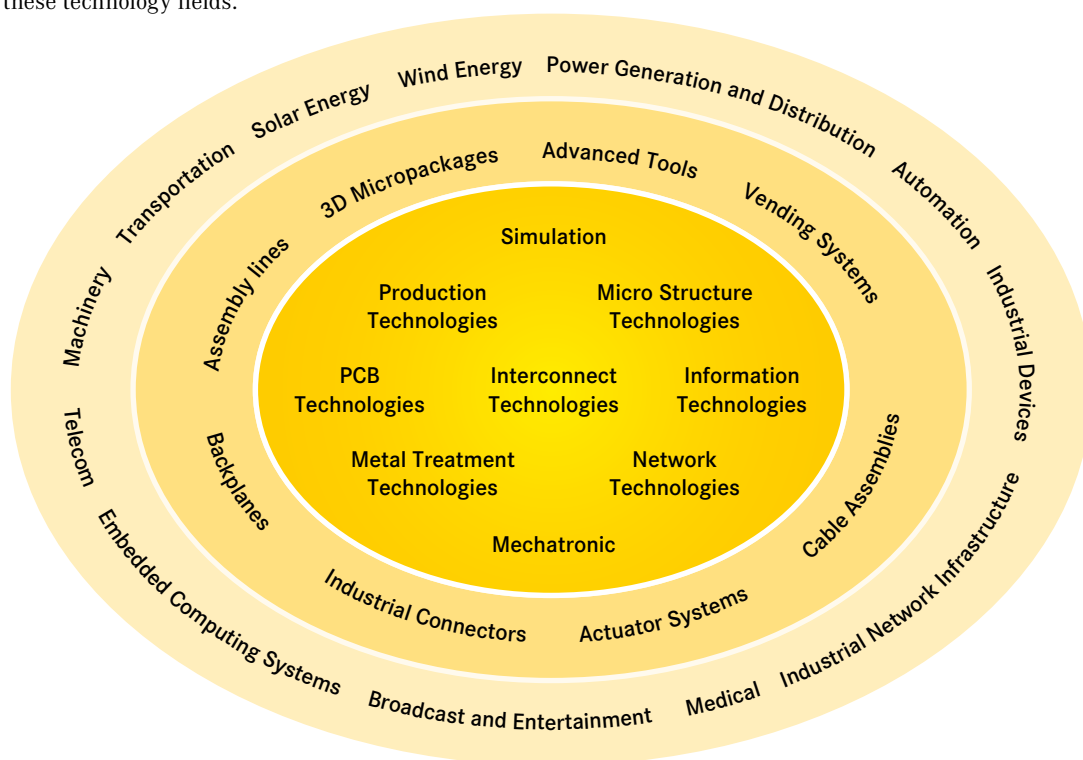

The **HARTING eCatalogue** is an electronic catalogue with a part configuration and 3D components library.

Here you can choose a connector according to your requirements. Afterwards you are able to send your inquiry directly to a HARTING sales partner.

The drawings to every single part are available in PDF-format.

The parts are downloadable in 2D-format (DXF) and 3D-format (IGES, STEP).

The 3D-models can be viewed with a VRML-viewer.

You can find the **HARTING eCatalogue** at [www.HARTING.com](http://www.HARTING.com).

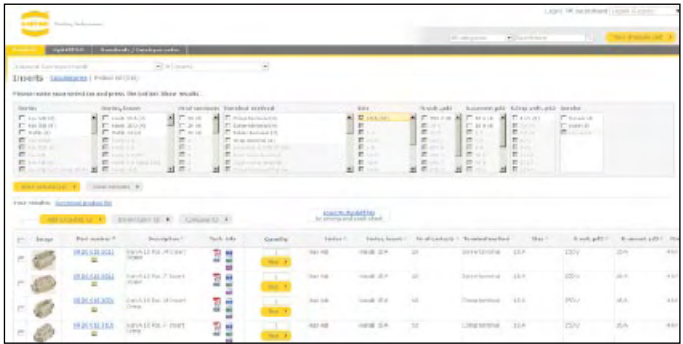

Product selection



Product configuration

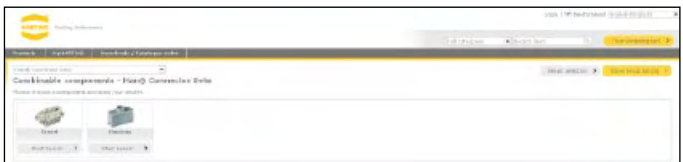

Product combination



Product overview

## Product samples: Fast-track delivery to your desk, free of charge

The new free express sample service in the HARTING eCatalogue allows customers to order samples immediately, easily and completely free of charge. A broad selection from the device connectivity product portfolio is now available. If a product is unavailable, the system offers alternative products with similar features that can be requested at a mouse click.

The free samples are shipped within 48 hours at no cost to you. This service enables tremendous flexibility, especially in the design phase of projects.

### General information

It is the customer's responsibility to check whether the components illustrated in this catalogue also comply with different regulations from those stated in special fields of applications.

We reserve the right to modify designs or substance of content in order to improve quality, keep pace with technological advancement or meet particular requirements in production.

No part of this catalogue may be reproduced in any form (print, photocopy, microfilm or any other process) or processed, duplicated or distributed by means of electronic systems without the prior written consent of HARTING Electronics GmbH & Co. KG, Espelkamp. We are bound by the German version only.

**harflex® connectors**

Page

<i>harflex</i> ® connector system – introduction .....		<b>8</b>
Technical characteristics .....		<b>10</b>
Male connectors, straight .....		<b>14</b>
Female connectors, straight .....		<b>16</b>
Male connectors, angled .....		<b>18</b>
Female connectors, angled .....		<b>20</b>
Female connectors, IDC .....		<b>22</b>
Strain reliefs for female connectors with IDC termination .....		<b>24</b>
Cable assemblies .....		<b>26</b>
Company addresses .....		<b>28</b>

**har:flex® CONNECTORS**

With *har:flex*®, HARTING has developed a general-purpose PCB connector series for internal and external Device Connectivity. The continuous scalability by an even number of contacts, i.e. from 6 to 100, of the HARTING's *har:flex*® mezzanine connector series is a special feature forming an ideal basis for customized applications. The advantage is clearly evident considering that the connector is always optimized to suit specific applications on the device PCB, while also covering the medium- and small-scale volume range that is typical for the production of industrial devices.

This flexibility is new – HARTING turns an individual design into a standard component. No special tooling changes are needed for

customer-specific solutions, thus HARTING can realize a short delivery time.

**PRODUCT DIVERSITY**

The *har:flex*® product range with SMT termination technology is based on a 1.27 mm grid. With its diverse variants, HARTING provides connectivity solutions for many different board-to-board and cable-to-board applications. For example, two straight connectors are used for the mezzanine application, two angled connectors for PCBs on one level, and a combination allows the well-known pairing of mother and daughter cards. By using the IDC cable connector, two PCBs with large space between can be connected with a flat ribbon cable.

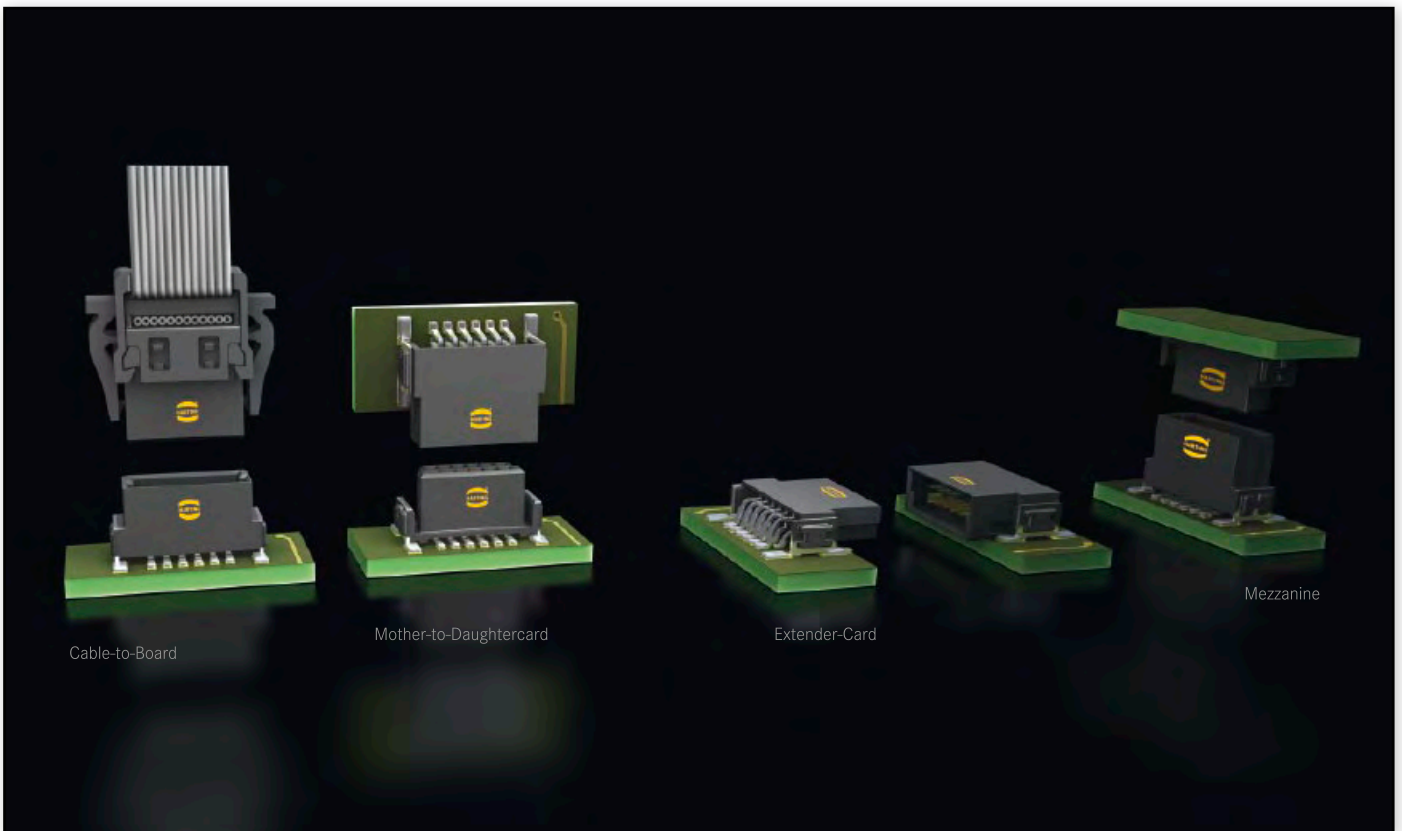



**Many pin count options**

HARTING has developed a modular tooling concept which offers a broad choice of configurations between 6 and 100 poles in even numbered positions. This flexibility in the choice of number of contacts, combined with high density contact spacing, allow the designer to maximize the use of PCB real estate, thereby achieving overall space savings and cost efficiencies.

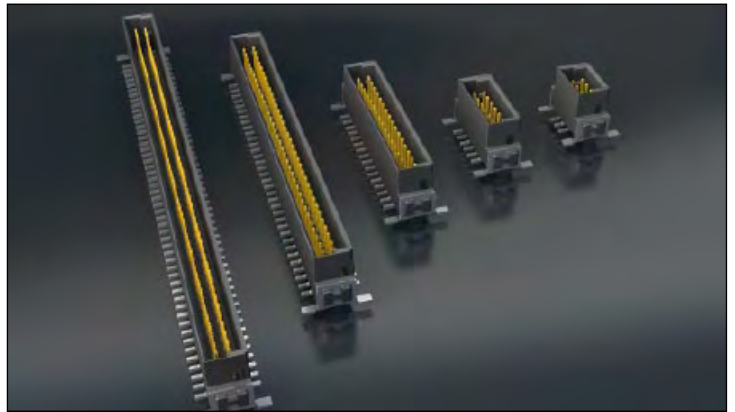

**Flexible board-to-board distances**

HARTING covers mezzanine applications with a range of straight versions for four different stacking heights that can be used to interconnect PCBs arranged in parallel stacks with spacing between 8.0 mm and 13.8 mm. Additional stacking heights are in development. For applications requiring larger spacing between boards HARTING offers compatible cable-to-board connectors with insulation displacement technology.

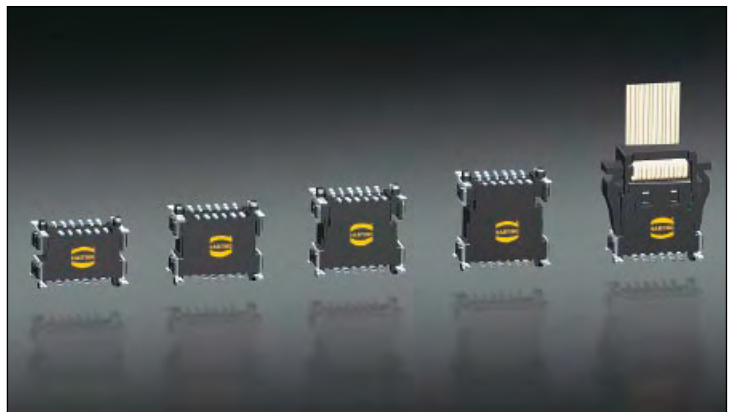

**Robust design**

The special SMT fixing ensures a robust and enduring connection to the PCB and helps to absorb mechanical stress on the solder contacts resulting from insertion and removal forces.

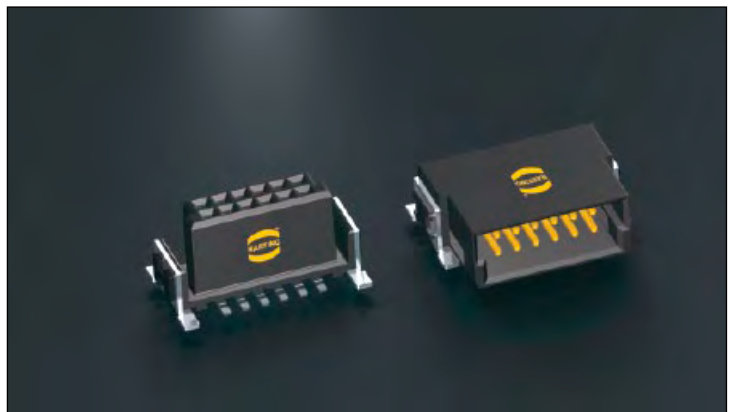

**Automated processing features**

The har-flex® SMT connectors meet the highest demands in terms of their processing capabilities. Special blister packaging provides protection during shipping and handling, while the “pick and place” pads enable automated assembly of the PCBs. The temperature resistant materials of the insulating body, in combination with consistent testing of the coplanarity of contacts, ensure reliable soldering capabilities of the connectors in the reflow process.



Number of contacts	6, 8, 10 ... 96, 98, 100
Connector pitch	1.27 mm x 1.27 mm [0.050" x 0.050"]
Clearance and creepage distance	
Board connectors (SMT)	min. 0.4 mm
Cable connectors (IDC)	
AWG 30/1 (solid)	min. 0.35 mm
AWG 30/7 (stranded)	min. 0.4 mm
Test voltage $U_{r.m.s.}$	500 V
Contact resistance	< 25 mΩ
Insulation resistance	> 10 GΩ
Insertion and withdrawal force	approx. 0.5 N / contact
Working temperature range	- 55 °C ... + 125 °C
The higher temperature limit includes the local ambient and heating effects of the contacts under load	
Temperature during reflow soldering (acc. to ECA/IPC/JEDEC J-STD-075 Level PSL R0)	min. 150 s > 217 °C min. 30 s > 240 °C
Electrical termination	
Board connectors	SMT (Surface Mount Technology)
Cable connectors	IDC (Insulation Displacement Connection)
Materials	
Moulding material	LCP
UL approval	UL 94-V0
CTI value (Comparative Tracking Index)	175
Contacts base material	Copper alloy
Contact surface	
Mating side	
Board connectors	Au over PdNi (acc. performance level)
Cable connectors	Au over PdNi (acc. performance level)
Termination side	
Board connectors (SMT)	Sn
Cable connectors (IDC)	Sn
Flat cable requirements for IDC connectors	
PVC flat cables:	AWG 30/1 (solid) AWG 30/7 (stranded)
PTFE flat cables:	AWG 30/1 (solid)
Insulation diameter:	min. 0.55 mm - max. 0.75 mm
Working current acc. to IEC 60512	
70 °C ambient temperature @ 80 % derating	
6 pins	1.2 A
32 pins	0.8 A
68 pins	0.75 A
100 pins	0.7 A

### Current carrying capacity

The current carrying capacity is limited by maximum temperature of materials for inserts and contacts including terminals.

The current capacity-curve is valid for continuous, not interrupted current-loaded contacts of connectors when simultaneous power on all contacts is given, without exceeding the maximum temperature.

Control and test procedures according to DIN IEC 60512.

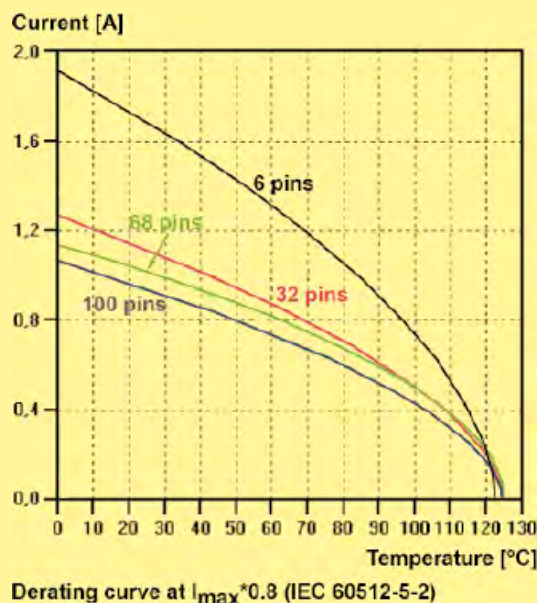

### Durability

#### Performance level 1 (recommended for majority of applications)

Initial 250 mating cycles, 10 days gas test (25 °C/75 % r.h.) using H<sub>2</sub>S 10 ppb, NO<sub>2</sub> 200 ppb, CL<sub>2</sub> 10 ppb, SO<sub>2</sub> 200 ppb. Measurement of contact resistance. The remaining 250 mating cycles are subject to measurement of contact resistance and visual inspection. Visual inspection. No abrasion of the contact finish through to the base material. No functional impairment.

Part number definition: 15 .. ... 2... ...

#### Performance level 2

Initial 125 mating cycles, 4 days gas test (25 °C/75% r.h.) using H<sub>2</sub>S 10 ppb, NO<sub>2</sub> 200 ppb, CL<sub>2</sub> 10 ppb, SO<sub>2</sub> 200 ppb. Measurement of contact resistance. The remaining 125 mating cycles are subject to measurement of contact resistance and visual inspection. Visual inspection. No abrasion of the contact finish through to the base material. No functional impairment.

Part number definition: 15 .. ... 6... ...

#### Performance level S4

Defined contact surface of min. 0.06 μm Au over 0.7+0.2 μm PdNi.

Part number definition: 15 .. ... 5... ...

### Working voltage acc. to IEC 60664-1

The working voltage depends on user specific operational conditions. Depending on the installation category, the degree of pollution and the entire electrical environment, the working voltage is different. The standard IEC 60664-1 specifies, in general, the minimum insulation distances for equipment. But it can also be used to determine the maximum working voltage with given requirements.

The following table shows the most common conditions applicable for the har-flex® connectors and exemplary calculations for the working voltage. For installation category, degree of pollution and other requirements which are not shown in the table we refer to the IEC 60664-1.

Clearance / Creepage distance	0.4 mm			
CTI-Value	< 400			
Isolation group	III a/b			
Electrical field type	Case A (Inhomogeneous field)		Case B (Homogeneous field)	
Installation category	I	II	I	II
Degree of pollution	1	1	1	1
<b>Working voltage max.</b>	<b>150 V</b>	<b>100 V</b>	<b>150 V</b>	<b>150 V</b>

### Explanations:

- CTI value and isolation group are fixed values by the har-flex® connector characteristics.
- Installation category I: Equipment is intended for use only in appliances or installation parts, in which no overvoltages can occur. Equipment in this installation category is normally operated at extra low voltage.
- Installation category II: Equipment is intended for use in installations or parts of installations, in which lightning overvoltages need not be considered. Overvoltages caused by switching must be taken into account.
- Pollution degree 1: No pollution or only dry, non-conductive pollution occurs. The pollution has no influence.
- Pollution degree 2: Only non-conductive pollution occurs. A temporary conductive caused by condensation must be expected occasionally.

### Part number definition

The har-flex® part numbers have 14 digits and are based on the following scheme:



15 har-flex® family

#### Connector style

- 11 straight male connector  
1.75 mm stacking height
- 12 straight male connector  
3.25 mm stacking height
- 15 angled male connector
- 21 straight female connector  
6.25 mm stacking height
- 22 straight female connector  
9.05 mm stacking height
- 25 angled female connector
- 29 IDC flat band cable  
connector / accessories

#### Number of contacts

#### Durability

- 2 performance level 1
- 5 performance level S4
- 6 performance level 2

#### Termination

- 5 IDC termination
- 6 SMT termination

#### Counting number

#### Packaging

- 000 Tape and reel packaging  
Tray packaging for  
IDC cable connectors
- 333 Samples

### Stacking heights of straight connector versions

The harflex® connectors cover mezzanine applications with a range of straight versions for four different stacking heights that can be used to interconnect PCBs arranged in parallel stacks with spacing between 8.0 mm and 13.8 mm.

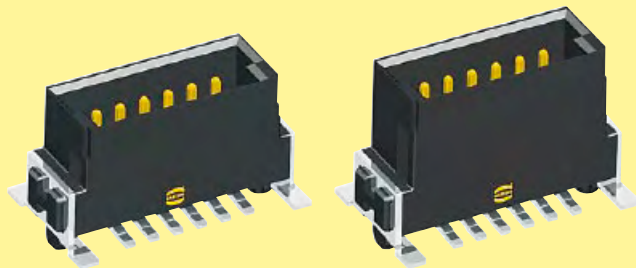

Male 1.75 mm

Male 3.25 mm

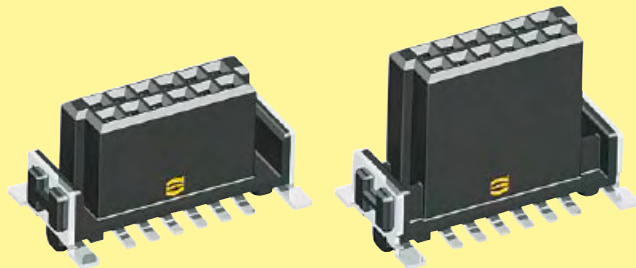

Female 6.25 mm

Female 9.05 mm

Due to the wiping lengths of 1.5 mm, these four connectors cover the distance of 8 mm to 13.8 mm continuously.

14 mm				
13 mm				
12 mm				
11 mm				
10 mm				
9 mm				
8 mm				
stacking heights	male 1.75 mm female 6.25 mm	male 3.25 mm female 6.25 mm	male 1.75 mm female 9.05 mm	male 3.25 mm female 9.05 mm
PCB distance	8 mm - 9.5 mm	9.5 mm - 11 mm	10.8 mm - 12.3 mm	12.3 mm - 13.8 mm
part numbers	15 11 ... 15 21 ...	15 12 ... 15 21 ...	15 11 ... 15 22 ...	15 12 ... 15 22 ...

### Mating options

#### Mezzanine connection

straight female

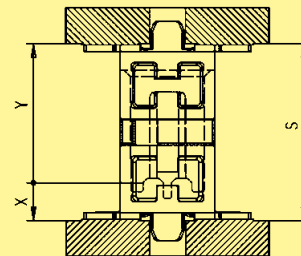

straight male

3.25	9.05	12.3	13.8
1.75	9.05	10.8	12.3
3.25	6.25	9.5	11
1.75	6.25	8	9.5
X	Y	Smin	* Smax

\* Smax = Smin + 1.5 wiping length with additional contact overlap security

#### Extender Card connection

EXTENDER CARD CONFIGURATION

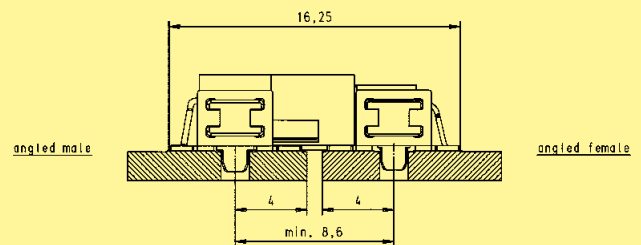

#### Mother-to-Daughtercard connection

angled female

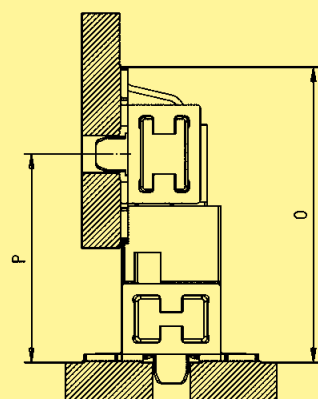

angled male

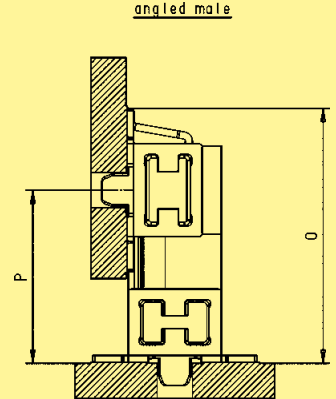

straight male

3.25	10.25	14.08
1.75	8.75	12.58
X	P min.	O

straight female

9.05	10.5	14.33
6.25	7.7	11.53
Y	P min.	O

Mating conditions

Inclination

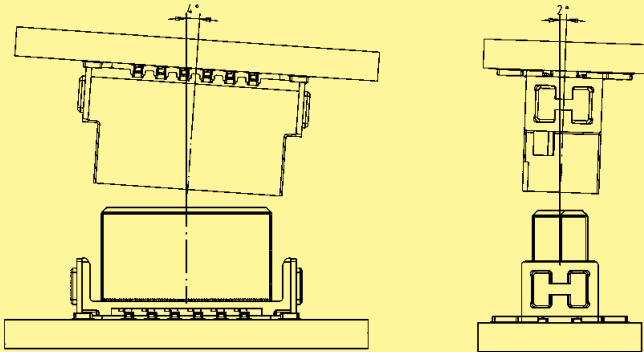

Mismatching

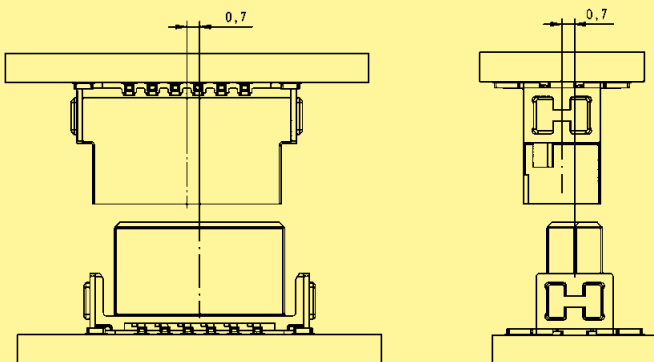

SMT processing notes

The har-flex® SMT connectors meet the highest demands in terms of their processing capabilities.

The connectors are delivered in a tape and reel packaging optimized for automatic assembly machines. A vacuum cover enables the automatic assembly with a vacuum nozzle.

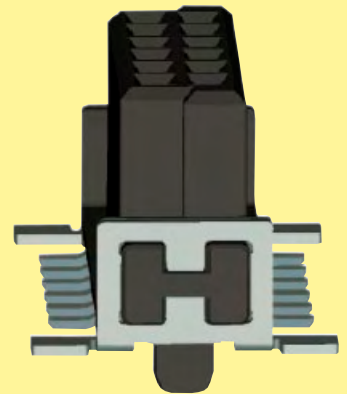

The insulation body material is high temperature resistant, and due to the black colour a secure camera recognition is ensured.

For a reliable SMT solder process, the termination pins are 100 % checked for coplanarity.

Process / Moisture Sensitivity

During the reflow solder process, the connector has to resist extreme variations in temperature. Connectors consist in general of both plastic and metal parts, which have a different behaviour during the solder process. The Process Sensivity and also the Moisture Sensivity are tested according the ECA/IPC/JEDEC J-STD-075 specification.

*Process Sensivity:*

**PSL** means Process Sensivity Level. PSL is a rating used to identify a component that is solder process sensitive. Damages of the connector after three times soldering are not permitted (e.g. melted edges).

*Moisture Sensivity:*

**MSL** means Moisture Sensivity Level. MSL is a rating indicating a component's susceptibility to damage due to absorbed moisture during storage. Damages of the connector after storage in damp heat and three times soldering are not permitted (e.g. blisters).

The har-flex® connectors are rated with **PSL R0** and **MSL 1**. This is the maximum possible rating in both categories. The har-flex® connector resists three times soldering at the following conditions without damages:

- min. 150 s beyond 217 °C (liquidus temperature, the melting point of the solder paste)
- min. 30 s beyond classification temperature (240 °C / 245 °C for har-flex®)
- Temperature solder profile according to ECA/IPC/JEDEC J-STD-075
- For MSL test, a storage of 168 hours at 85 °C and 85 % rel. humidity was carried out

As the result, the har-flex® connectors are not process sensitive and not moisture sensitive according to ECA/IPC/JEDEC J-STD-075.

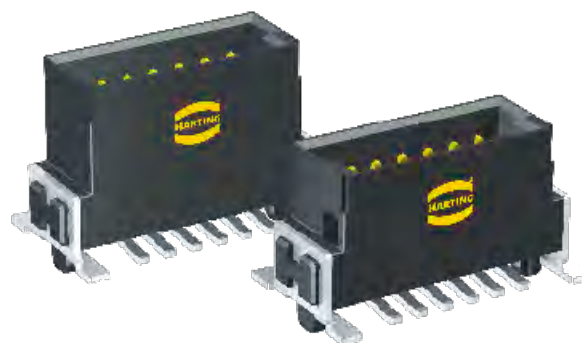

Male connectors, straight

Identification      Number of contacts      Part No.      Dimensions in mm

Male connector, straight,  
stacking heights  
1.75 / 3.25 mm

Identification	Number of contacts	Part No.
6	15 1 . 006 . 601 ...	
8	15 1 . 008 . 601 ...	
10	15 1 . 010 . 601 ...	
12	15 1 . 012 . 601 ...	
14	15 1 . 014 . 601 ...	
16	15 1 . 016 . 601 ...	
18	15 1 . 018 . 601 ...	
20	15 1 . 020 . 601 ...	
22	15 1 . 022 . 601 ...	
24	15 1 . 024 . 601 ...	
26	15 1 . 026 . 601 ...	
28	15 1 . 028 . 601 ...	
30	15 1 . 030 . 601 ...	
32	15 1 . 032 . 601 ...	
34	15 1 . 034 . 601 ...	
36	15 1 . 036 . 601 ...	
38	15 1 . 038 . 601 ...	
40	15 1 . 040 . 601 ...	
42	15 1 . 042 . 601 ...	
44	15 1 . 044 . 601 ...	
46	15 1 . 046 . 601 ...	
48	15 1 . 048 . 601 ...	
50	15 1 . 050 . 601 ...	
52	15 1 . 052 . 601 ...	
54	15 1 . 054 . 601 ...	
56	15 1 . 056 . 601 ...	
58	15 1 . 058 . 601 ...	
60	15 1 . 060 . 601 ...	
62	15 1 . 062 . 601 ...	
64	15 1 . 064 . 601 ...	
66	15 1 . 066 . 601 ...	
68	15 1 . 068 . 601 ...	
70	15 1 . 070 . 601 ...	
72	15 1 . 072 . 601 ...	
74	15 1 . 074 . 601 ...	
76	15 1 . 076 . 601 ...	
78	15 1 . 078 . 601 ...	
80	15 1 . 080 . 601 ...	
82	15 1 . 082 . 601 ...	
84	15 1 . 084 . 601 ...	
86	15 1 . 086 . 601 ...	
88	15 1 . 088 . 601 ...	
90	15 1 . 090 . 601 ...	
92	15 1 . 092 . 601 ...	
94	15 1 . 094 . 601 ...	
96	15 1 . 096 . 601 ...	
98	15 1 . 098 . 601 ...	
100	15 1 . 100 . 601 ...	

A	B	C	D	E	F
2.54	6.96	8.89	5.76	4.76	6.56
3.81	8.23	10.16	7.03	6.03	7.83
5.08	9.50	11.43	8.30	7.30	9.10
6.35	10.77	12.70	9.57	8.57	10.37
7.62	12.04	13.97	10.84	9.84	11.64
8.89	13.31	15.24	12.11	11.11	12.91
10.16	14.58	16.51	13.38	12.38	14.18
11.43	15.85	17.78	14.65	13.65	15.45
12.70	17.12	19.05	15.92	14.92	16.72
13.97	18.39	20.32	17.19	16.19	17.99
15.24	19.66	21.59	18.46	17.46	19.26
16.51	20.93	22.86	19.73	18.73	20.53
17.78	22.20	24.13	21.00	20.00	21.80
19.05	23.47	25.40	22.27	21.27	23.07
20.32	24.74	26.67	23.54	22.54	24.34
21.59	26.01	27.94	24.81	23.81	25.61
22.86	27.28	29.21	26.08	25.08	26.88
24.13	28.55	30.48	27.35	26.35	28.15
25.40	29.82	31.75	28.62	27.62	29.42
26.67	31.09	33.02	29.89	28.89	30.69
27.94	32.36	34.29	31.16	30.16	31.96
29.21	33.63	35.56	32.43	31.43	33.23
30.48	34.90	36.83	33.70	32.70	34.50
31.75	36.17	38.10	34.97	33.97	35.77
33.02	37.44	39.37	36.24	35.24	37.04
34.29	38.71	40.64	37.51	36.51	38.31
35.56	39.98	41.91	38.78	37.78	39.58
36.83	41.25	43.18	40.05	39.05	40.85
38.10	42.52	44.45	41.32	40.32	42.12
39.37	43.79	45.72	42.59	41.59	43.39
40.64	45.06	46.99	43.86	42.86	44.66
41.91	46.33	48.26	45.13	44.13	45.93
43.18	47.60	49.53	46.40	45.40	47.20
44.45	48.87	50.80	47.67	46.67	48.47
45.72	50.14	52.07	48.94	47.94	49.74
46.99	51.41	53.34	50.21	49.21	51.01
48.26	52.68	54.61	51.48	50.48	52.28
49.53	53.95	55.88	52.75	51.75	53.55
50.80	55.22	57.15	54.02	53.02	54.82
52.07	56.49	58.42	55.29	54.29	56.09
53.34	57.76	59.69	56.56	55.56	57.36
54.61	59.03	60.96	57.83	56.83	58.63
55.88	60.30	62.23	59.10	58.10	59.90
57.15	61.57	63.50	60.37	59.37	61.17
58.42	62.84	64.77	61.64	60.64	62.44
59.69	64.11	66.04	62.91	61.91	63.71
60.96	65.38	67.31	64.18	63.18	64.98
62.23	66.65	68.58	65.45	64.45	66.25

Please insert digit for stacking height

1.75 mm ▶ 1  
3.25 mm ▶ 2

for performance level 1  
for performance level S4  
for performance level 2

2  
5  
6

333  
000

for samples  
for 280 pieces on reel



Male connectors, straight

Identification

Drawing

Dimensions in mm

Dimensions

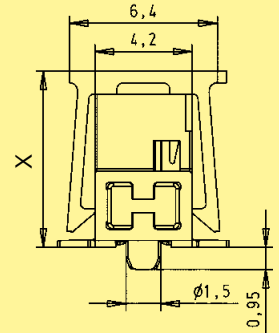
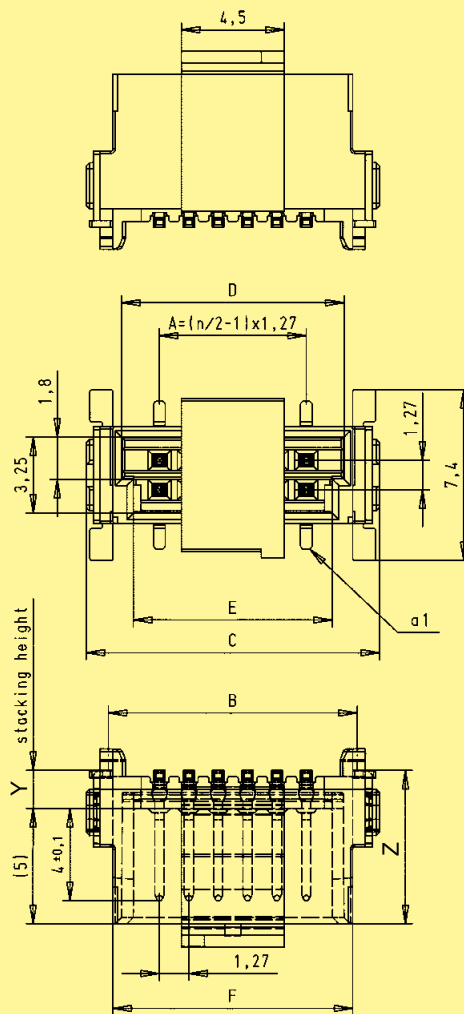

stacking height Y	X	Z
1.75	7.6	6.6
3.25	9.1	8.1

PCB layout

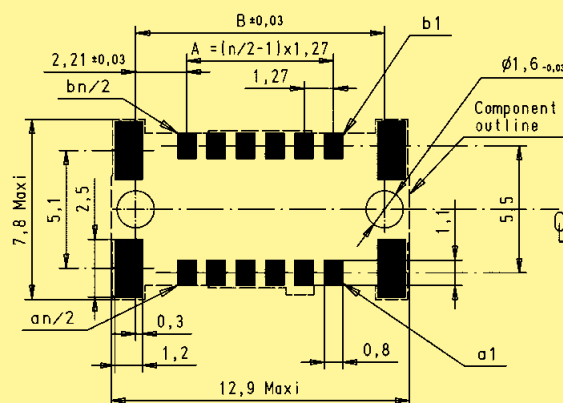



Female connectors, straight

Identification                      Number of contacts                      Part No.                      Dimensions in mm

Female connector, straight, stacking heights 6.25 / 9.05 mm

6	15 2 . 006 . 601 . . .
8	15 2 . 008 . 601 . . .
10	15 2 . 010 . 601 . . .
12	15 2 . 012 . 601 . . .
14	15 2 . 014 . 601 . . .
16	15 2 . 016 . 601 . . .
18	15 2 . 018 . 601 . . .
20	15 2 . 020 . 601 . . .
22	15 2 . 022 . 601 . . .
24	15 2 . 024 . 601 . . .
26	15 2 . 026 . 601 . . .
28	15 2 . 028 . 601 . . .
30	15 2 . 030 . 601 . . .
32	15 2 . 032 . 601 . . .
34	15 2 . 034 . 601 . . .
36	15 2 . 036 . 601 . . .
38	15 2 . 038 . 601 . . .
40	15 2 . 040 . 601 . . .
42	15 2 . 042 . 601 . . .
44	15 2 . 044 . 601 . . .
46	15 2 . 046 . 601 . . .
48	15 2 . 048 . 601 . . .
50	15 2 . 050 . 601 . . .
52	15 2 . 052 . 601 . . .
54	15 2 . 054 . 601 . . .
56	15 2 . 056 . 601 . . .
58	15 2 . 058 . 601 . . .
60	15 2 . 060 . 601 . . .
62	15 2 . 062 . 601 . . .
64	15 2 . 064 . 601 . . .
66	15 2 . 066 . 601 . . .
68	15 2 . 068 . 601 . . .
70	15 2 . 070 . 601 . . .
72	15 2 . 072 . 601 . . .
74	15 2 . 074 . 601 . . .
76	15 2 . 076 . 601 . . .
78	15 2 . 078 . 601 . . .
80	15 2 . 080 . 601 . . .
82	15 2 . 082 . 601 . . .
84	15 2 . 084 . 601 . . .
86	15 2 . 086 . 601 . . .
88	15 2 . 088 . 601 . . .
90	15 2 . 090 . 601 . . .
92	15 2 . 092 . 601 . . .
94	15 2 . 094 . 601 . . .
96	15 2 . 096 . 601 . . .
98	15 2 . 098 . 601 . . .
100	15 2 . 100 . 601 . . .

A	B	C	D	E
2.54	6.96	8.89	5.56	4.56
3.81	8.23	10.16	6.83	5.83
5.08	9.50	11.43	8.10	7.10
6.35	10.77	12.70	9.37	8.37
7.62	12.04	13.97	10.64	9.64
8.89	13.31	15.24	11.91	10.91
10.16	14.58	16.51	13.18	12.18
11.43	15.85	17.78	14.45	13.45
12.70	17.12	19.05	15.72	14.72
13.97	18.39	20.32	16.99	15.99
15.24	19.66	21.59	18.26	17.26
16.51	20.93	22.86	19.53	18.53
17.78	22.20	24.13	20.80	19.80
19.05	23.47	25.40	22.07	21.07
20.32	24.74	26.67	23.34	22.34
21.59	26.01	27.94	24.61	23.61
22.86	27.28	29.21	25.88	24.88
24.13	28.55	30.48	27.15	26.15
25.40	29.82	31.75	28.42	27.42
26.67	31.09	33.02	29.69	28.69
27.94	32.36	34.29	30.96	29.96
29.21	33.63	35.56	32.23	31.23
30.48	34.90	36.83	33.50	32.50
31.75	36.17	38.10	34.77	33.77
33.02	37.44	39.37	36.04	35.04
34.29	38.71	40.64	37.31	36.31
35.56	39.98	41.91	38.58	37.58
36.83	41.25	43.18	39.85	38.85
38.10	42.52	44.45	41.12	40.12
39.37	43.79	45.72	42.39	41.39
40.64	45.06	46.99	43.66	42.66
41.91	46.33	48.26	44.93	43.93
43.18	47.60	49.53	46.20	45.20
44.45	48.87	50.80	47.47	46.47
45.72	50.14	52.07	48.74	47.74
46.99	51.41	53.34	50.01	49.01
48.26	52.68	54.61	51.28	50.28
49.53	53.95	55.88	52.55	51.55
50.80	55.22	57.15	53.82	52.82
52.07	56.49	58.42	55.09	54.09
53.34	57.76	59.69	56.36	55.36
54.61	59.03	60.96	57.63	56.63
55.88	60.30	62.23	58.90	57.90
57.15	61.57	63.50	60.17	59.17
58.42	62.84	64.77	61.44	60.44
59.69	64.11	66.04	62.71	61.71
60.96	65.38	67.31	63.98	62.98
62.23	66.65	68.58	65.25	64.25

Please insert digit for stacking height

6.25 mm ▶ 1  
9.05 mm ▶ 2

for performance level 1  
for performance level S4  
for performance level 2

2  
5  
6

333  
000

for samples  
for 280 pieces on reel





available  
Q2 / 2012



Male connectors, angled

Identification      Number of contacts      Part No.      Dimensions in mm

Male connector,  
angled

Number of contacts	Part No.
6	15 15 006 . 601 ...
8	15 15 008 . 601 ...
10	15 15 010 . 601 ...
12	15 15 012 . 601 ...
14	15 15 014 . 601 ...
16	15 15 016 . 601 ...
18	15 15 018 . 601 ...
20	15 15 020 . 601 ...
22	15 15 022 . 601 ...
24	15 15 024 . 601 ...
26	15 15 026 . 601 ...
28	15 15 028 . 601 ...
30	15 15 030 . 601 ...
32	15 15 032 . 601 ...
34	15 15 034 . 601 ...
36	15 15 036 . 601 ...
38	15 15 038 . 601 ...
40	15 15 040 . 601 ...
42	15 15 042 . 601 ...
44	15 15 044 . 601 ...
46	15 15 046 . 601 ...
48	15 15 048 . 601 ...
50	15 15 050 . 601 ...
52	15 15 052 . 601 ...
54	15 15 054 . 601 ...
56	15 15 056 . 601 ...
58	15 15 058 . 601 ...
60	15 15 060 . 601 ...
62	15 15 062 . 601 ...
64	15 15 064 . 601 ...
66	15 15 066 . 601 ...
68	15 15 068 . 601 ...
70	15 15 070 . 601 ...
72	15 15 072 . 601 ...
74	15 15 074 . 601 ...
76	15 15 076 . 601 ...
78	15 15 078 . 601 ...
80	15 15 080 . 601 ...
82	15 15 082 . 601 ...
84	15 15 084 . 601 ...
86	15 15 086 . 601 ...
88	15 15 088 . 601 ...
90	15 15 090 . 601 ...
92	15 15 092 . 601 ...
94	15 15 094 . 601 ...
96	15 15 096 . 601 ...
98	15 15 098 . 601 ...
100	15 15 100 . 601 ...

A	B	C	D	E
2.54	6.96	8.89	5.76	4.76
3.81	8.23	10.16	7.03	6.03
5.08	9.50	11.43	8.30	7.30
6.35	10.77	12.70	9.57	8.57
7.62	12.04	13.97	10.84	9.84
8.89	13.31	15.24	12.11	11.11
10.16	14.58	16.51	13.38	12.38
11.43	15.85	17.78	14.65	13.65
12.70	17.12	19.05	15.92	14.92
13.97	18.39	20.32	17.19	16.19
15.24	19.66	21.59	18.46	17.46
16.51	20.93	22.86	19.73	18.73
17.78	22.20	24.13	21.00	20.00
19.05	23.47	25.40	22.27	21.27
20.32	24.74	26.67	23.54	22.54
21.59	26.01	27.94	24.81	23.81
22.86	27.28	29.21	26.08	25.08
24.13	28.55	30.48	27.35	26.35
25.40	29.82	31.75	28.62	27.62
26.67	31.09	33.02	29.89	28.89
27.94	32.36	34.29	31.16	30.16
29.21	33.63	35.56	32.43	31.43
30.48	34.90	36.83	33.70	32.70
31.75	36.17	38.10	34.97	33.97
33.02	37.44	39.37	36.24	35.24
34.29	38.71	40.64	37.51	36.51
35.56	39.98	41.91	38.78	37.78
36.83	41.25	43.18	40.05	39.05
38.10	42.52	44.45	41.32	40.32
39.37	43.79	45.72	42.59	41.59
40.64	45.06	46.99	43.86	42.86
41.91	46.33	48.26	45.13	44.13
43.18	47.60	49.53	46.40	45.40
44.45	48.87	50.80	47.67	46.67
45.72	50.14	52.07	48.94	47.94
46.99	51.41	53.34	50.21	49.21
48.26	52.68	54.61	51.48	50.48
49.53	53.95	55.88	52.75	51.75
50.80	55.22	57.15	54.02	53.02
52.07	56.49	58.42	55.29	54.29
53.34	57.76	59.69	56.56	55.56
54.61	59.03	60.96	57.83	56.83
55.88	60.30	62.23	59.10	58.10
57.15	61.57	63.50	60.37	59.37
58.42	62.84	64.77	61.64	60.64
59.69	64.11	66.04	62.91	61.91
60.96	65.38	67.31	64.18	63.18
62.23	66.65	68.58	65.45	64.45

for performance level 1  
for performance level S4  
for performance level 2

2  
5  
6

333  
000

for samples  
for 560 pieces on reel

available  
Q2 / 2012



Male connectors, angled

Identification

Drawing

Dimensions in mm

Dimensions

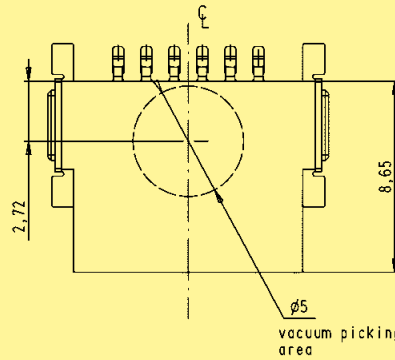
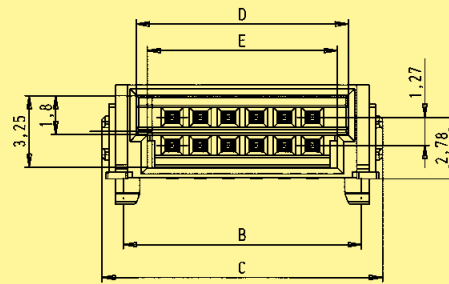
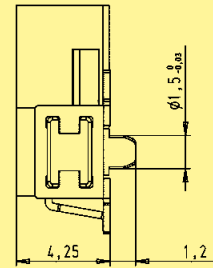
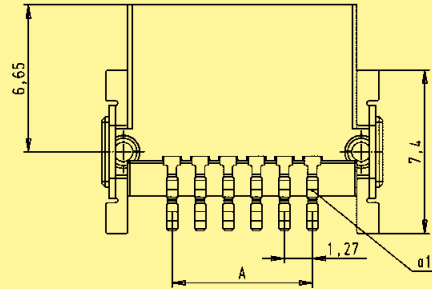

PCB layout

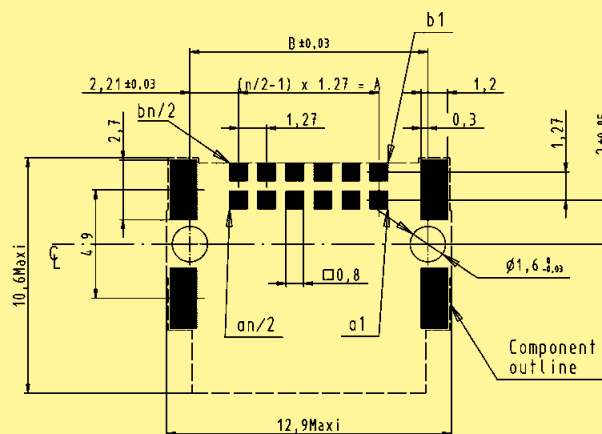

available  
Q2 / 2012



Female connectors, angled

Identification      Number of contacts      Part No.      Dimensions in mm

Female connector,  
angled

Number of contacts	Part No.
6	15 25 006 . 601 ...
8	15 25 008 . 601 ...
10	15 25 010 . 601 ...
12	15 25 012 . 601 ...
14	15 25 014 . 601 ...
16	15 25 016 . 601 ...
18	15 25 018 . 601 ...
20	15 25 020 . 601 ...
22	15 25 022 . 601 ...
24	15 25 024 . 601 ...
26	15 25 026 . 601 ...
28	15 25 028 . 601 ...
30	15 25 030 . 601 ...
32	15 25 032 . 601 ...
34	15 25 034 . 601 ...
36	15 25 036 . 601 ...
38	15 25 038 . 601 ...
40	15 25 040 . 601 ...
42	15 25 042 . 601 ...
44	15 25 044 . 601 ...
46	15 25 046 . 601 ...
48	15 25 048 . 601 ...
50	15 25 050 . 601 ...
52	15 25 052 . 601 ...
54	15 25 054 . 601 ...
56	15 25 056 . 601 ...
58	15 25 058 . 601 ...
60	15 25 060 . 601 ...
62	15 25 062 . 601 ...
64	15 25 064 . 601 ...
66	15 25 066 . 601 ...
68	15 25 068 . 601 ...
70	15 25 070 . 601 ...
72	15 25 072 . 601 ...
74	15 25 074 . 601 ...
76	15 25 076 . 601 ...
78	15 25 078 . 601 ...
80	15 25 080 . 601 ...
82	15 25 082 . 601 ...
84	15 25 084 . 601 ...
86	15 25 086 . 601 ...
88	15 25 088 . 601 ...
90	15 25 090 . 601 ...
92	15 25 092 . 601 ...
94	15 25 094 . 601 ...
96	15 25 096 . 601 ...
98	15 25 098 . 601 ...
100	15 25 100 . 601 ...

A	B	C	D	E
2.54	6.96	8.89	5.56	4.56
3.81	8.23	10.16	6.83	5.83
5.08	9.50	11.43	8.10	7.10
6.35	10.77	12.70	9.37	8.37
7.62	12.04	13.97	10.64	9.64
8.89	13.31	15.24	11.91	10.91
10.16	14.58	16.51	13.18	12.18
11.43	15.85	17.78	14.45	13.45
12.70	17.12	19.05	15.72	14.72
13.97	18.39	20.32	16.99	15.99
15.24	19.66	21.59	18.26	17.26
16.51	20.93	22.86	19.53	18.53
17.78	22.20	24.13	20.80	19.80
19.05	23.47	25.40	22.07	21.07
20.32	24.74	26.67	23.34	22.34
21.59	26.01	27.94	24.61	23.61
22.86	27.28	29.21	25.88	24.88
24.13	28.55	30.48	27.15	26.15
25.40	29.82	31.75	28.42	27.42
26.67	31.09	33.02	29.69	28.69
27.94	32.36	34.29	30.96	29.96
29.21	33.63	35.56	32.23	31.23
30.48	34.90	36.83	33.50	32.50
31.75	36.17	38.10	34.77	33.77
33.02	37.44	39.37	36.04	35.04
34.29	38.71	40.64	37.31	36.31
35.56	39.98	41.91	38.58	37.58
36.83	41.25	43.18	39.85	38.85
38.10	42.52	44.45	41.12	40.12
39.37	43.79	45.72	42.39	41.39
40.64	45.06	46.99	43.66	42.66
41.91	46.33	48.26	44.93	43.93
43.18	47.60	49.53	46.20	45.20
44.45	48.87	50.80	47.47	46.47
45.72	50.14	52.07	48.74	47.74
46.99	51.41	53.34	50.01	49.01
48.26	52.68	54.61	51.28	50.28
49.53	53.95	55.88	52.55	51.55
50.80	55.22	57.15	53.82	52.82
52.07	56.49	58.42	55.09	54.09
53.34	57.76	59.69	56.36	55.36
54.61	59.03	60.96	57.63	56.63
55.88	60.30	62.23	58.90	57.90
57.15	61.57	63.50	60.17	59.17
58.42	62.84	64.77	61.44	60.44
59.69	64.11	66.04	62.71	61.71
60.96	65.38	67.31	63.98	62.98
62.23	66.65	68.58	65.25	64.25

for performance level 1  
for performance level S4  
for performance level 2

2  
5  
6

333  
000

for samples  
for 560 pieces on reel

available  
Q2 / 2012



Female connectors, angled

Identification

Drawing

Dimensions in mm

Dimensions

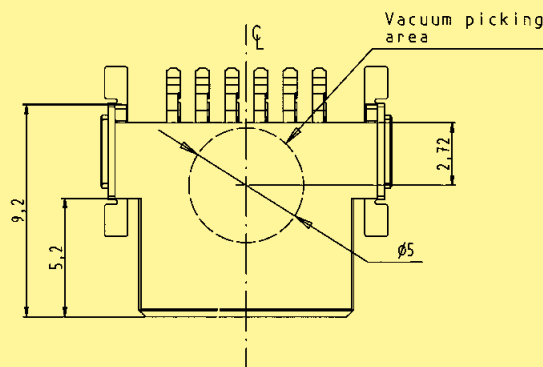
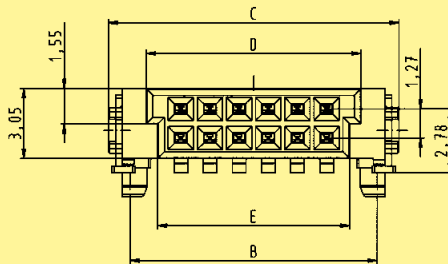
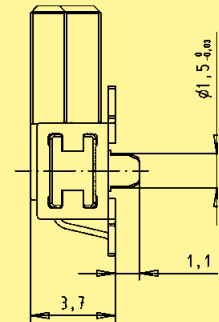
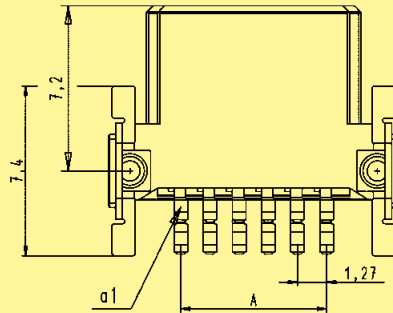

PCB layout

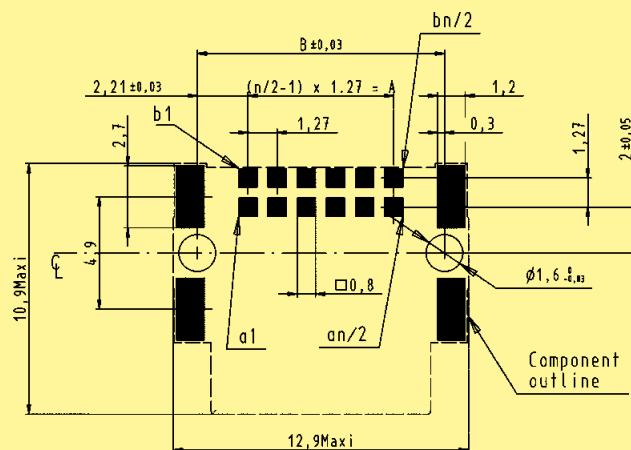



Female connectors, IDC

Identification      Number of contacts      Part No.      Dimensions in mm

Female connector, IDC in a tray packaging

6	15 29 006	. 50 . 000
8	15 29 008	. 50 . 000
10	15 29 010	. 50 . 000
12	15 29 012	. 50 . 000
14	15 29 014	. 50 . 000
16	15 29 016	. 50 . 000
18	15 29 018	. 50 . 000
20	15 29 020	. 50 . 000
22	15 29 022	. 50 . 000
24	15 29 024	. 50 . 000
26	15 29 026	. 50 . 000
28	15 29 028	. 50 . 000
30	15 29 030	. 50 . 000
32	15 29 032	. 50 . 000
34	15 29 034	. 50 . 000
36	15 29 036	. 50 . 000
38	15 29 038	. 50 . 000
40	15 29 040	. 50 . 000
42	15 29 042	. 50 . 000
44	15 29 044	. 50 . 000
46	15 29 046	. 50 . 000
48	15 29 048	. 50 . 000
50	15 29 050	. 50 . 000
52	15 29 052	. 50 . 000
54	15 29 054	. 50 . 000
56	15 29 056	. 50 . 000
58	15 29 058	. 50 . 000
60	15 29 060	. 50 . 000
62	15 29 062	. 50 . 000
64	15 29 064	. 50 . 000
66	15 29 066	. 50 . 000
68	15 29 068	. 50 . 000
70	15 29 070	. 50 . 000
72	15 29 072	. 50 . 000
74	15 29 074	. 50 . 000
76	15 29 076	. 50 . 000
78	15 29 078	. 50 . 000
80	15 29 080	. 50 . 000
82	15 29 082	. 50 . 000
84	15 29 084	. 50 . 000
86	15 29 086	. 50 . 000
88	15 29 088	. 50 . 000
90	15 29 090	. 50 . 000
92	15 29 092	. 50 . 000
94	15 29 094	. 50 . 000
96	15 29 096	. 50 . 000
98	15 29 098	. 50 . 000
100	15 29 100	. 50 . 000

A	B	C	D	E
2.54	11.59	5.56	4.56	15.00
3.81	12.86	6.83	5.83	15.00
5.08	14.13	8.10	7.10	15.00
6.35	15.40	9.37	8.37	15.00
7.62	16.67	10.64	9.64	15.00
8.89	17.94	11.91	10.91	15.00
10.16	19.21	13.18	12.18	15.00
11.43	20.48	14.45	13.45	15.00
12.70	21.75	15.72	14.72	15.00
13.97	23.02	16.99	15.99	15.00
15.24	24.29	18.26	17.26	15.00
16.51	25.56	19.53	18.53	15.00
17.78	26.83	20.80	19.80	15.00
19.05	28.10	22.07	21.07	15.00
20.32	29.37	23.34	22.34	15.00
21.59	30.64	24.61	23.61	15.00
22.86	31.91	25.88	24.88	15.00
24.13	33.18	27.15	26.15	15.00
25.40	34.45	28.42	27.42	15.00
26.67	35.72	29.69	28.69	15.00
27.94	36.99	30.96	29.96	15.00
29.21	38.26	32.23	31.23	15.00
30.48	39.53	33.50	32.50	15.00
31.75	40.80	34.77	33.77	15.00
33.02	42.07	36.04	35.04	15.00
34.29	43.34	37.31	36.31	15.00
35.56	44.61	38.58	37.58	15.00
36.83	45.88	39.85	38.85	16.20
38.10	47.15	41.12	40.12	16.20
39.37	48.42	42.39	41.39	16.20
40.64	49.69	43.66	42.66	16.20
41.91	50.96	44.93	43.93	16.20
43.18	52.23	46.20	45.20	16.20
44.45	53.50	47.47	46.47	16.20
45.72	54.77	48.74	47.74	16.20
46.99	56.04	50.01	49.01	16.20
48.26	57.31	51.28	50.28	16.20
49.53	58.58	52.55	51.55	16.20
50.80	59.85	53.82	52.82	16.20
52.07	61.12	55.09	54.09	16.20
53.34	62.39	56.36	55.36	16.20
54.61	63.66	57.63	56.63	16.20
55.88	64.93	58.90	57.90	16.20
57.15	66.20	60.17	59.17	16.20
58.42	67.47	61.44	60.44	16.20
59.69	68.74	62.71	61.71	16.20
60.96	70.01	63.98	62.98	16.20
62.23	71.28	65.25	64.25	16.20

Please insert digit

- for performance level 1 ▶ 2
- for performance level S4 ▶ 5
- for performance level 2 ▶ 6

without strain relief  
with strain relief

1  
2



Female connectors, IDC

Identification

Drawing

Dimensions in mm

Dimensions

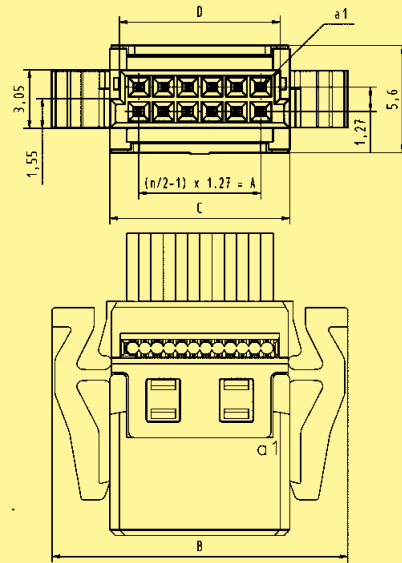

PVC FLAT CABLE : AWG 30/1 (solid)  
 AWG 30/7 (stranded)  
 PTFE FLAT CABLE : AWG 30/1 (Solid)  
 ø0.55 mini - ø0.75 maxi

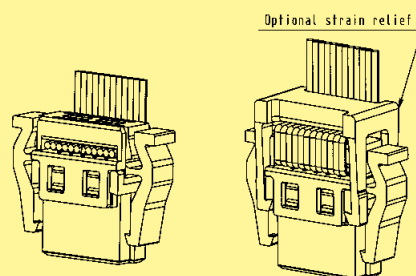
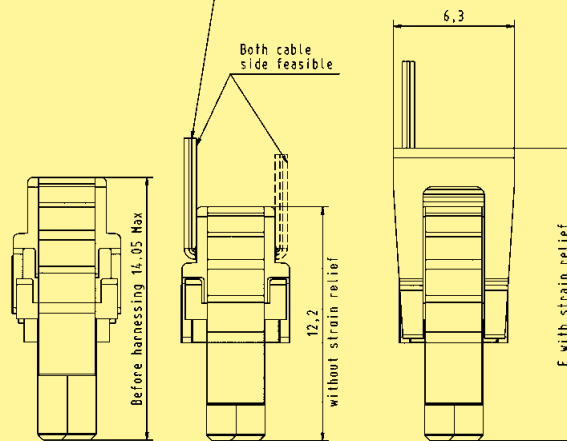



Strain reliefs for female connectors,  
IDC

Identification	Number of contacts	Part No.	Dimensions in mm
Strain reliefs for female connectors, IDC	6	15 29 006 0503 000	A
	8	15 29 008 0503 000	7.31
	10	15 29 010 0503 000	8.58
	12	15 29 012 0503 000	9.85
	14	15 29 014 0503 000	11.12
	16	15 29 016 0503 000	12.39
	18	15 29 018 0503 000	13.66
	20	15 29 020 0503 000	14.93
	22	15 29 022 0503 000	16.20
	24	15 29 024 0503 000	17.47
	26	15 29 026 0503 000	18.74
	28	15 29 028 0503 000	20.01
	30	15 29 030 0503 000	21.28
	32	15 29 032 0503 000	22.55
	34	15 29 034 0503 000	23.82
	36	15 29 036 0503 000	25.09
	38	15 29 038 0503 000	26.36
	40	15 29 040 0503 000	27.63
	42	15 29 042 0503 000	28.90
	44	15 29 044 0503 000	30.17
	46	15 29 046 0503 000	31.44
	48	15 29 048 0503 000	32.71
	50	15 29 050 0503 000	33.98
	52	15 29 052 0503 000	35.25
	54	15 29 054 0503 000	36.52
	56	15 29 056 0503 000	37.79
	58	15 29 058 0503 000	39.06
	60	15 29 060 0503 000	40.33
	62	15 29 062 0503 000	41.60
	64	15 29 064 0503 000	42.87
	66	15 29 066 0503 000	44.14
	68	15 29 068 0503 000	45.41
	70	15 29 070 0503 000	46.68
	72	15 29 072 0503 000	47.95
	74	15 29 074 0503 000	49.22
	76	15 29 076 0503 000	50.49
	78	15 29 078 0503 000	51.76
	80	15 29 080 0503 000	53.03
82	15 29 082 0503 000	54.30	
84	15 29 084 0503 000	55.57	
86	15 29 086 0503 000	56.84	
88	15 29 088 0503 000	58.11	
90	15 29 090 0503 000	59.38	
92	15 29 092 0503 000	60.65	
94	15 29 094 0503 000	61.92	
96	15 29 096 0503 000	63.19	
98	15 29 098 0503 000	64.46	
100	15 29 100 0503 000	65.73	
			67.00





Strain reliefs for female connectors, IDC

Identification

Drawing

Dimensions in mm

Dimensions

6 – 58 contacts

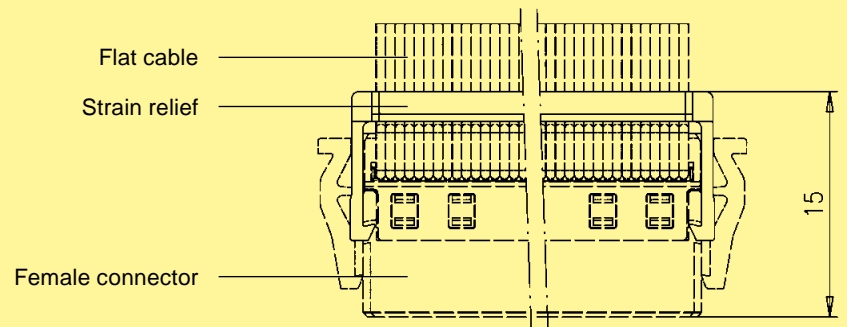
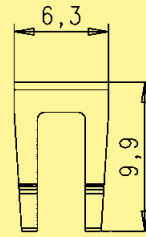
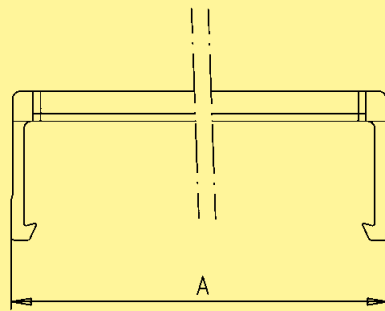

60 – 100 contacts

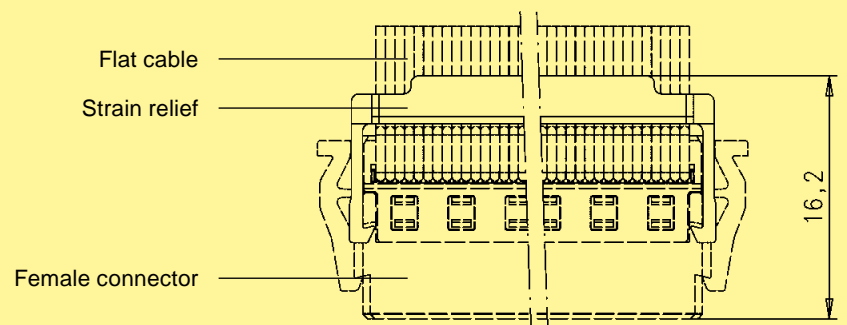
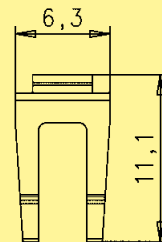
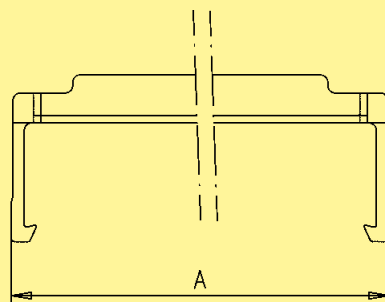





Please send me further information:

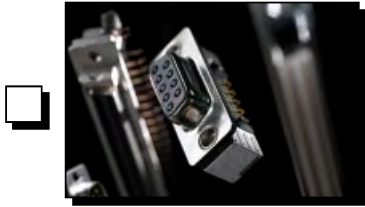

**Interface Connectors**



**Device Connectivity**



**Industrial Connectors Han®**

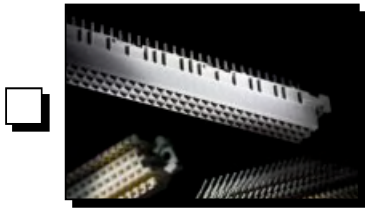

**Connectors  
DIN 41612**



**Intelligent Network Solutions**



**Coaxial and Metric Connectors**



**Application brochure**

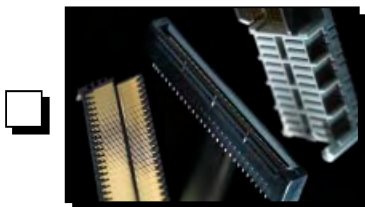

**TCA Connectors**

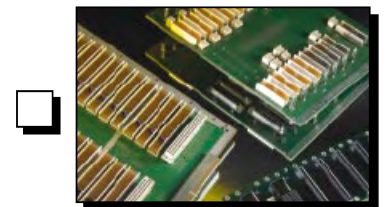

**High Speed Backplanes**

Sender:

Company: \_\_\_\_\_

Department: \_\_\_\_\_

Name: \_\_\_\_\_

Prenome: \_\_\_\_\_

Function: \_\_\_\_\_

Street: \_\_\_\_\_

Postcode/Town: \_\_\_\_\_

Country: \_\_\_\_\_

Phone: \_\_\_\_\_

Fax: \_\_\_\_\_

E-Mail: \_\_\_\_\_

***Please send it by post or fax to your local HARTING representatives (see page addresses) or visit us under [www.HARTING.com](http://www.HARTING.com).***

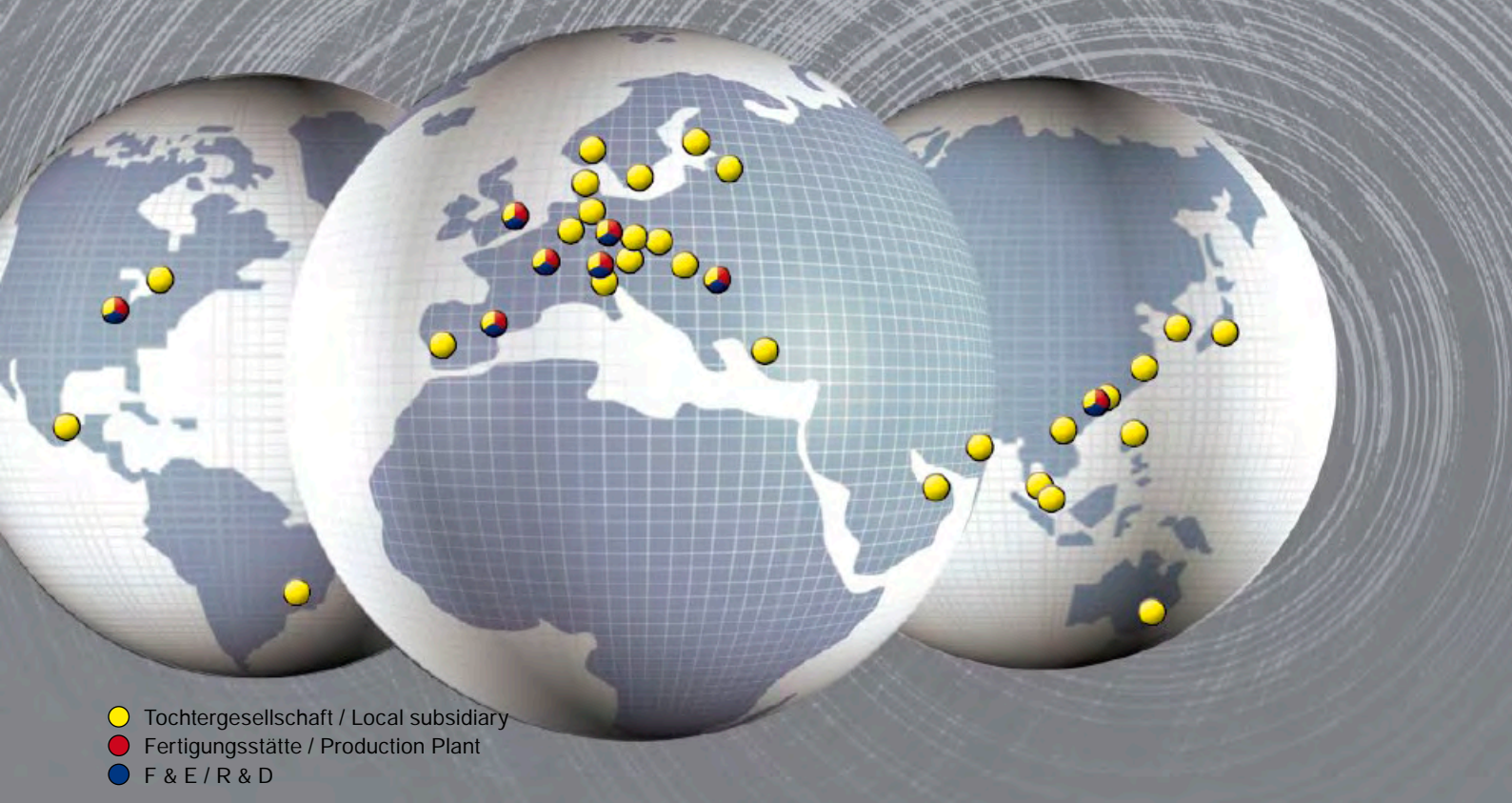

- Tochtergesellschaft / Local subsidiary
- Fertigungsstätte / Production Plant
- F & E / R & D

## Sales Network – worldwide



### Albania

see Eastern Europe

### Argentina

Condelectric S.A.  
Hipólito Yrigoyen 2591, 1640 - Martínez  
Buenos Aires – Argentina  
Phone +54 11 4836 1053  
Fax +54 11 4836 1053  
comercial@condelectric.com.ar

### Armenia

see Eastern Europe

### Australia

HARTING Pty Ltd  
Suite 11 / 2 Enterprise Drive  
Bundoora 3083, AUS-Victoria  
Phone +61 3 9466 7088  
Fax +61 3 9466 7099  
au@HARTING.com  
www.HARTING.com.au

### Austria

HARTING Ges.m.b.H.  
Deutschstraße 19, A-1230 Wien  
Phone +431 6162121  
Fax +431 6162121-21  
at@HARTING.com  
www.HARTING.at

### Azerbaijan

see Eastern Europe

### Bahrain

see United Arab Emirates

### Belgium

HARTING N.V./S.A.  
Z.3 Doornveld 23, B-1731 Zellik  
Phone +32 2 466 0190  
Fax +32 2 466 7855  
be@HARTING.com  
www.HARTING.be

### Bosnia and Herzegovina

see Eastern Europe

### Brazil

HARTING Ltda.  
Rua Major Paladino 128 –  
Prédio 11  
CEP 05307-000 – São Paulo –  
SP – Brasil  
Phone +55 11 5035 0073  
Fax +55 11 5034 4743  
br@HARTING.com  
www.HARTING.com.br

### Brunei

see Singapore

### Bulgaria

see Eastern Europe

### Canada

HARTING Canada Inc.  
8455 Trans-Canada Hwy., Suite 202  
St. Laurent, QC, H4S1Z1, Canada  
Tel. 855-659-6653, Fax 855-659-6654  
info.ca@HARTING.com  
www.HARTING.ca

### China

HARTING Sales (Shanghai) Limited  
Room 5403, HK New World Tower  
300 Huai Hai Road (M.), Luwan District  
Shanghai 200021, China  
Phone +86 21 6386 2200  
Fax +86 21 6386 8636  
cn@HARTING.com  
www.HARTING.com.cn

### Croatia

see Eastern Europe

### Czech Republic

HARTING s.r.o.  
Mlýnská 2, CZ-160 00 Praha 6  
Phone +420 220 380 460  
Fax +420 220 380 461  
cz@HARTING.com  
www.HARTING.cz

### Denmark

HARTING ApS  
Hjulgagervej 4a  
DK - 7100 Vejle  
Phone +45 70 25 00 32  
Fax +45 75 80 64 99  
dk@HARTING.com  
www.HARTING.com

**Eastern Europe**

HARTING Eastern Europe GmbH  
Bamberger Straße 7  
D-01187 Dresden  
Phone +49 351 4361 760  
Fax +49 351 436 1770  
Eastern.Europe@HARTING.com  
www.HARTING.com

**Estonia**

see Eastern Europe

**Finland**

HARTING Oy  
Teknobulevardi 3-5  
FI-01530 Vantaa  
Phone +358 207 291 510  
Fax +358 207 291 511  
fi@HARTING.com  
www.HARTING.fi

**France**

HARTING France  
181 avenue des Nations, Paris Nord 2  
BP 66058 Tremblay en France  
F-95972 Roissy Charles de Gaulle  
Cédex  
Phone +33 1 4938 3400  
Fax +33 1 4863 2306  
fr@HARTING.com  
www.HARTING.fr

**Germany**

HARTING Deutschland GmbH & Co. KG  
P.O. Box 2451, D-32381 Minden  
Simeons carré 1, D-32427 Minden  
Phone +49 571 8896 0  
Fax +49 571 8896 282  
de@HARTING.com  
www.HARTING-Deutschland.de

**Georgia**

see Eastern Europe

**Great Britain**

HARTING Ltd., Caswell Road  
Brackmills Industrial Estate  
GB-Northampton, NN4 7PW  
Phone +44 1604 827 500  
Fax +44 1604 706 777  
gb@HARTING.com  
www.HARTING.co.uk

**Hong Kong**

HARTING (HK) Limited  
Regional Office Asia Pacific  
3512 Metroplaza Tower 1  
223 Hing Fong Road  
Kwai Fong, N. T., Hong Kong  
Phone +852 2423 7338  
Fax +852 2480 4378  
ap@HARTING.com  
www.HARTING.com.hk

**Hungary**

HARTING Magyarország Kft.  
Fehérvári út 89-95, H-1119 Budapest  
Phone +36 1 205 34 64  
Fax +36 1 205 34 65  
hu@HARTING.com  
www.HARTING.hu

**India**

HARTING India Private Limited  
No. D, 4th Floor, 'Doshi Towers'  
No. 156 Poonamallee High Road  
Kilpauk, Chennai 600 010  
Tamil Nadu, India  
Phone +91 44 435604 15 / 416  
Fax +91 44 435604 17  
in@HARTING.com  
www.HARTING.in

**Indonesia**

see Malaysia

**Israel**

COMTEL  
Israel Electronic Solutions Ltd.  
Bet Hapamon, 20 Hataas st.  
P.O.Box 66  
Kefar-Saba 44425  
Phone +972-9-7677240  
Fax +972-9-7677243  
sales@comtel.co.il  
www.comtel.co.il

**Italy**

HARTING SpA  
Via Dell' Industria 7  
I-20090 Vimodrone (Milano)  
Phone +39 02 250801  
Fax +39 02 2650 597  
it@HARTING.com  
www.HARTING.it

**Japan**

HARTING K. K.  
Yusen Shin-Yokohama 1 Chome Bldg., 2F  
1-7-9, Shin-Yokohama, Kohoku  
Yokohama 222-0033 Japan  
Phone +81 45 476 3456  
Fax +81 45 476 3466  
jp@HARTING.com  
www.HARTING.co.jp

**Jordan**

see United Arab Emirates

**Kazakhstan**

see Eastern Europe

**Kirghizia**

see Eastern Europe

**Korea (South)**

HARTING Korea Limited  
#308 Yatap Leaders Building  
342-1, Yatap-dong, Bundang-gu  
Sungnam-City, Kyunggi-do  
463-828, Republic of Korea  
Phone +82 31 781 4615  
Fax +82 31 781 4616  
kr@HARTING.com  
www.HARTING.co.kr

**Kosovo**

see Eastern Europe

**Kuwait**

see United Arab Emirates

**Latvia**

see Eastern Europe

**Lithuania**

see Eastern Europe

**Macedonia**

see Eastern Europe

**Malaysia (Office)**

HARTING Singapore Pte Ltd  
Malaysia Branch  
11-02 Menara Amcorp  
Jln. Persiaran Barat  
46200 PJ, Sel. D. E., Malaysia  
Phone +60 3 / 7955 6173  
Fax +60 3 / 7955 5126  
sg@HARTING.com

**Montenegro**

see Eastern Europe

**Netherlands**

HARTING B.V.  
Larenweg 44  
NL-5234 KA 's-Hertogenbosch  
Postbus 3526  
NL-5203 DM 's-Hertogenbosch  
Phone +31 736 410 404  
Fax +31 736 440 699  
nl@HARTING.com  
www.HARTINGbv.nl

**New Zealand**

see Australia

**Norway**

HARTING A/S  
Østensjøveien 36, N-0667 Oslo  
Phone +47 22 700 555  
Fax +47 22 700 570  
no@HARTING.com  
www.HARTING.no

**Oman**

see United Arab Emirates

**Philippines**

see Malaysia

## Poland

HARTING Polska Sp. z o. o.  
ul. Kamieńskiego 201-219  
PL-51-126 Wrocław  
Phone +48 71 352 81 71  
Fax +48 71 320 74 44  
pl@HARTING.com  
www.HARTING.pl

## Portugal

HARTING Iberia, S. A.  
Avda. Josep Tarradellas 20-30 4º 6a  
E-08029 Barcelona  
Phone +351 219 673 177  
Fax +351 219 678 457  
es@HARTING.com  
www.HARTING.es/pt

## Qatar

see United Arab Emirates

## Republic of Moldova

see Eastern Europe

## Romania

HARTING Romania SCS  
Europa Unita str. 21  
550018-Sibiu, Romania  
Phone +40 369-102 671  
Fax +40 369-102 622  
ro@HARTING.com  
www.HARTING.com

## Russia

HARTING ZAO  
Maliy Sampsoniyevsky prospect 2A  
194044 Saint Petersburg, Russia  
Phone +7 812 327 6477  
Fax +7 812 327 6478  
ru@HARTING.com  
www.HARTING.ru

## Saudi Arabia

see United Arab Emirates

## Serbia

see Eastern Europe

## Singapore

HARTING Singapore Pte Ltd.  
25 International Business Park  
#04-108 German Centre  
Singapore 609916  
Phone +65 6225 5285  
Fax +65 6225 9947  
sg@HARTING.com  
www.HARTING.sg

## Slovakia

HARTING s.r.o.  
Sales office Slovakia  
J. Simora 5, SK - 940 52 Nové Zámky  
Phone +421 356-493 993  
Fax +421 356-402 114  
sk@HARTING.com  
www.HARTING.sk

## Slovenia

see Eastern Europe

## South Africa

Cabcon Technologies (PTY) Ltd  
P.O. Box 13002, Northmead, 1511  
Phone +27 1184533258  
Fax +27 118454077  
cabcon@mweb.co.za

## Spain

HARTING Iberia S.A.  
Avda. Josep Tarradellas 20-30 4º 6a  
E-08029 Barcelona  
Phone +34 93 363 84 75  
Fax +34 93 419 95 85  
es@HARTING.com  
www.HARTING.es

## Sweden

HARTING AB  
Gustavslundsvägen 141 B 4tr  
S-167 51 Bromma  
Phone +46 8 445 7171  
Fax +46 8 445 7170  
se@HARTING.com  
www.HARTING.se

## Switzerland

HARTING AG  
Industriestrasse 26  
CH-8604 Volketswil  
Phone +41 44 908 20 60  
Fax +41 44 908 20 69  
ch@HARTING.com  
www.HARTING.ch

## Taiwan

HARTING Taiwan Ltd.  
Room 1, 5/F  
495 GuangFu South Road  
RC-110 Taipei, Taiwan  
Phone +886 2 2758 6177  
Fax +886 2 2758 7177  
tw@HARTING.com  
www.HARTING.com.tw

## Tajikistan

see Eastern Europe

## Thailand

see Malaysia

## Turkey

HARTING TURKEI Elektronik Ltd. Şti.  
Barbaros Mah. Dereboyu Cad.  
Fesleğen Sok.  
Uphill Towers, A-1b Kat:8 D:45  
34746 Ataşehir, İstanbul  
Phone +90 216 688 81 00  
Fax +90 216 688 81 01  
tr@HARTING.com  
www.HARTING.com.tr

## Turkmenistan

see Eastern Europe

## United Arab Emirates

HARTING Middle East FZ-LLC  
Knowledge Village, Block 2A, Office F72  
P.O. Box 454372, Dubai  
United Arab Emirates  
Tel. +971 4 453 9737  
Fax +971 4 439 0339  
uae@HARTING.com  
www.HARTING.ae

## Ukraine

see Eastern Europe

## USA

HARTING Inc. of North America  
1370 Bowes Road  
USA-Elgin, Illinois 60123  
Phone +1 (877) 741-1500 (toll free)  
Fax +1 (866) 278-0307 (Inside Sales)  
us@HARTING.com  
www.HARTING-USA.com

## Uzbekistan

see Eastern Europe

## Vietnam

see Singapore

## Distributors – worldwide



Farnell:  
www.farnell.com

RS Components:  
www.rs-components.com

FUTURE Electronics:  
www.futureelectronics.com

## Other countries and general contact



HARTING Electronics GmbH & Co. KG  
P.O. Box 1433  
32328 Espelkamp - Germany  
Phone +49 5772/47-97200  
Fax +49 5772/47-777  
electronics@HARTING.com



**Pushing Performance**

[www.HARTING.com](http://www.HARTING.com)