

THIS DRAWING IS UNPUBLISHED. RELEASED FOR PUBLICATION
 © COPYRIGHT - BY ALL RIGHTS RESERVED.

LOC		DIST		REVISIONS					
H		-		P	LTR	DESCRIPTION	DATE	DWN	APVD
				H1		REVISED PER ECO-11-005294	27APR11	RK	HMR

REFERENCE MATING INTERFACE PATTERN:
 1,27 STAGGERED PITCH x 1,5 ROW-DISTANCE.

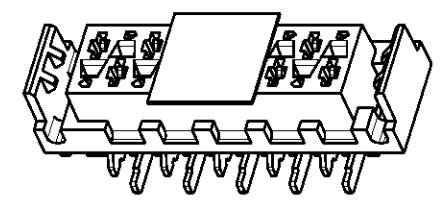
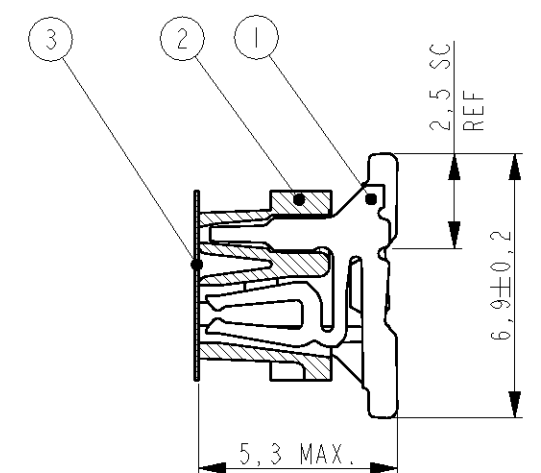
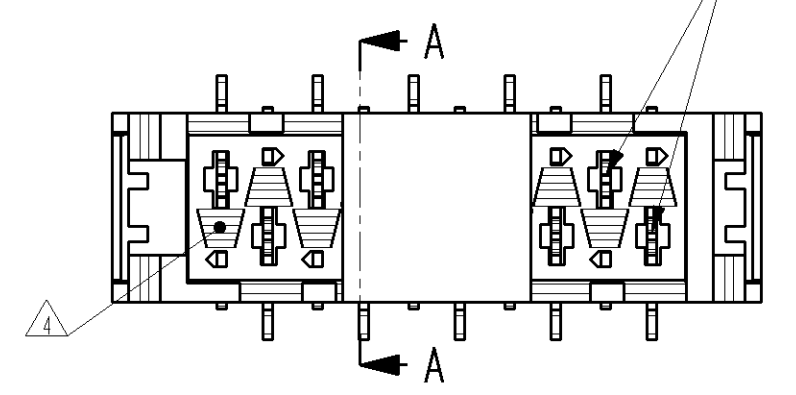

SCALE 3:1

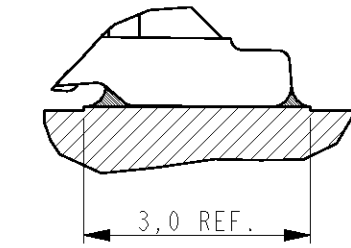

SOLDER DETAIL
SCALE 10:1

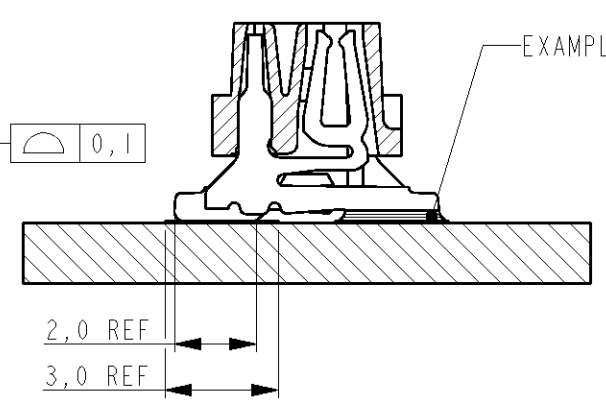

EXAMPLE SOLDER JOINT

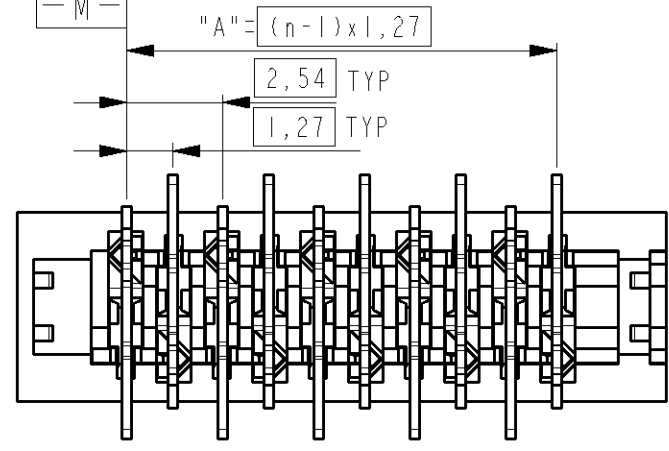
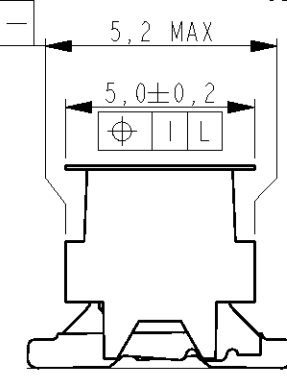
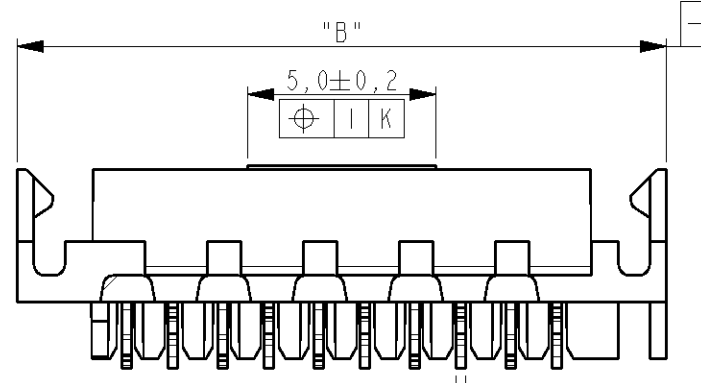
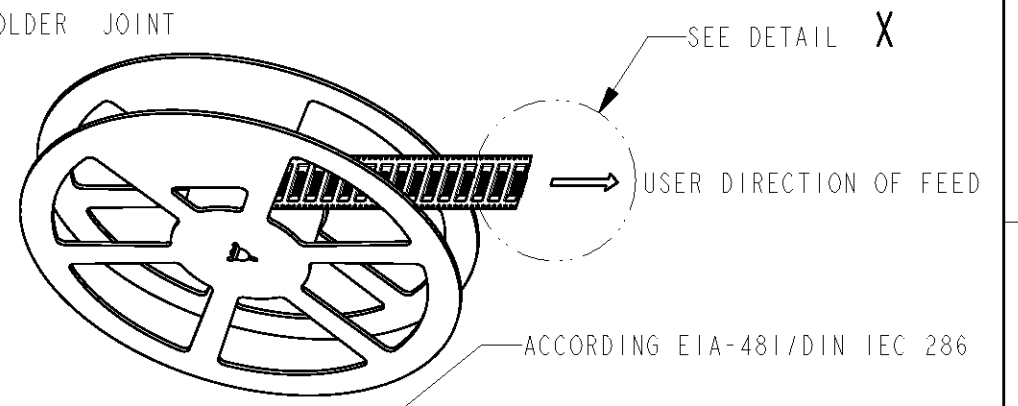

NOTES:

- 1 TAPE FOR VACUUM P&P ONLY FOR DASHNUMBERS 7- 18- 19-
- 2 FOR PACKAGING SEE SHEET 2 AND 3
- 3 WITHOUT VACUUM TAPE.
- 4 CORING-OUTS FOR MANUFACTURING PURPOSE ONLY. SHAPE MAY VARY, BUT IS NOT FUNCTIONAL FOR THE APPLICATION.
- 5 SHOWN IS A 10 POSITION CONNECTOR.

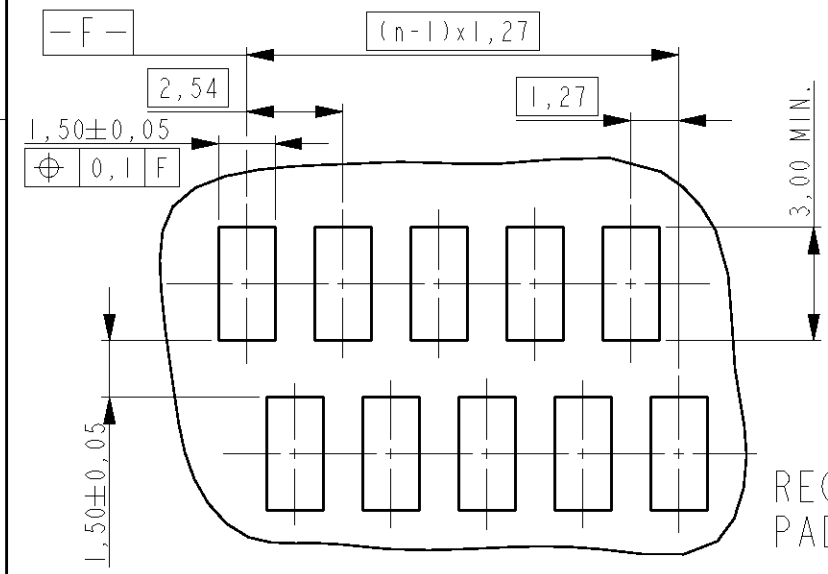

RECOMMENDED PC-BOARD
PAD-LAYOUT TOP VIEW

DIMENSIONS:		TOLERANCES UNLESS OTHERWISE SPECIFIED:	
mm		0 PLC	±-
		1 PLC	±-
		2 PLC	±-
		3 PLC	±-
		4 PLC	±-
		ANGLES	±-
MATERIAL		FINISH	

3	PICK & PLACE TAPE	KAPTON	AMBER TRANSPARENT
2	FEMALE HOUSING	G.F.POLYAMIDE	RED
1	FEMALE CONTACT	PHOSPHOR BRONZE	TIN OVER NICKEL
Item no.	Description	Material	Finish

DWN M. Gosselink		IIDECO1	
CHK -		-	
APVD -		-	
PRODUCT SPEC 108-19052		NAME CONNECTOR, FEMALE-ON-BOARD TOP-ENTRY, SMD, WITH LATCHES, Micro-MaTch	
APPLICATION SPEC -		SIZE A3	
WEIGHT -		CAGE CODE 00779	
CUSTOMER DRAWING		DRAWING NO C-338069	
SCALE 5:1		SHEET 1 OF 3	
REV H1		RESTRICTED TO -	



THIS DRAWING IS UNPUBLISHED.

RELEASED FOR PUBLICATION

© COPYRIGHT - BY

ALL RIGHTS RESERVED.

LOC H DIST -

REVISIONS

P LTR

DESCRIPTION

DATE

DWN

APVD

SEE SHEET 1

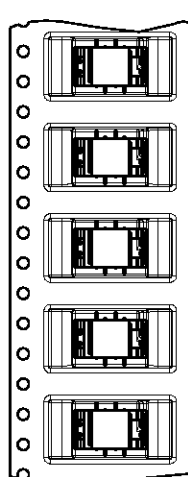

7-338069-4

4 POSITIONS

338069-4

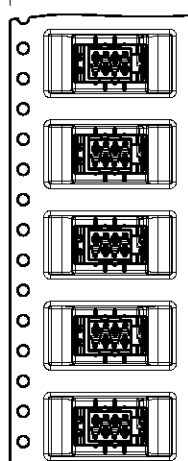

24mm wide tape

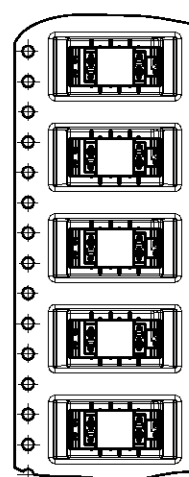

7-338069-6

6 POSITIONS

338069-6

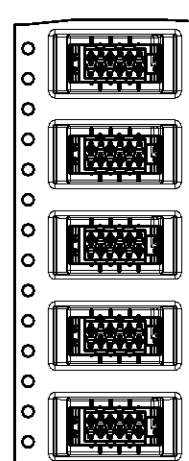

24mm wide tape

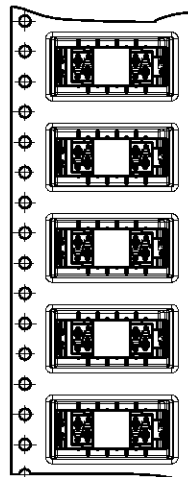

7-338069-8

8 POSITIONS

338069-8

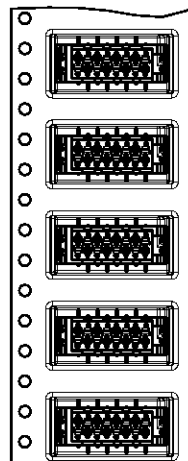

24mm wide tape

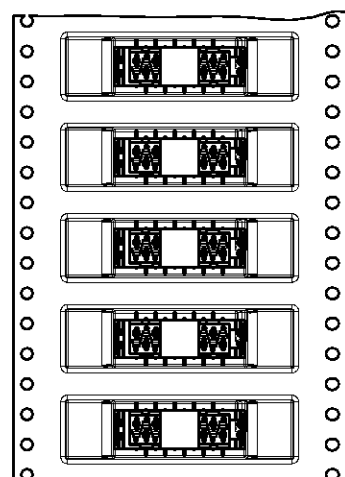

8-338069-0

10 POSITIONS

1-338069-0

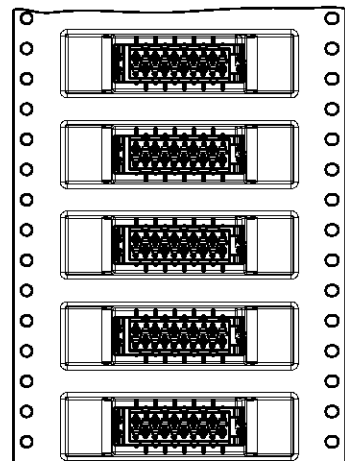

44mm wide tape

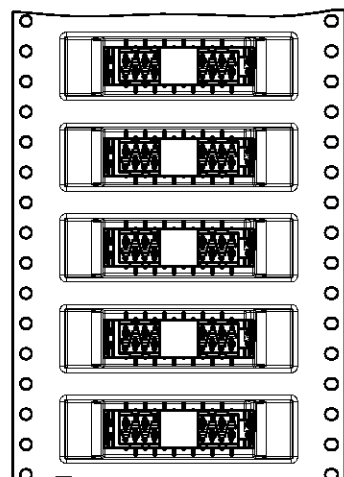

8-338069-2

12 POSITIONS

1-338069-2

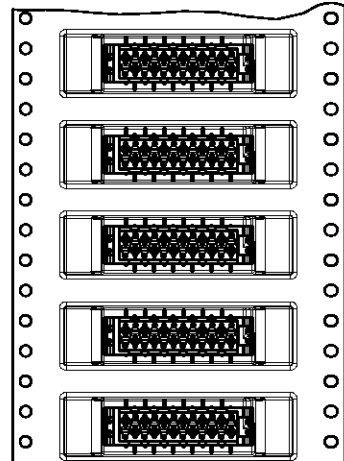

44mm wide tape

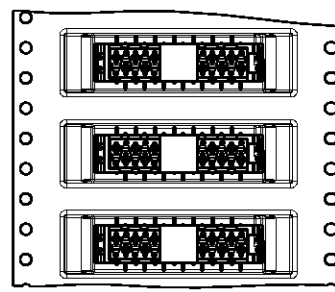

8-338069-4

14 POSITIONS

1-338069-4

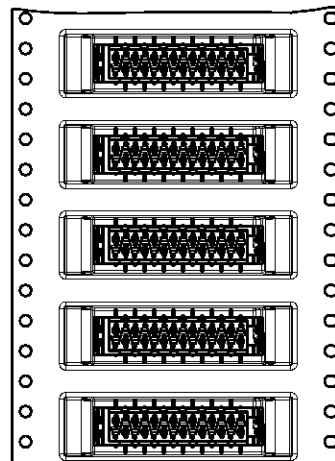

44mm wide tape

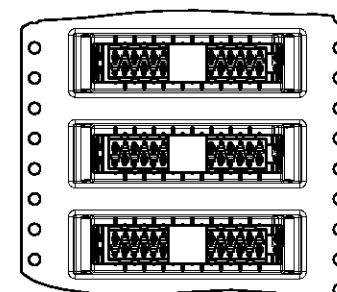

8-338069-6

16 POSITIONS

1-338069-6

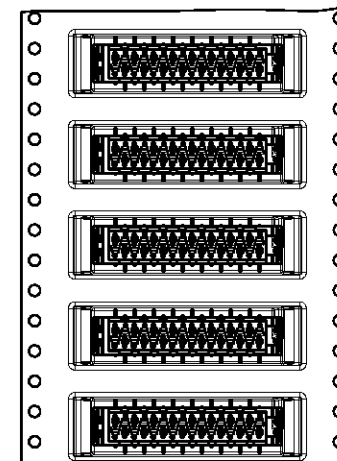

44mm wide tape

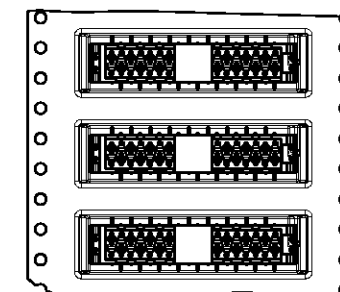

8-338069-8

18 POSITIONS

1-338069-8

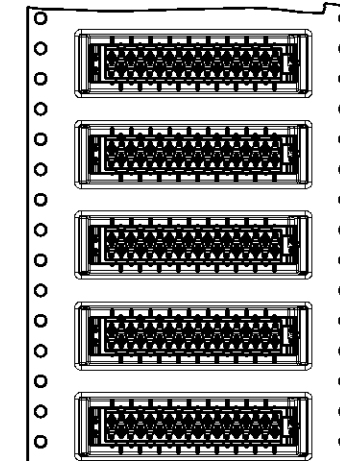

44mm wide tape

DIMENSIONS: mm		TOLERANCES UNLESS OTHERWISE SPECIFIED:		DWN M. Gosselink	IDECON
		0 PLC	±-	CHK	-
		1 PLC	±-	APVD	-
MATERIAL		2 PLC	±-	PRODUCT SPEC	
		3 PLC	±-	108-19052	
FINISH		4 PLC	±-	APPLICATION SPEC	
		ANGLES	±-	-	
-		FINISH	-	WEIGHT	
-		-		CUSTOMER DRAWING	



NAME				RESTRICTED TO	
CONNECTOR, FEMALE-ON-BOARD TOP-ENTRY, SMD, WITH LATCHES, Micro-MaTch					
SIZE	CAGE CODE	DRAWING NO	-		
A3	00779	C=338069	-		
SCALE		SHEET		REV	
5:1		2 OF 3		H1	

THIS DRAWING IS UNPUBLISHED. RELEASED FOR PUBLICATION

© COPYRIGHT - BY ALL RIGHTS RESERVED.

LOC	DIST	REVISIONS					
H	-	P	LTR	DESCRIPTION	DATE	DWN	APVD
		-		SEE SHEET 1	-	-	-

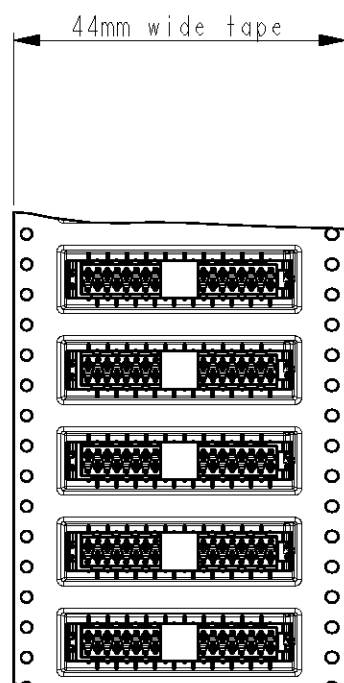

9-338069-0
20 POSITIONS
2-338069-0

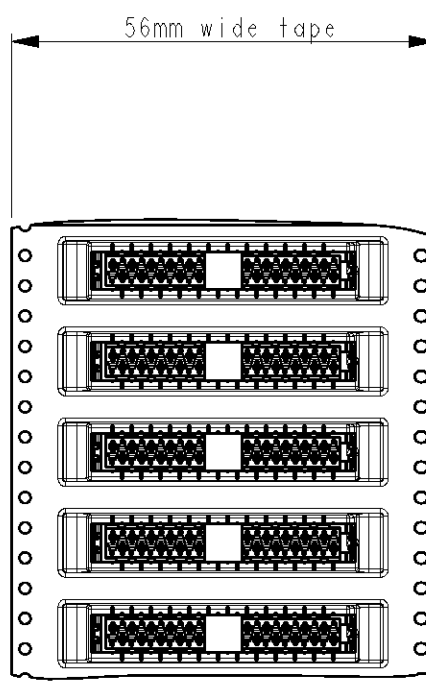

9-338069-4
24 POSITIONS
2-338069-4

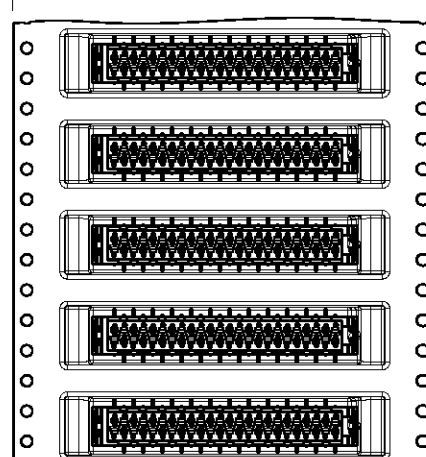
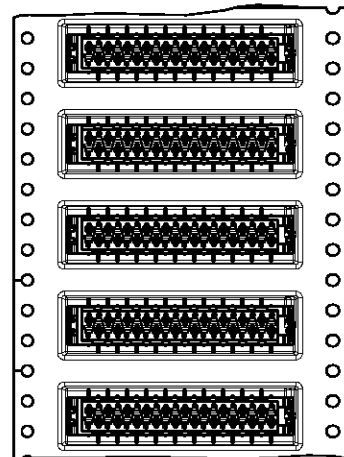

DWN M. Gosselink		IIDECO1					
CHK -		-					
APVD -		-		NAME			
PRODUCT SPEC 108-19052		APPLICATION SPEC -		CONNECTOR, FEMALE-ON-BOARD TOP-ENTRY, SMD, WITH LATCHES, Micro-MaTch			
MATERIAL -		FINISH -		SIZE A3	CAGE CODE 00779	DRAWING NO C-338069	RESTRICTED TO -
DIMENSIONS: mm		TOLERANCES UNLESS OTHERWISE SPECIFIED: 0 PLC ±- 1 PLC ±- 2 PLC ±- 3 PLC ±- 4 PLC ±- ANGLES ±-		SCALE 5:1		SHEET 3 OF 3	
CUSTOMER DRAWING				REV H1			