

SUGGESTED PCB LAYOUT (TOP VIEW)

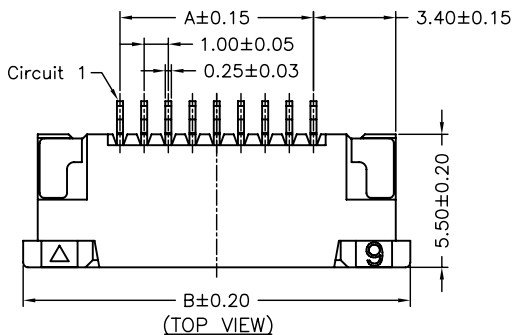

(TOP VIEW)

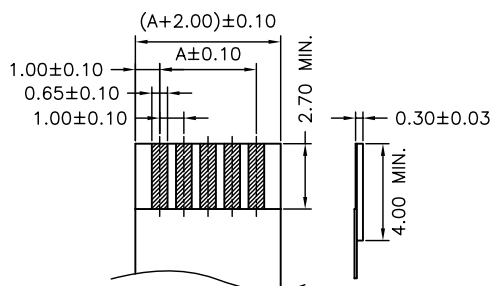
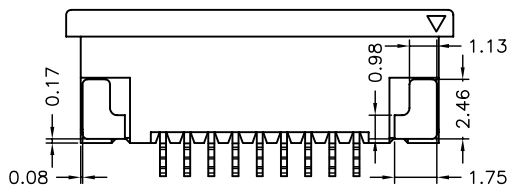
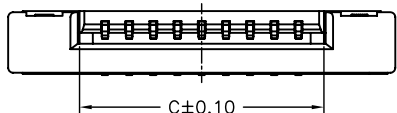

RECOMMENDED FFC/FPC DIMENSION

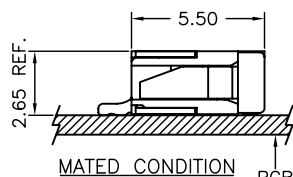
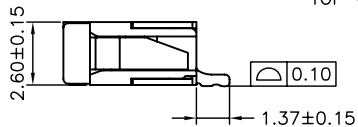
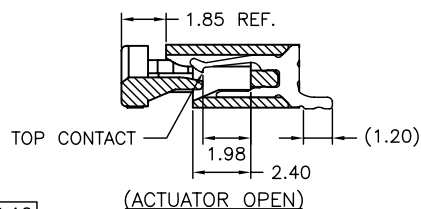

Ordering code

F1003 ① WR-S-XP XXX ② ③ ④ ⑤

- ① Series No.
- ② Connector type: WR=Right angle
- ③ Mounting type: S=SMT without boss
- ④ No. of circuits
- ⑤ Option code:  
 T=Top contact style  
 Contacts/Matte Tin-plated  
 Solder tabs/Matte Tin-plated  
 DT1=Top contact style  
 Contacts/Gold-flash  
 Solder tabs/Gold-flash

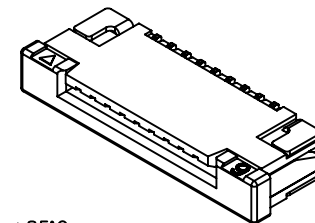

SPECIFICATIONS

Current Rating: 0.5A AC,DC  
 Voltage Rating: 50V AC,DC  
 Temperature Range:  $-40^{\circ}\text{C} \sim +85^{\circ}\text{C}$   
 Contact Resistance:  $30\text{m}\Omega$  Max.  
 Insulation Resistance:  $500\text{M}\Omega$  Min.  
 Withstanding Voltage: 500V AC/minute  
 Contacts: Phosphor Bronze/Matte Tin-plated or Gold-flash  
 Solder Tabs: Brass/Matte Tin-plated or Gold-flash  
 Housing: Nylon 6T,UL94V-0,Natural(Beige)  
 Actuator: Nylon 6T,UL94V-0,Natural(Black)

Circuit No.	Dimensions			Circuit No.	Dimensions		
	A	B	C		A	B	C
04P	3.00	11.00	5.10	20P	19.00	27.00	21.10
05P	4.00	12.00	6.10	21P	20.00	28.00	22.10
06P	5.00	13.00	7.10	22P	21.00	29.00	23.10
07P	6.00	14.00	8.10	23P	22.00	30.00	24.10
08P	7.00	15.00	9.10	24P	23.00	31.00	25.10
09P	8.00	16.00	10.10	25P	24.00	32.00	26.10
10P	9.00	17.00	11.10	26P	25.00	33.00	27.10
11P	10.00	18.00	12.10	27P	26.00	34.00	28.10
12P	11.00	19.00	13.10	28P	27.00	35.00	29.10
13P	12.00	20.00	14.10	29P	28.00	36.00	30.10
14P	13.00	21.00	15.10	30P	29.00	37.00	31.10
15P	14.00	22.00	16.10	31P	30.00	38.00	32.10
16P	15.00	23.00	17.10	32P	31.00	39.00	33.10
17P	16.00	24.00	18.10	33P	32.00	40.00	34.10
18P	17.00	25.00	19.10	34P	33.00	41.00	35.10
19P	18.00	26.00	20.10				

					JOINT TECH ELECTRONIC IND. CO., LTD.		TITLE: 1.00mm PITCH FFC/FPC CONNECTOR, 90° SMT TYPE, ZIF, TOP CONTACT STYLE	
			UNIT	SCALE	SHEET	DRAW NO. : F1003WR-S-XPT		
B0	EN0911030531	2009.11.03	mm		1 of 2	REV. BO		
A5	REVISE	2009.06.16	DRAWN BY		APPROVED BY			
A4	REVISE	2009.06.09	李勤		董正一			
A3	REVISE	2009.04.30	2006.03.09		2006.03.09			
A2	REVISE	2006.12.07	GENERAL TOLERANCE					
A1	REVISE	2006.04.26	X.X±0.25	ANGLE±				
A0	NEW RELEASE	2006.03.09	X.XX±0.15					
REV.	DESCRIPTION	DATE	X.XXX±0.05					

04~07 Contacts

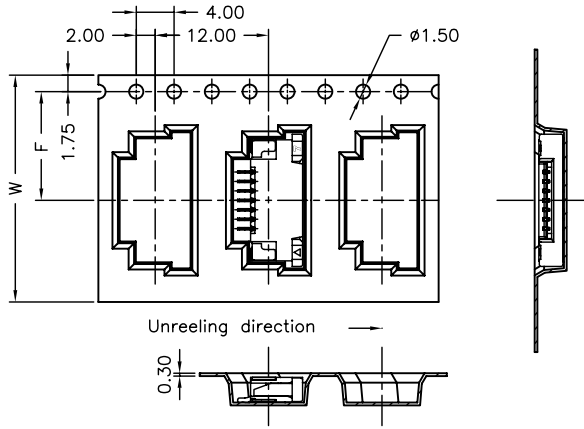

08~34 Contacts

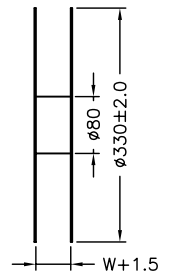
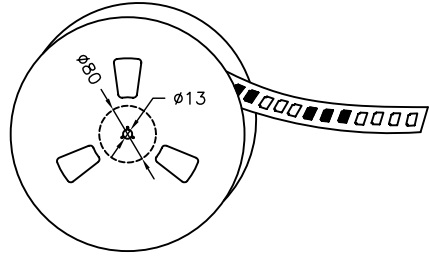
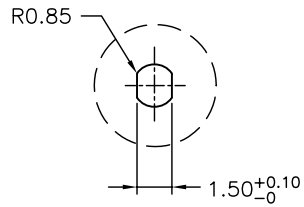
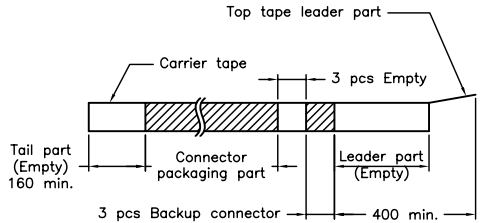
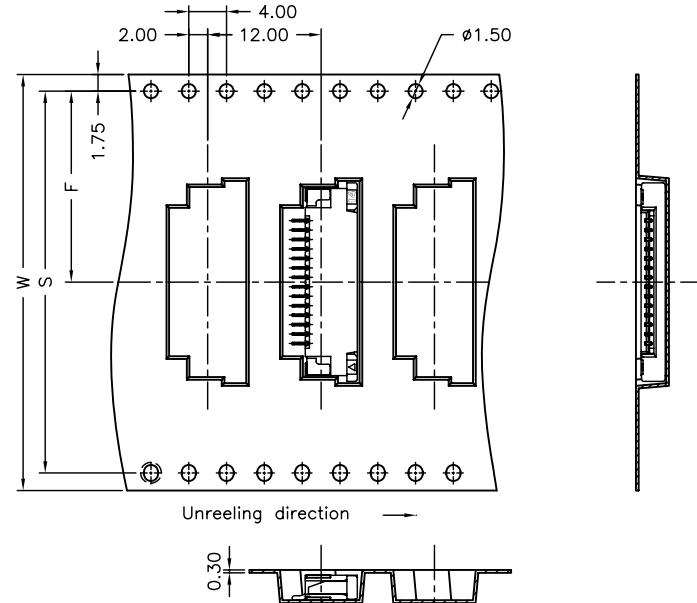

Number of Contacts	W±0.3	F±0.1	S±0.1	Q'ty/Reel	Number of Contacts	W±0.3	F±0.1	S±0.1	Q'ty/Reel
04P	24	11.50	/	1,500	20P	44	20.20	40.40	1,500
05P	24	11.50		1,500	21P	44	20.20	40.40	1,500
06P	24	11.50		1,500	22P	44	20.20	40.40	1,500
07P	24	11.50		1,500	23P	44	20.20	40.40	1,500
08P	32	14.20	28.40	1,500	24P	44	20.20	40.40	1,500
09P	32	14.20	28.40	1,500	25P	44	20.20	40.40	1,500
10P	32	14.20	28.40	1,500	26P	56	26.20	52.40	1,500
11P	32	14.20	28.40	1,500	27P	56	26.20	52.40	1,500
12P	32	14.20	28.40	1,500	28P	56	26.20	52.40	1,500
13P	44	20.20	40.40	1,500	29P	56	26.20	52.40	1,500
14P	44	20.20	40.40	1,500	30P	56	26.20	52.40	1,500
15P	44	20.20	40.40	1,500	31P	56	26.20	52.40	1,500
16P	44	20.20	40.40	1,500	32P	56	26.20	52.40	1,500
17P	44	20.20	40.40	1,500	33P	56	26.20	52.40	1,500
18P	44	20.20	40.40	1,500	34P	56	26.20	52.40	1,500
19P	44	20.20	40.40	1,500					

NOTE:

Material: Transparent Anti-static Polystyrene.

			燦達電子工業股份有限公司 JOINT TECH ELECTRONIC IND. CO., LTD.		
		UNIT	SCALE	SHEET	
		mm		2 of 2	
		DRAWN BY		APPROVED BY	
		李勤		董正一	
A3	EN0911030531	2009.11.03	2006.03.09	2006.03.09	
A2	REVISE	2006.12.07	GENERAL TOLERANCE		
A1	REVISE	2006.04.26	X. X±0.25	ANGLE±	
A0	NEW RELEASE	2006.03.09	X. XX±0.15		
REV.	DESCRIPTION	DATE	X. XXX±0.05		
				DRAW NO. : F1003WR-S-XPT	
				REV. A3	

TITLE:  
 1.00mm PITCH FFC/FPC  
 CONNECTOR, 90° SMT TYPE,  
 ZIF, TOP CONTACT STYLE,  
 TAPING SPEC.