

reliable
economical

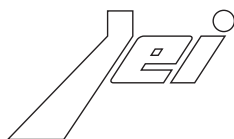

- inserts in light technopolymer
 - tinned precision contacts
- enclosures in die-cast aluminum alloy
- vertical safety closing levers in zinc-plated steel



- polarity: 6, 10, 16, 24 + ⊕
- rated current: 16A
- rated voltage: 500V
- EN 61984 (2001-11): 500V/6kV/3 - 400V/690V/6kV/2
- screw terminal for conductors, section 0.5÷2.5 mm² - AWG 20÷14, with conductor protection plate
- different sized steel screws
- contact surface: tinned
- UL V0 approved self-extinguishing thermoplastic material

JCNEF 06 - JCNEM 06

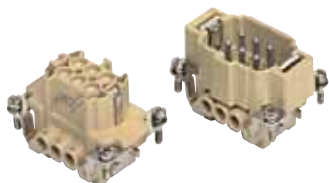

dimensions in mm

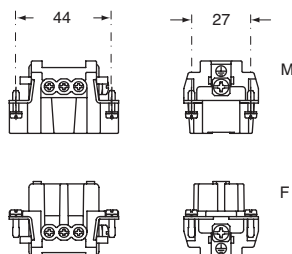

polarity (contact side)

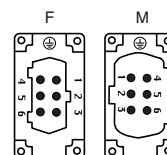

JCNEF 10 - JCNEM 10

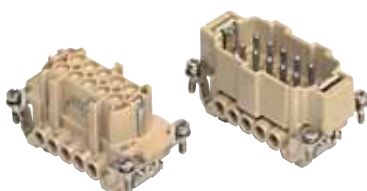

dimensions in mm

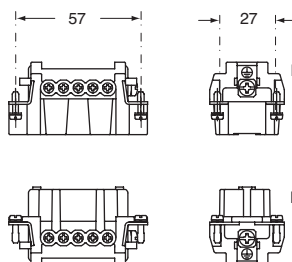

polarity (contact side)

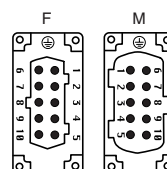

JCNEF 16 - JCNEM 16

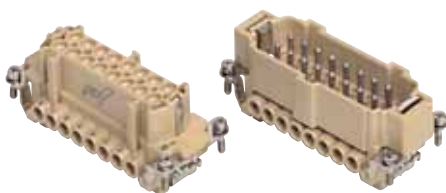

dimensions in mm

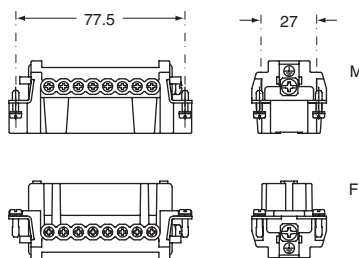

polarity (contact side)

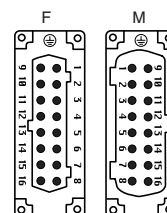

JCNEF 24 - JCNEM 24

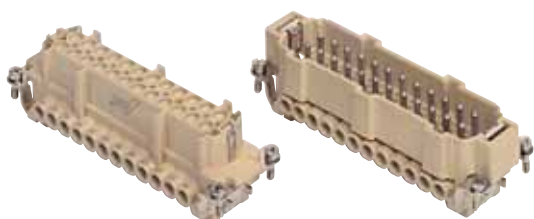

dimensions in mm

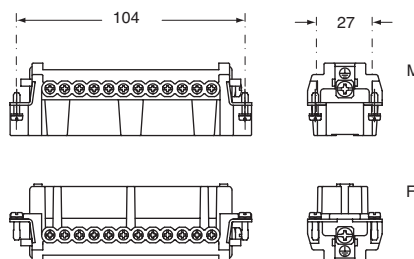

polarity (contact side)

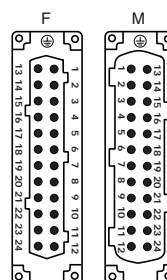

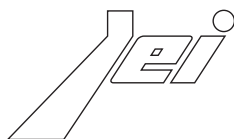

drawing	ILME part No.	description	package
---------	---------------	-------------	---------

JCNE inserts - 16A - 500V/6kV/3

female inserts

JCNEF 06	06 poles + ⊕	for enclosure size 44.27	10/100
JCNEF 10	10 poles + ⊕	for enclosure size 57.27	5/80
JCNEF 16	16 poles + ⊕	for enclosure size 77.27	5/80
JCNEF 24	24 poles + ⊕	for enclosure size 104.27	5/80

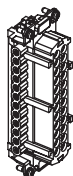

male inserts

JCNEM 06	06 poles + ⊕	for enclosure size 44.27	10/100
JCNEM 10	10 poles + ⊕	for enclosure size 57.27	5/80
JCNEM 16	16 poles + ⊕	for enclosure size 77.27	5/80
JCNEM 24	24 poles + ⊕	for enclosure size 104.27	5/80

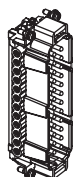

Enclosure identification

Matching connector inserts with the correct enclosures can be complicated.

To simplify we have used the definition of “size” in addition to the product’s normal identification code.



From the figure to the left and the table below, this new variable refers to the fixing distance between screw centres which, is the same for inserts and enclosures, and clear.

All the pages illustrating inserts and enclosures bear the relevant identification references.

The table below sets out all the enclosure “sizes” and the dimension of the insert fixing slots.

enclosure “size” identification	slot for inserts with fixing distance x - y
“44.27”	44 x 27 mm
“57.27”	57 x 27 mm
“77.27”	77.5 x 27 mm
“104.27”	104 x 27 mm

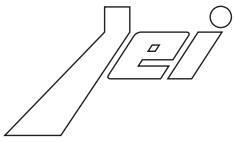

- enclosures in aluminum alloy
- painted with grey RAL 7040
- enclosures JCVI / JCVP with two levers in zinc-plated steel
- IP65 degree of protection in accordance with EN 60529
- for inserts size 57.27, 77.27, 104.27

JCVI

dimensions in mm

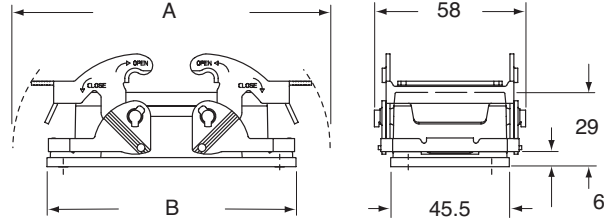

panel cut-out for bulkhead housings in mm

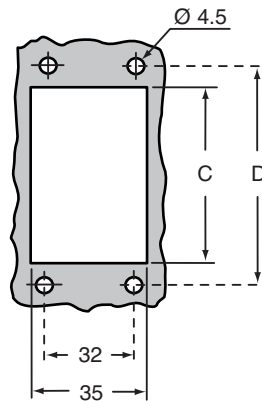

type	A	B	C	D
JCVI 10	122	95.5	65	83
JCVI 16	142.5	115.5	86	103
JCVI 24	169	142.5	112	130

JCVP

dimensions in mm

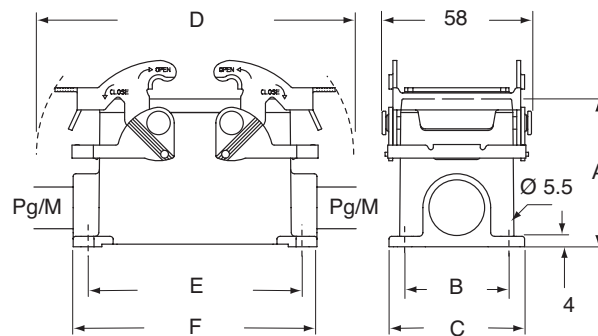

type	A	B	C	D	E	F
JCVP 10	57	40	52	122	82	93.5
JCVP 16	63	45	57	142.5	105	117
JCVP 24	63	45	57	169	132	144

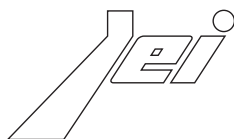

bulkhead mounting housings with levers

may be combined with: hoods without gasket, with pegs for two levers
closing covers with pegs for two levers

		CD	CT CTS (10A)	CDD	CQE	CN-CNE CCE CSE	CT CTSE (16A)	CMSE CMCE	CP	CX	MIXO	JCNE	package
JCVI 10	standard version size 57.27	--	--	42	18	10	10	3+2	--	8/24	3*	10	5/40
JCVI 16	size 77.27	40	40	72	32	16	16	6+2	6	A	4*	16	5/40
JCVI 24	size 104.27	64	64	108	46	24	24	10+2	--	4/8	6*	24	5/40

* = number of modules that may be mounted via frames
A = CX 4/0, CX 4/2, CX 6/36, CX 12/2

Pg threading - wall-mounting housings with levers

may be combined with: hoods without gasket, with pegs for two levers
closing covers with pegs for two levers

		CD	CDD	CQE	CN-CNE CCE CSE	CMSE CMCE	CP	CX	MIXO	JCNE	package
JCVP 10	normal standard version size 57.27 - Pg 16	--	42	18	10	3+2	--	8/24	3*	10	5/20
JCVP 16	size 77.27 - Pg 21	40	72	32	16	6+2	6	A	4*	16	5/20
JCVP 24	size 104.27 - Pg 21	64	108	46	24	10+2	--	4/8	6*	24	5/20

* = number of modules that may be mounted via frames
A = CX 4/0, CX 4/2, CX 6/36, CX 12/2

- enclosures with metric threading upon request
- high enclosures upon request
- characteristics of other inserts, not belonging to the Jei series, in the CN catalogue

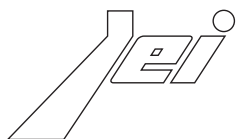

- enclosures in aluminum alloy
- painted with grey RAL 7040
- JCHO / JCHV enclosures with 4 pegs for 2-lever enclosures
- IP65 degree of protection in accordance with EN 60529
- for inserts size 57.27, 77.27, 104.27

JCHO

dimensions in mm

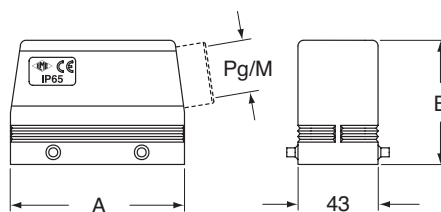

type	A	B
JCHO 10	73	52
JCHO 16	93.5	63
JCHO 24	120	63

JCHV

dimensions in mm

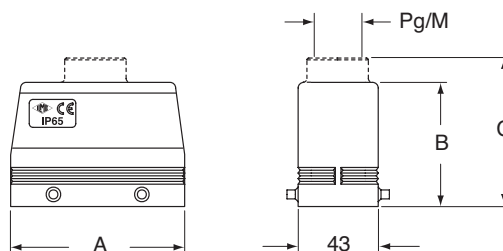

type	A	B	C
JCHV 10	73	45	58
JCHV 16	93.5	45	58
JCHV 24	120	55	69.5

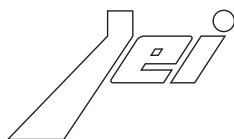

Pg threading - side entry hoods - with pegs

may be combined with: bulkhead or wall-mounting housings with two levers and gasket
hoods with two levers and gasket
closing covers with two levers and gasket

		CD	CDD	CQE	CN-CNE CCE	CMSE CMCE CSE	CP	CX	MIXO	JCNE	package
JCHO 10	normal standard version size 57.27 - Pg 16	--	42	18	10	3+2	--	8/24	3*	10	100
JCHO 16	size 77.27 - Pg 21	40	72	32	16	6+2	6	Ⓐ	4*	16	100
JCHO 24	size 104.27 - Pg 21	64	108	46	24	10+2	--	4/8	6*	24	80

* = number of modules that may be mounted via frames
Ⓐ = CX 4/0, CX 4/2, CX 6/36, CX 12/2

- enclosures with metric threading upon request
- high enclosures upon request
- characteristics of other inserts, not belonging to the Jei series, in the CN catalogue

Pg threading - top entry hoods - with pegs

may be combined with: bulkhead or wall-mounting housings with two levers and gasket
hoods with two levers and gasket
closing covers with two levers and gasket

		CD	CDD	CQE	CN-CNE CCE	CMSE CMCE CSE	CP	CX	MIXO	JCNE	package
JCHV 10	normal standard version size 57.27 - Pg 16	--	42	18	10	3+2	--	8/24	3*	10	100
JCHV 16	size 77.27 - Pg 21	40	72	32	16	6+2	6	Ⓐ	4*	16	80
JCHV 24	size 104.27 - Pg 21	64	108	46	24	10+2	--	4/8	6*	24	80

* = number of modules that may be mounted via frames
Ⓐ = CX 4/0, CX 4/2, CX 6/36, CX 12/2

- enclosures with metric threading upon request
- high enclosures upon request
- characteristics of other inserts, not belonging to the Jei series, in the CN catalogue

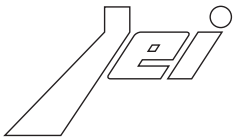

- enclosures in aluminum alloy
- painted with grey RAL 7040
- enclosures JCVI L / JCVP L with one lever in zinc-plated steel
- IP65 degree of protection in accordance with EN 60529
- for inserts size 44.27, 57.27, 77.27, 104.27

JCVI L

dimensions in mm

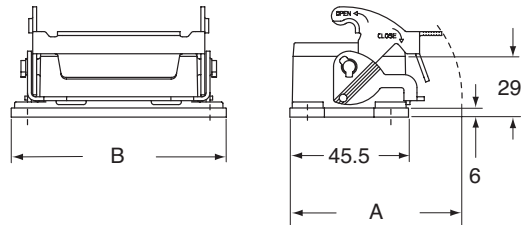

panel cut-out for bulkhead housings in mm

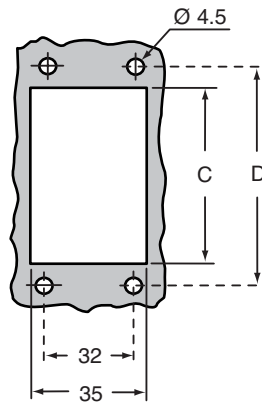

type	A	B	C	D
JCVI 06 L	66	82.5	52	70
JCVI 10 L	70	95.5	65	83
JCVI 16 L	70	115.5	86	103
JCVI 24 L	70	142.5	112	130

JCVP L

dimensions in mm

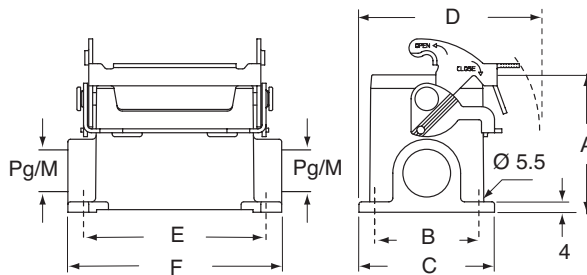

type	A	B	C	D	E	F
JCVP 06 L	53	40	52	70	70	82
JCVP 10 L	57	40	52	73	82	93.5
JCVP 16 L	63	45	57	75.5	105	117
JCVP 24 L	63	45	57	75.5	132	144

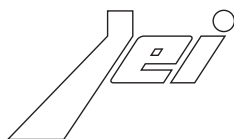

bulkhead mounting housings with single lever

may be combined with: hoods with pegs for one lever
closing covers with pegs for one lever

		CD	CT CTS (10A)	CDD	CQE	CN-CNE CCE CSE	CT CTSE (16A)	CMSE CMCE	CP	CX	MIXO	JCNE	package
JCVI 06 L	standard version size 44.27	--	--	24	10	6	6	--	--	--	2*	6	5/40
JCVI 10 L	size 57.27	--	--	42	18	10	10	3+2	--	8/24	3*	10	5/20
JCVI 16 L	size 77.27	40	40	72	32	16	16	6+2	6	A	4*	16	5/20
JCVI 24 L	size 104.27	64	64	108	46	24	24	10+2	--	4/8	6*	24	5/20

* = number of modules that may be mounted via frames
A = CX 4/0, CX 4/2, CX 6/36, CX 12/2

Pg threading - wall-mounting housings with single lever

may be combined with: hoods with pegs for one lever
closing covers with pegs for one lever

		CD	CDD	CQE	CN-CNE CCE CSE	CMSE CMCE	CP	CX	MIXO	JCNE	package
JCVP 06 L	standard version size 44.27 - Pg 16	--	24	10	6	--	--	--	2*	6	5/20
JCVP 10 L	size 57.27 - Pg 16	--	42	18	10	3+2	--	8/24	3*	10	5/10
JCVP 16 L	size 77.27 - Pg 21	40	72	32	16	6+2	6	A	4*	16	5/10
JCVP 24 L	size 104.27 - Pg 21	64	108	46	24	10+2	--	4/8	6*	24	5/10

* = number of modules that may be mounted via frames
A = CX 4/0, CX 4/2, CX 6/36, CX 12/2

- enclosures with metric threading upon request
- high enclosures upon request
- characteristics of other inserts, not belonging to the Jei series, in the CN catalogue

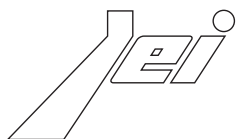

- enclosures in aluminum alloy
- painted with grey RAL 7040
- JCVI LP / JCVP LP enclosures with one lever in zinc-plated steel and a cover in self-extinguishing thermoplastic material
- IP65 degree of protection in accordance with EN 60529
- for inserts size 44.27, 57.27, 77.27, 104.27

JCVI LP

dimensions in mm

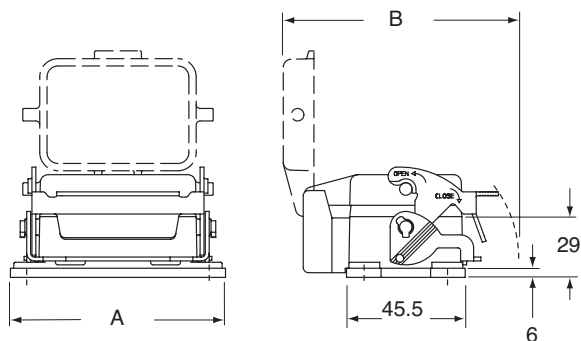

panel cut-out for bulkhead housings in mm

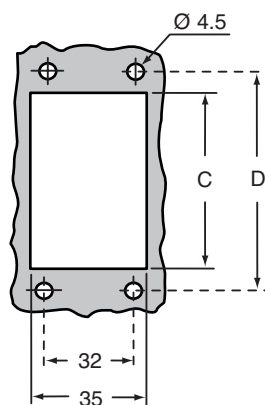

type	A	B	C	D
JCVI 06 LP	82.5	89	52	70
JCVI 10 LP	95.5	94	65	83
JCVI 16 LP	115.5	94	86	103
JCVI 24 LP	142.5	94	112	130

JCVP LP

dimensions in mm

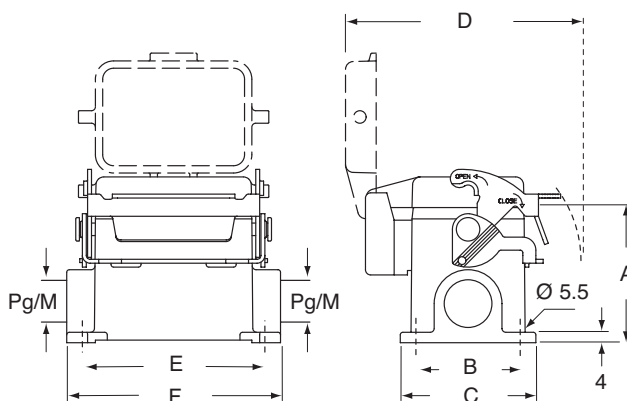

type	A	B	C	D	E	F
JCVP 06 LP	53	40	52	91	70	82
JCVP 10 LP	57	40	52	94	82	93.5
JCVP 16 LP	63	45	57	94	105	117
JCVP 24 LP	63	45	57	94	132	144

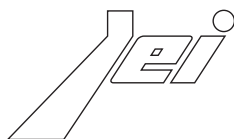

bulkhead mounting housings with lever and thermoplastic cover

may be combined with: hoods with pegs for one lever

	CD	CT CTS (10A)	CDD	CQE	CN-CNE CCE CSE	CT CTSE (16A)	CMSE CMCE	CP	CX	MIXO	JCNE	package
standard version												
JCVI 06 LP <i>size 44.27</i>	--	--	24	10	6	6	--	--	--	2*	6	5/20
JCVI 10 LP <i>size 57.27</i>	--	--	42	18	10	10	3+2	--	8/24	3*	10	5/20
JCVI 16 LP <i>size 77.27</i>	40	40	72	32	16	16	6+2	6	Ⓐ	4*	16	5/20
JCVI 24 LP <i>size 104.27</i>	64	64	108	46	24	24	10+2	--	4/8	6*	24	5/20

* = number of modules that may be mounted via frames

Ⓐ = CX 4/0, CX 4/2, CX 6/36, CX 12/2

Pg threading - wall-mounting housings with lever and thermoplastic cover

may be combined with: hoods with pegs for one lever

	CD	CDD	CQE	CN-CNE CCE	CMSE CMCE CSE	CP	CX	MIXO	JCNE	package
standard version										
JCVP 06 LP <i>size 44.27 - Pg 16</i>	--	24	10	6	--	--	--	2*	6	5/10
JCVP 10 LP <i>size 57.27 - Pg 16</i>	--	42	18	10	3+2	--	8/24	3*	10	5/10
JCVP 16 LP <i>size 77.27 - Pg 21</i>	40	72	32	16	6+2	6	Ⓐ	4*	16	5/10
JCVP 24 LP <i>size 104.27 - Pg 21</i>	64	108	46	24	10+2	--	4/8	6*	24	5/10

* = number of modules that may be mounted via frames

Ⓐ = CX 4/0, CX 4/2, CX 6/36, CX 12/2

- enclosures with metric threading upon request
- high enclosures upon request
- characteristics of other inserts, not belonging to the Jei series, in the CN catalogue

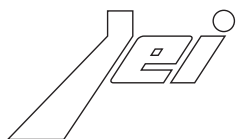

- enclosures in aluminum alloy
- painted with grey RAL 7040
- JCHO L / JCHV L enclosures with 2 pegs for 1-lever enclosures
- IP65 degree of protection in accordance with EN 60529
- for inserts size 44.27, 57.27, 77.27 104.27

JCHO L

dimensions in mm

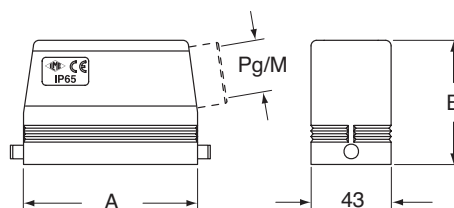

type	A	B
JCHO 06 L16	60	47
JCHO 10 L	73	52
JCHO 16 L	93.5	63
JCHO 24 L	120	63

JCHV L

dimensions in mm

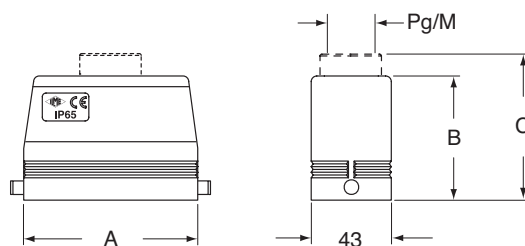

type	A	B	C
JCHV 06 L16	60	40	53
JCHV 10 L	73	45	58
JCHV 16 L	93.5	45	58
JCHV 24 L	120	55	69.5

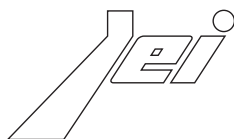

Pg threading - side entry hoods - with pegs

may be combined with: bulkhead or wall-mounting housings with lever
hoods with lever
closing covers with lever

		CD	CDD	CQE	CN-CNE CCE	CMSE CMCE CSE	CP	CX	MIXO	JCNE	package
normal standard version											
JCHO 06 L16	size 44.27 - Pg 16	--	24	10	6	--	--	--	2*	6	100
JCHO 10 L	size 57.27 - Pg 16	--	42	18	10	3+2	--	8/24	3*	10	100
JCHO 16 L	size 77.27 - Pg 21	40	72	32	16	6+2	6	A	4*	16	100
JCHO 24 L	size 104.27 - Pg 21	64	108	46	24	10+2	--	4/8	6*	24	80

* = number of modules that may be mounted via frames
A = CX 4/0, CX 4/2, CX 6/36, CX 12/2

- enclosures with metric threading upon request
- high enclosures upon request
- characteristics of other inserts, not belonging to the Jei series, in the CN catalogue

Pg threading - top entry hoods - with pegs

may be combined with: bulkhead or wall-mounting housings with lever
hoods with lever
closing covers with lever

		CD	CDD	CQE	CN-CNE CCE	CMSE CMCE CSE	CP	CX	MIXO	JCNE	package
normal standard version											
JCHV 06 L16	size 44.27 - Pg 16	--	24	10	6	--	--	--	2*	6	100
JCHV 10 L	size 57.27 - Pg 16	--	42	18	10	3+2	--	8/24	3*	10	100
JCHV 16 L	size 77.27 - Pg 21	40	72	32	16	6+2	6	A	4*	16	80
JCHV 24 L	size 104.27 - Pg 21	64	108	46	24	10+2	--	4/8	6*	24	80

* = number of modules that may be mounted via frames
A = CX 4/0, CX 4/2, CX 6/36, CX 12/2

- enclosures with metric threading upon request
- high enclosures upon request
- characteristics of other inserts, not belonging to the Jei series, in the CN catalogue

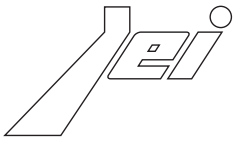

drawing	ILME part No.	description	package
---------	---------------	-------------	---------

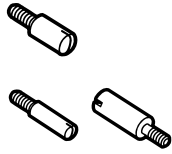

code pins and guides			
single pin - in steel - for 6 variants			
CR 20 D		for connector inserts	50
double pin - in steel - for 16 variants			
CRM D		male - for connector inserts	50
CRF D		female - for connector inserts	50

selection using single code pins

application with single insert

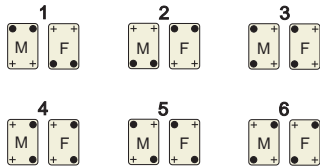

application with double inserts

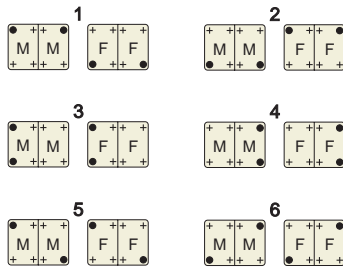

● code pin (CR 20 D)
 + normal fixing screw
 M = male insert
 F = female insert

selection using double code pins

application with single insert

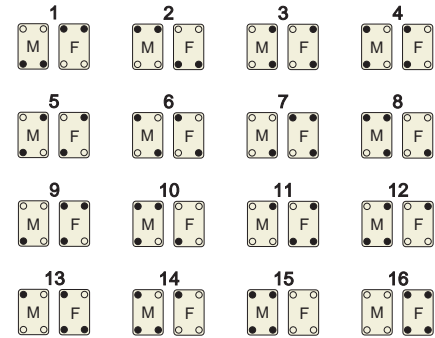

application with double inserts

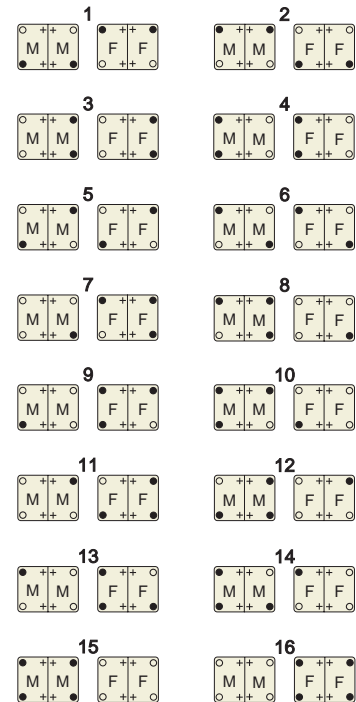

● female code pin (CRF D)
 ○ male code pin (CRM D)
 + normal fixing screw
 M = male insert
 F = female insert