

Diritti riservati All rights reserved

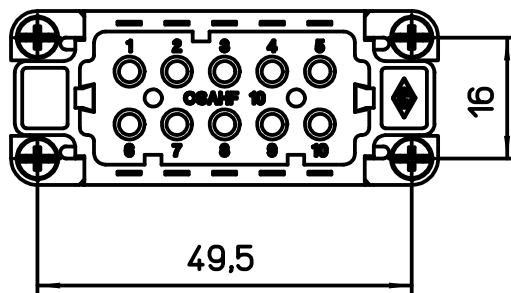
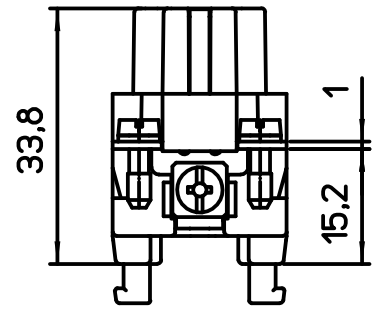
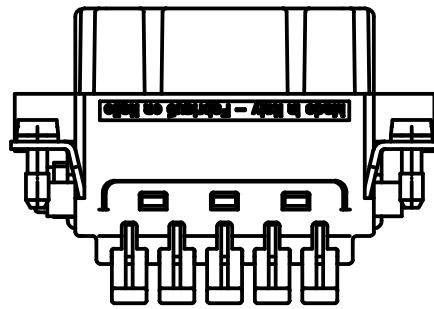
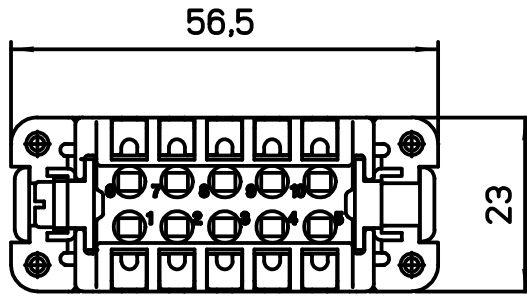
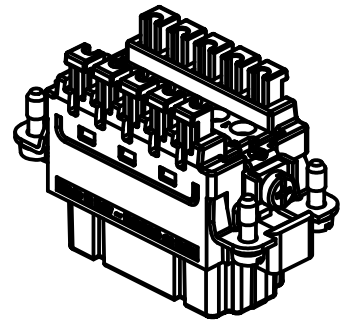

dimensions in mm	CSAHF 10	Scale	
Date 03/11/15	SQUICH female insert, spring, 10P 16A 250V	1:1	
Sign. T.Tedeschi			