

5

4

3

2

1

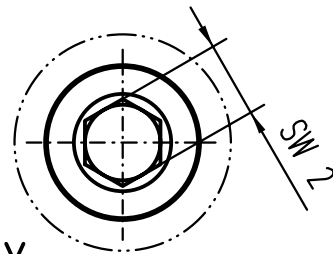
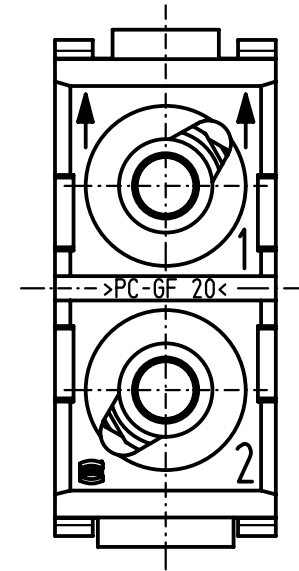
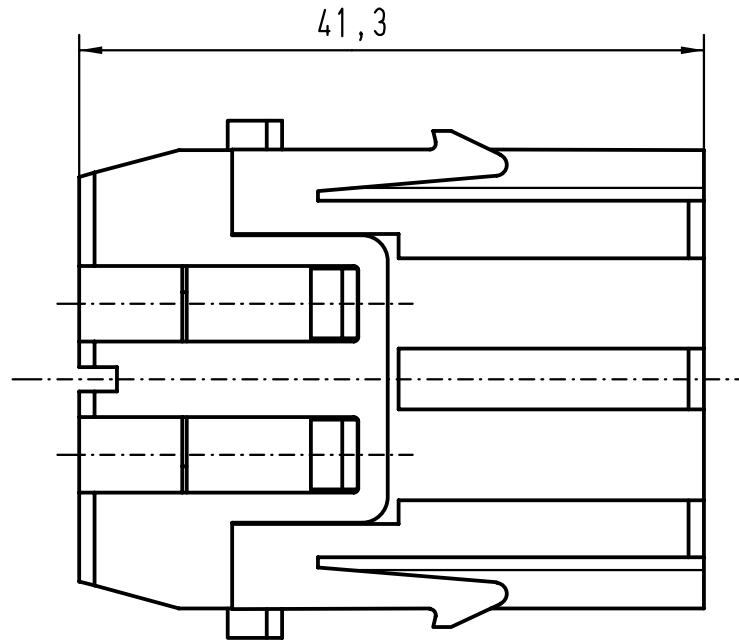
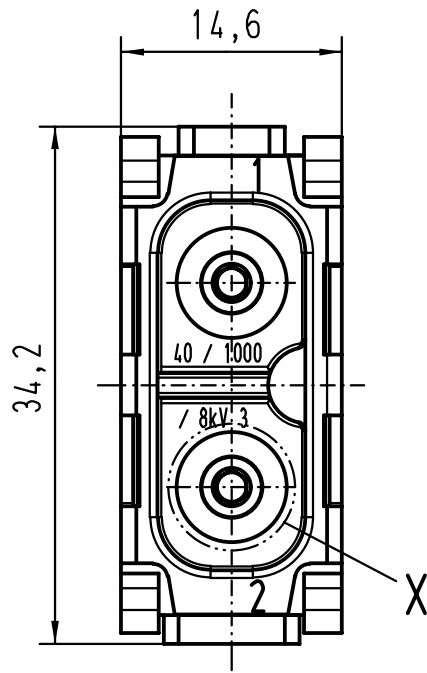



X
5:1

für Litze 2,5 ... 10mm² feindrähtig
(feinstdrähtig 2,5 ... 6mm²)

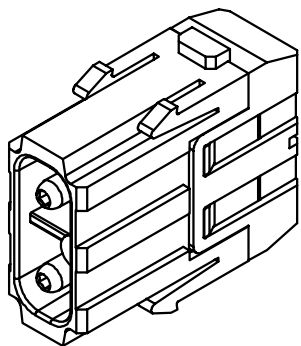
for stranded wire 2,5 ... 10mm² fine wire
(superfine wire 2,5 ... 6mm²)



| | | | | | | | | |
|---|----------|------|-------------------|----------|-------|---|---|-------------|
|  All Dimensions in mm Original Size DIN A 4 | | | Techn. Character. | | | Nicht tolerierte Masse/ Free size tolerances | | |
| | | | | Dat. | Name | Massstab/ Scale 2:1 5:1 | Han-Axialschraub-Modul/ Han axial screw-module Stifteinsatz (M) / male insert (M) | |
| | | | Detail. | 16.05.97 | ML | | | |
| | | | Insp. | | HERB. | | | |
| | | | Stand. | | | | | |
| 25600 | 29.03.99 | KR | HARTING KGaA | | |  | TB 09 14 002 2601 | |
| 22422 | 29.10.97 | ML | D-32339 ESPELKAMP | | | | | |
| Mod. | Dat. | Name | | | | | | |
| | | | | | | | Sub. | Blatt/ page |

D

C

B

A