

CONFIGURATION	PART NUMBER
Male Plug, 32 Pin, 20 Awg, Shell 18	RTOW61832PNH

DIMENSIONS

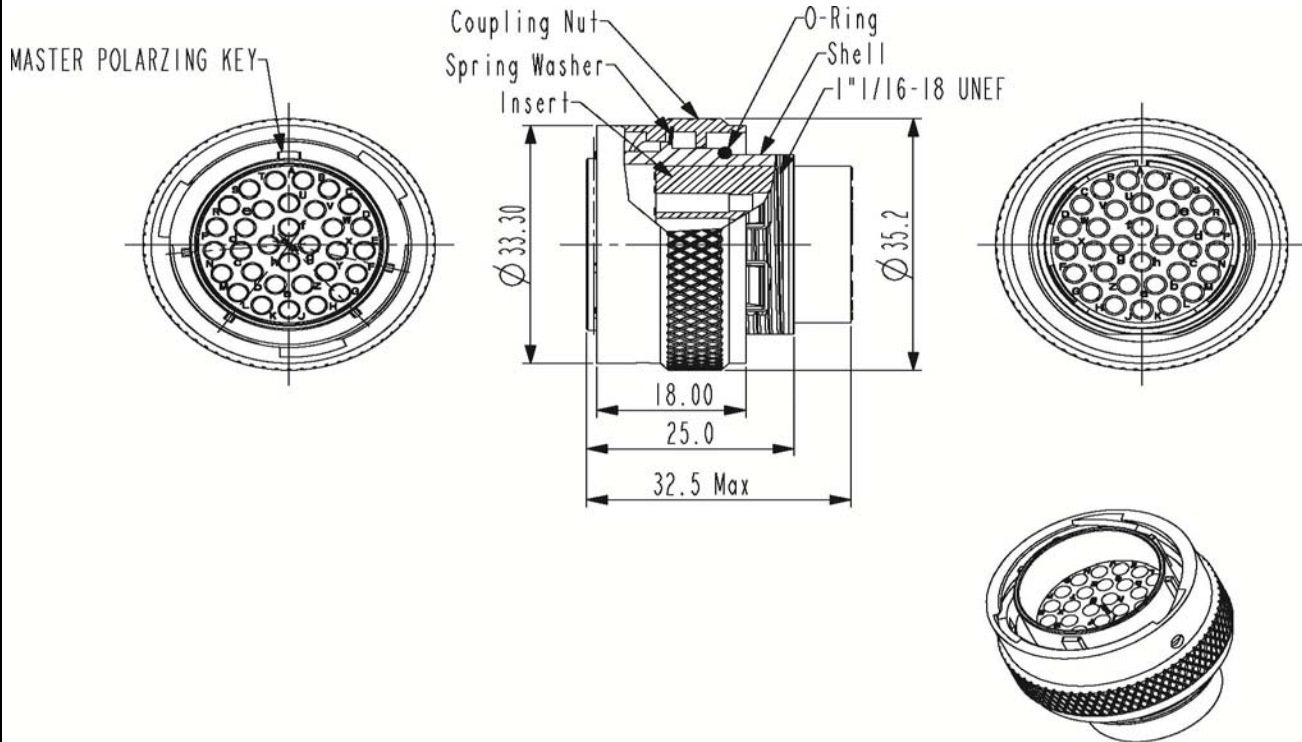

TECHNICAL DATA

TEMPERATURE RANGE:	-40°C to + 105°C
PROTECTION:	IP67 in mated condition and in combination with sealed backshell
VOLTAGE RATING:	150V
HOUSING BODY:	Zinc Alloy, Nickel Plated
COUPLING NUT:	Aluminum, Nickel Plated
INSERT:	Glass-filled Thermoplastic UL94-V0
SEAL:	-
CURRENT:	5A with Stamped and Formed Contact / 7.5A with Machined Contact
CONTACT SIZE:	20Awg
APPROVALS:	UL ECBT2