

LOC J	DIST —	REVISIONS 変更			
P	LTR	DESCRIPTION	DATE	DWN	APVD
	A	RELEASED	19SEP06	TS	KB

SEE CUSTOMER DRAWING 9-1437287-8



RELEASED FOR PUBLICATION

ALL RIGHTS RESERVED.

BY TYCO ELECTRONICS CORPORATION.

THIS DRAWING IS UNPUBLISHED.

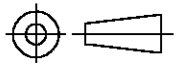
© COPYRIGHT

DIMENSIONS: 単位: 特 mm TOLERANCES UNLESS OTHERWISE SPECIFIED: 一般公差 0 PLC ± - 1 PLC ± - 2 PLC ± - 3 PLC ± - 4 PLC ± - ANGLES ± - 	DWN T.SHINOHARA 19SEP06	MATERIAL 材料 —	FINISH 仕上 —
	CHK K.BETSUI 19SEP06	 Tyco Electronics AMP K.K. Kawasaki, Japan	
	APVD K.BETSUI 19SEP06		
	PRODUCT SPEC 製品規格 —	NAME 名称 SUPER SEAL CONNECTOR CAP HOUSING ASSEMBLY 26POSITION	
	APPLICATION SPEC 取付適用規格 —	SIZE A4	CAGE CODE 00779
WEIGHT —	RESTRICTED TO —		SCALE 尺度 1:1
CUSTOMER DRAWING			SHEET 1 OF 1
			REV A