

4	1	GRID PLATE	PBT 30% GLASS FILLED	BLACK
3	1	HOUSING		BLACK
2	SEE SHEET 2 TABLE 'A'	1.5	CuZn30	NICKEL UNDERCOAT: 1.3µM TO 2.2µM
1	SEE SHEET 2 TABLE 'A'	0.64	CuZn30	MATTE TIN OVERCOAT: 4µM TO 5µM
SL NO.	QTY	DESIGNATION	MATERIAL	FINISH

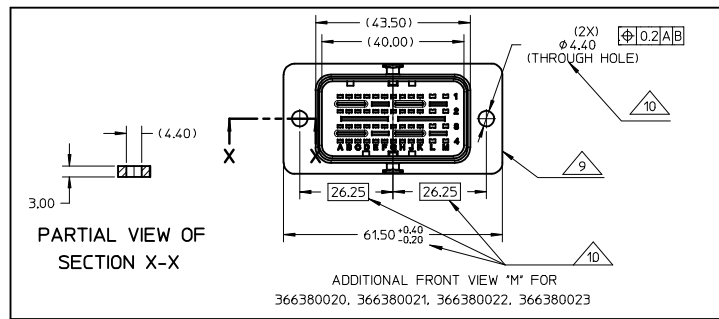

D	6.30	12.90
C	8.50	12.90
B	6.30	10.70
A	12.90	8.50
DIMENSION	366380002	366380003
	366380004	366380005
	366380006	366380007
	366380008	366380009
	366380020	366380021
	366380022	366380023
	(BLACK)	(BROWN)
	MOLEX PN	

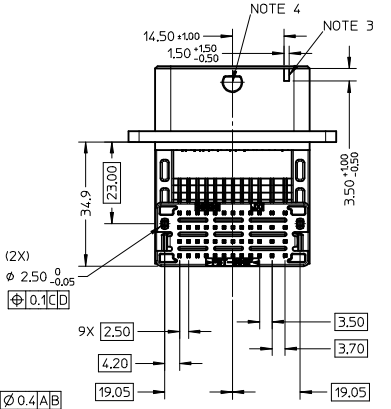
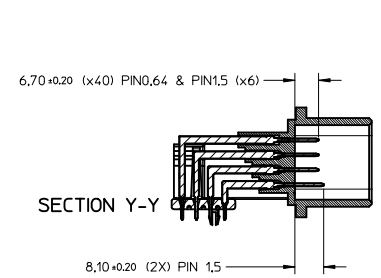
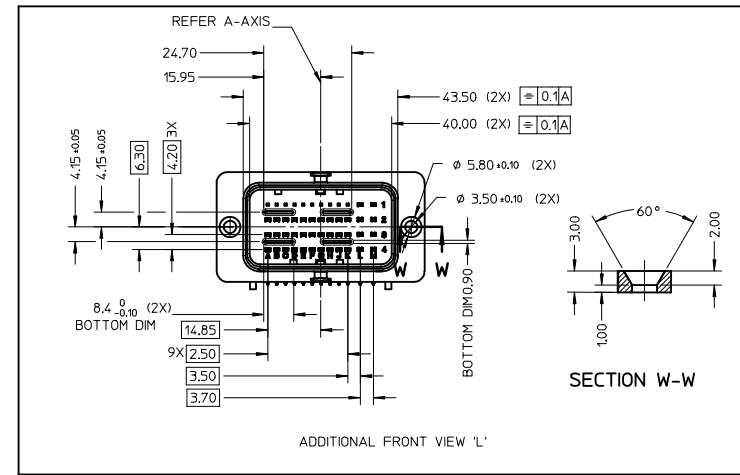
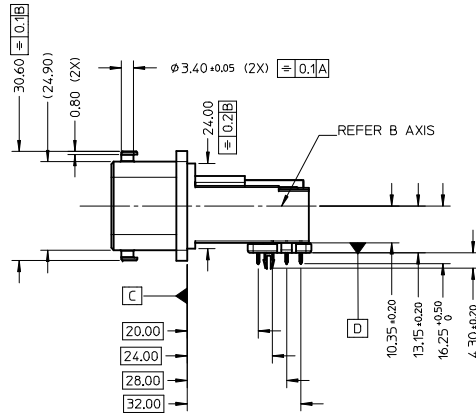
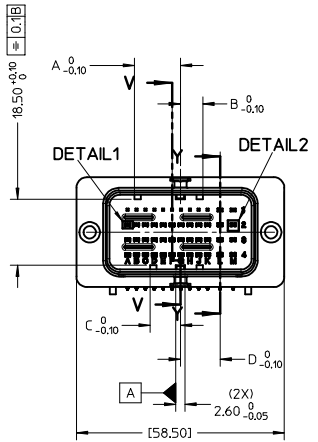
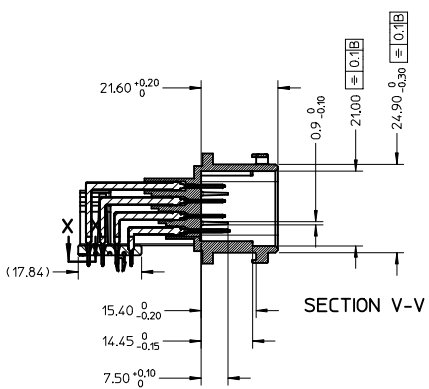
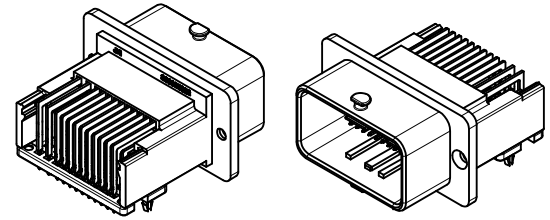
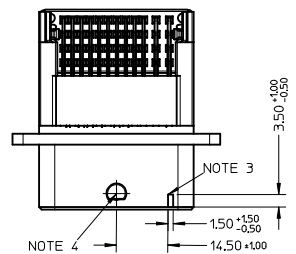
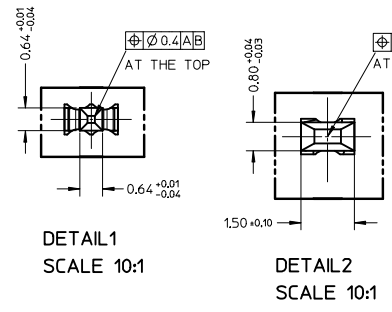

RoHS COMPLIANT

<b>ENTER DESCRIPTION</b> EC NO: I2013-0182 DRWN: BROZ CHKD: APPR: PRASAD 2013/05/24 2013/06/06	<b>QUALITY SYMBOLS</b> ▽=0 ▽=0	<b>GENERAL TOLERANCES (UNLESS SPECIFIED)</b>		<b>DIMENSION STYLE</b> MM ONLY		<b>SCALE</b> 1:1	<b>DESIGN UNITS</b> METRIC	<b>THIRD ANGLE PROJECTION</b>			
		4 PLACES ± --- ± --- 3 PLACES ± --- ± --- 2 PLACES ± 0.1 ± --- 1 PLACE ± 0.2 ± ---		DRAWN BY ROOPESH DATE 08/05/2006		CHECKED BY DINESH DATE 08/05/2006		<b>TITLE</b> CMC HEADER 48/48WAY AND 48/36WAY T3 INTERFACE			
		ANGULAR ± 1°		APPROVED BY DINESH DATE 08/05/2006		<b>MOLEX INCORPORATED</b>			<b>DOCUMENT NO.</b> SD-36638-002		<b>SHEET NO.</b> 1 OF 3
		DRAFT WHERE APPLICABLE MUST REMAIN WITHIN DIMENSIONS		<b>SEE TABLE 'A'</b>		<b>THIS DRAWING CONTAINS INFORMATION THAT IS PROPRIETARY TO MOLEX          INCORPORATED AND SHOULD NOT BE USED WITHOUT WRITTEN PERMISSION</b>					
		<b>REVISION</b> 12									

TABLE 'A'

ASSY CMC HEADER	ASSY CMC 48 WAY 48 CKT (THROUGH HOLE) SEE ADDITIONAL FRONT VIEW "M"	366380020	BLACK	AVAILABLE (SEE VIEW 'A')	1.6	1.5	8	L1 & M1,L2 & M2 L3 & M3,L4 & M4
		366380021	BROWN					A1 TO H1,J1 AND K1 A2 TO H2,J2 AND K2 A3 TO H3,J3 AND K3 A4 TO H4,J4 AND K4
		366380022	BLACK	NOT AVAILABLE (SEE VIEW 'B')	0.8/1.6/2.0	0.64	40	
		366380023	BROWN					
	ASSY CMC 48 WAY 48 CKT (COUNTER SINK) SEE ADDITIONAL FRONT VIEW "L"	366380002	BLACK	AVAILABLE (SEE VIEW 'A')	1.6	1.5	8	L1 & M1,L2 & M2 L3 & M3,L4 & M4
		366380003	BROWN					A1 TO H1,J1 AND K1 A2 TO H2,J2 AND K2 A3 TO H3,J3 AND K3 A4 TO H4,J4 AND K4
		366380004	BLACK	NOT AVAILABLE (SEE VIEW 'B')	0.8/1.6/2.0	0.64	40	
		366380005	BROWN					
	ASSY CMC 48 WAY 36 CKT (COUNTER SINK) SEE ADDITIONAL FRONT VIEW "L"	366380006	BLACK	AVAILABLE (SEE VIEW 'A')	1.6	1.5	6	L2 & M2 L3 & M3,L4 & M4
		366380007	BROWN					A2 TO H2,J2 AND K2 A3 TO H3,J3 AND K3 A4 TO H4,J4 AND K4
		366380008	BLACK	NOT AVAILABLE (SEE VIEW 'B')	0.8/1.6/2.0	0.64	30	
		366380009	BROWN					
DESIGNATION	MOLEX PN	CODING COLOUR	PCB LOCKING ON GRID PLATE	FOR PCB OF THICKNESS	SPEC	QTY	CAVITIES NUMBER	
					PIN			

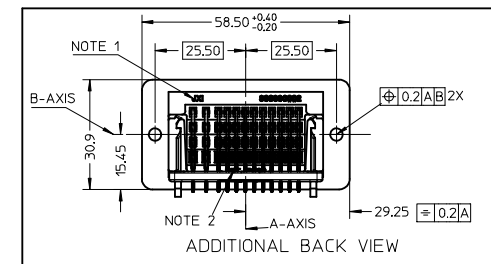
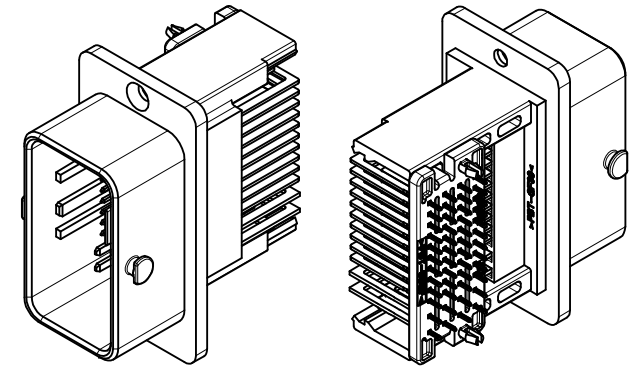

NOTES :

1. AREA FOR JXI AND MOLEX PART NUMBER REPRESENTATION
2. AREA FOR PLASTIC MATERIAL >PBT-30%GF< DESCRIPTION
3. PAINT WITH WHITE COLOR (RoHS COMPLIANT) AT SPECIFIED TWO AREAS
4. PAINT WITH BROWN COLOR (RoHS COMPLIANT) AT SPECIFIED AREA ON BOTH SIDE FOR PN: 366380003,366380005, 366380007,366380009, 366380021, 366380023.
5. PART TO MEET SOLDERABILITY SPEC SMES-152
6. PACKAGING SPECIFICATION:PK-36638-001.
7. PCB SOLDER HOLE SIZE IS DIA 1.1(+0.10/-0.05) FOR THE TERMINALS
8. MANUAL/WAVE SOLDER COMPATIBLE.
9. FOR OTHER DIMENSION(S) REFER REMAINING VIEWS IN THE DRAWING
10. THESE DIMENSIONS IS FOR 366380020, 366380021, 366380022, 366380023 PART NO'S ONLY.
11. 366380020, 366380021, 366380022, 366380023 WILL COMPLY TO VIEW "M". OUT OF WHICH 366380020 AND 366380022 ARE TOOLED AND 366380021, 366380023 ARE NOT TOOLED.

VIEW 'A'

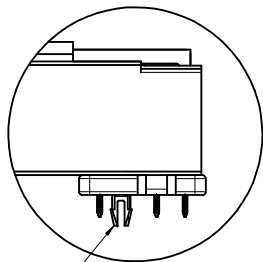

GRID PLATE WITH PCB LOCKING

VIEW 'B'

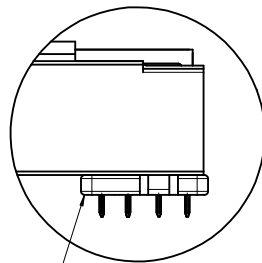

GRID PLATE WITHOUT PCB LOCKING

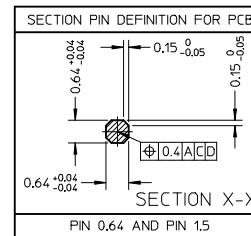

SECTION X-X  
PIN 0.64 AND PIN 15

ENTER DESCRIPTION EC NO: 12013-0182 DRWN:BR02 CHKD: APPR:KPRASAD REV 12	2013/05/24 2013/06/06	QUALITY SYMBOLS ▽=0 ▽=0	GENERAL TOLERANCES (UNLESS SPECIFIED)		DIMENSION STYLE MM ONLY		SCALE 1:1	DESIGN UNITS METRIC	THIRD ANGLE PROJECTION
			m/m	INCH	DRAWN BY R00PESH	DATE 08/05/2006	TITLE CMC HEADER 48/48WAY AND 48/36WAY T3 INTERFACE		
			4 PLACES ± --- ± ---	3 PLACES ± --- ± ---	CHECKED BY DINESH	DATE 08/05/2006	MATERIAL NO. SEE TABLE 'A'		
			2 PLACES ± 0.1 ± ---	1 PLACE ± 0.2 ± ---	APPROVED BY DINESH	DATE 08/05/2006	DOCUMENT NO. SD-36638-002		
DRAFT WHERE APPLICABLE MUST REMAIN WITHIN DIMENSIONS			ANGULAR ± 1°		MOLEX INCORPORATED		SHEET NO. 2 OF 3		
					THIS DRAWING CONTAINS INFORMATION THAT IS PROPRIETARY TO MOLEX INCORPORATED AND SHOULD NOT BE USED WITHOUT WRITTEN PERMISSION				

INTERFACE PCB DEFINITION (SOLDER SIDE)

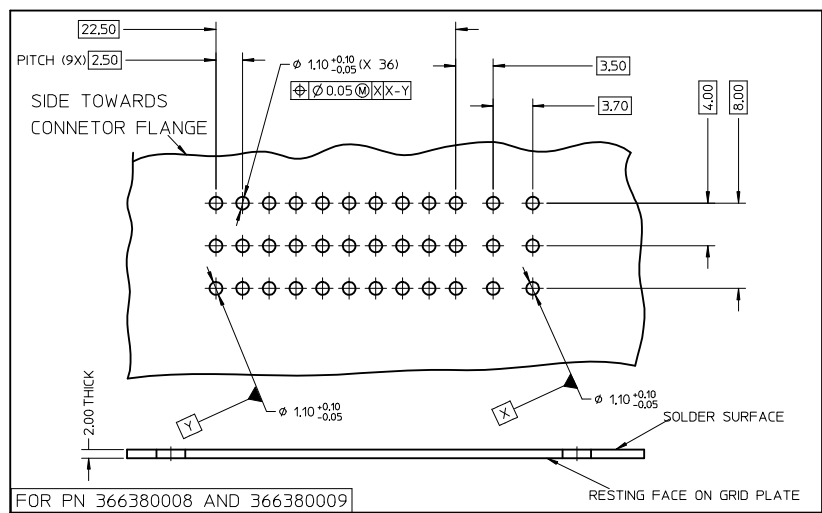
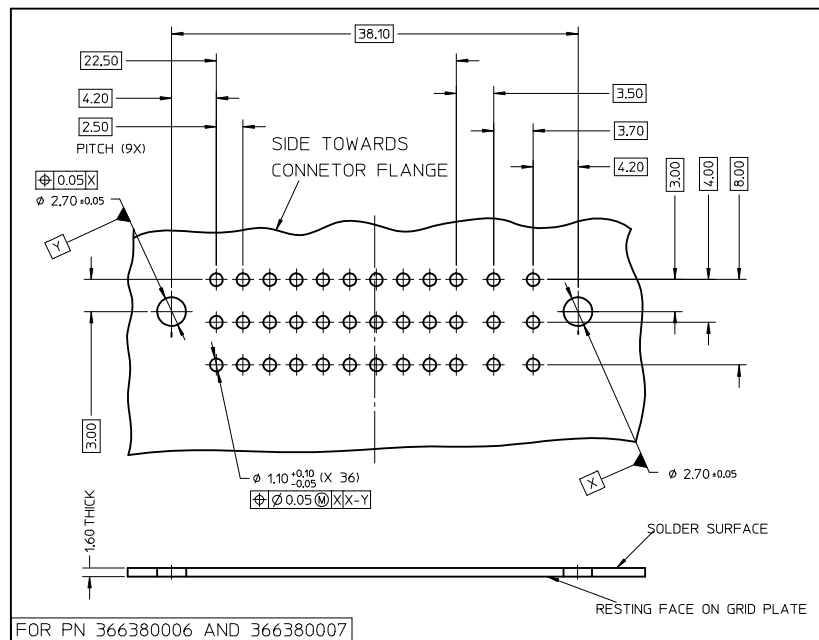
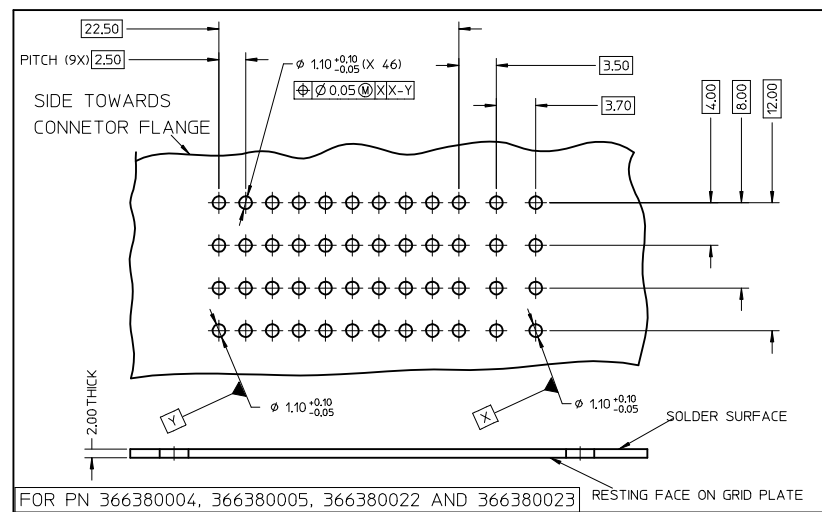
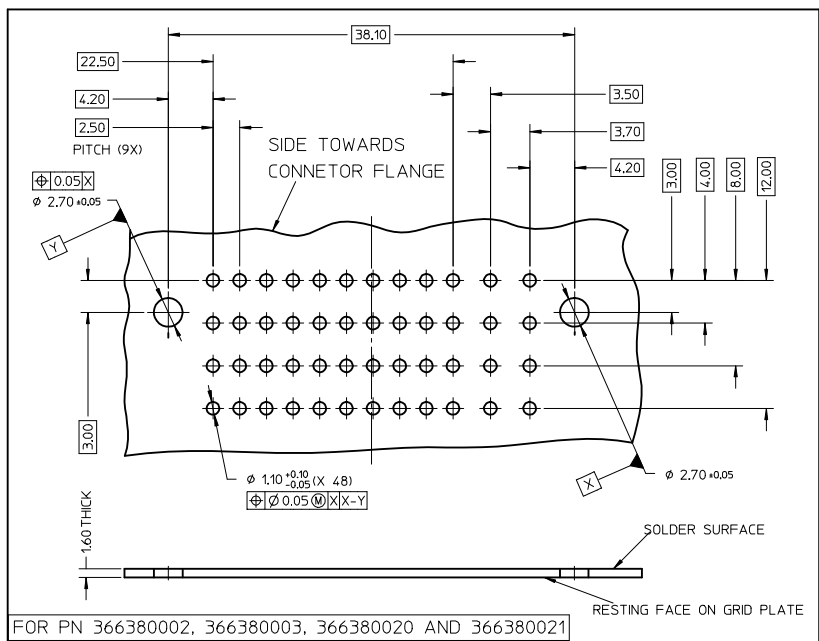

<b>ENTER DESCRIPTION</b> EC NO: 12013-0182 DRAWN: BR02 CHKD: APPR: KRASAD 2013/05/24 2013/06/06	QUALITY SYMBOLS ▽=0 ▽=0	GENERAL TOLERANCES (UNLESS SPECIFIED)		DIMENSION STYLE <b>MM ONLY</b>		SCALE <b>1:1</b>	DESIGN UNITS <b>METRIC</b>	THIRD ANGLE PROJECTION
		4 PLACES ± --- ± --- 3 PLACES ± --- ± --- 2 PLACES ± 0.1 ± --- 1 PLACE ± 0.2 ± --- ANGULAR ± 1°	mm INCH ± --- ± --- ± 0.1 ± --- ± 0.2 ± ---	DRAWN BY ROOPESH DATE 08/05/2006	CHECKED BY DINESH DATE 08/05/2006	TITLE <b>CMC HEADER                  48/48WAY AND 48/36WAY                  T3 INTERFACE</b>		
DRAFT WHERE APPLICABLE MUST REMAIN WITHIN DIMENSIONS	MATERIAL NO. <b>SEE TABLE 'A'</b>		APPROVED BY DINESH DATE 08/05/2006		MOLEX INCORPORATED DOCUMENT NO. <b>SD-36638-002</b>			
SIZE <b>A2</b>	THIS DRAWING CONTAINS INFORMATION THAT IS PROPRIETARY TO MOLEX INCORPORATED AND SHOULD NOT BE USED WITHOUT WRITTEN PERMISSION							SHEET NO. <b>3 OF 3</b>