

2 WAY RECEPTACLE

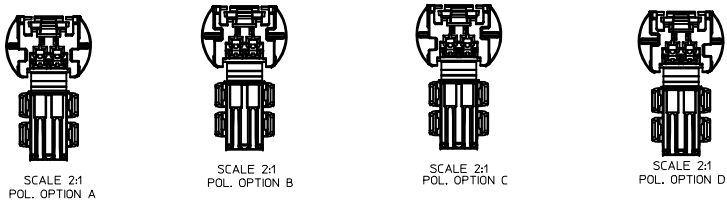

3 WAY RECEPTACLE

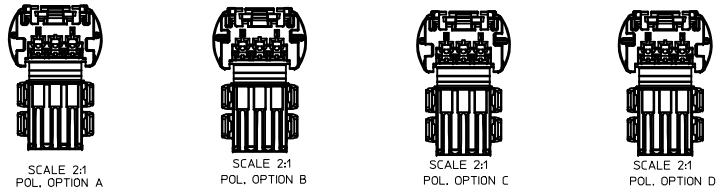

4 WAY RECEPTACLE

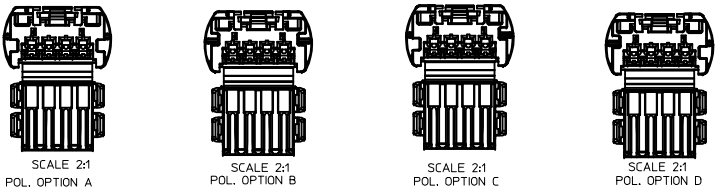

MX150 RECEPTACLE ASSEMBLIES

MATERIAL NUMBER BULK PACKAGING	CIRCUIT	POL	COLOR	MATING MALE CONNECTOR	
				/W GM CLIP	/W FORD CLIP
34796-0201	2	A	BLACK	34797-0201	34797-0205
34796-0202	2	B	NATURE	34797-0202	34797-0206
34796-0203	2	C	GRAY	34797-0203	34797-0207
34796-0204	2	D	DARK GRAY	34797-0204	34797-0208
34796-0301	3	A	BLACK	34797-0301	34797-0305
34796-0302	3	B	NATURE	34797-0302	34797-0306
34796-0303	3	C	GRAY	34797-0303	34797-0307
34796-0304	3	D	DARK GRAY	34797-0304	34797-0308
34796-0401	4	A	BLACK	34797-0401	34797-0405
34796-0402	4	B	NATURE	34797-0402	34797-0406
34796-0403	4	C	GRAY	34797-0403	34797-0407
34796-0404	4	D	DARK GRAY	34797-0404	34797-0408

MX150 RECEPTACLE TERMINALS

PART NUMBER		MATERIAL	WIRE GAGE		PLATING
DIRECTION B (RIGHT PAYOFF)	DIRECTION D (LEFT PAYOFF)		METRIC (mm#)	SAE (AWG#)	
LARGE POLARIZATION RIB					
33012-2021	33012-3021	COPPER ALLOY	1.50	14/16	TIN
33012-2022	33012-3022	COPPER ALLOY	1.0 - 0.75	18/20	TIN
33012-2023	33012-3023	COPPER ALLOY	0.50	22	TIN

\* NOBLE PLATING TERMINAL AND YAZAKI TERMINAL NOT LIST AT THE TABLE

NOTES: VALID UNLESS OTHERWISE SPECIFIED

1. GENERAL:
  - a. APPLICATION SPECIFICATION SEE: AS-34796-001
  - b. PRODUCT SPECIFICATION SEE: PS-34976-001
  - c. PACKAGING SPECIFICATION PER MOLEX DRAWING: PK-31301-695
  - d. PARTS MUST BE IN COMPLIANCE TO MOLEX CHEMICAL SUBSTANCES FOR PRODUCTS AND PACKAGING SPECIFICATION: PS-40000-5015
  - e. DATA MUST BE SUBMITTED UNDER THE MOLEX PART NUMBER TO IMDS (COMPANY ID#13255)
  - f. FLAMMABILITY REQUIREMENT: PER ISO3795 OR GM3191
    1. BURN RATE 100 mm/MIN MAXIMUM
    2. MATERIAL MUST BE SELF EXTINGUISHING
  - g. VISUAL DEFECTS SHALL MEET COSMETIC STANDARD PS-45499-002 (Class B)
  - h. PACKAGING: IN THE EVENT THAT THE PART IS FOUND DAMAGE DURING TRANSIT, REFER TO MOLEX SPECIFICATION PS-31301-865, AVAILABLE AT WWW.MOLEX.COM <HTTP://WWW.MOLEX.COM>
2. DESIGN - MATERIALS:
  - a. MATERIAL: UNFILLED PBT
3. DESIGN - GEOMETRY:
  - a. THIS IS A 100% CAD GENERATED PART. THE CAD MATHEMATICAL DATA IS THE MASTER FOR THIS PART. FOR DIMENSIONAL OR ANY INFORMATION NOT SHOWN ON THIS DRAWING, ANALYZE THE CAD MODEL.
  - b. GEOMETRIC DIMENSIONS AND TOLERANCES PER ASME Y14.5M - 1994
  - c. GENERAL TOLERANCES:
    - LINEAR: PLEASE SEE BELOW
    - ANGULAR: ±3°
  - d. EDGES AND UNDIMENSIONED DETAILS PER ISO13715
  - e. CORNERS SHOWN AS SHARP TO BE R 0.2 MAX
  - f. LETTERING SHALL BE 0.1 MAX RAISED IN 0.15 MAX RECESS PAD AND NOT PROTRUDE THE SURFACE. THIS INCLUDES RECYCLING CODE, PLANT AND CAVITY ID, VENDOR ID, CIRCUIT ID, AND PART SERIES NUMBER.

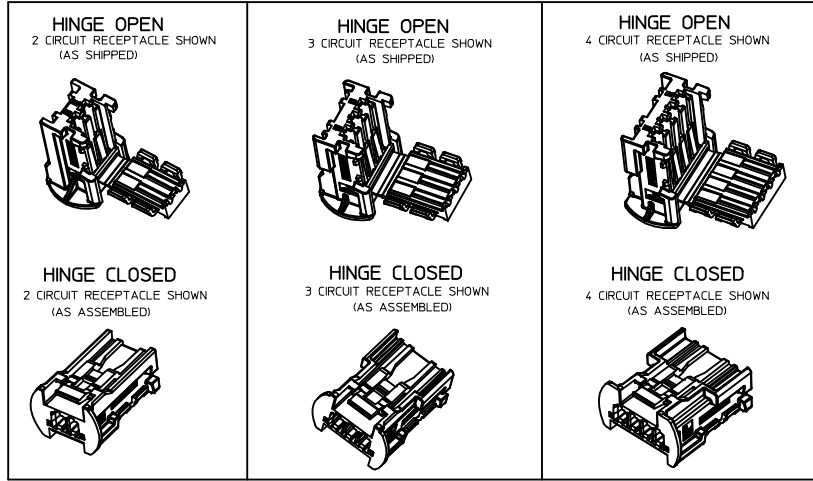

LAST BALLOON ON DRAWING:  
  
 DELETED BALLOONS:

INITIAL RELEASE EIC NO: GCA2014-0006 D: DRW: JBZHANG03 CHKD: APPR: CROU 2014/07/24	QUALITY SYMBOLS ∇=0 ∇=0 ∇=0	GENERAL TOLERANCES (UNLESS SPECIFIED) mm INCH 4 PLACES ± --- ± --- 3 PLACES ± 0.13 ± --- 2 PLACES ± 0.25 ± --- 1 PLACE ± 0.25 ± --- ANGULAR ± 3°	DIMENSION STYLE MM ONLY DRAWN BY DATE XBTANG 2010/12/31 CHECKED BY DATE JLOHMAN 2011/01/11 APPROVED BY DATE SMARCEAU 2011/06/27	SCALE 2:1 DESIGN UNITS METRIC THIRD ANGLE PROJECTION	TITLE MX150 ONE ROW UNSEAL FEMALE CONNECTOR
	DRAFT WHERE APPLICABLE MUST REMAIN WITHIN DIMENSIONS		MATERIAL NO. SEE TABLE DOCUMENT NO. SD-34796-001	MOLEX INCORPORATED	SHEET NO. 1 OF 2
	THIS DRAWING CONTAINS INFORMATION THAT IS PROPRIETARY TO MOLEX INCORPORATED AND SHOULD NOT BE USED WITHOUT WRITTEN PERMISSION				
	SIZE D				

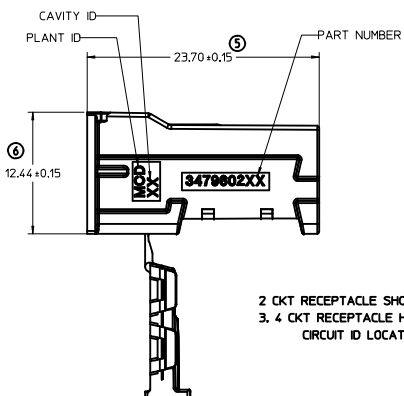
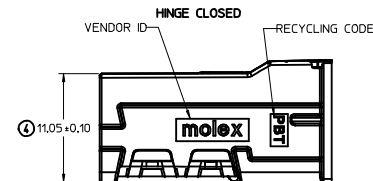
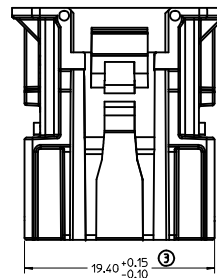
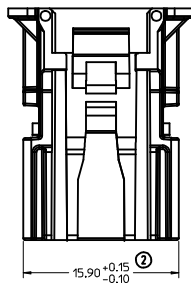
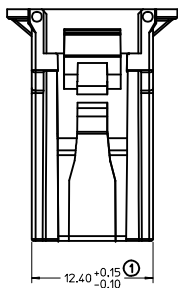

2 CKT RECEPTACLE SHOWN BELOW.  
3, 4 CKT RECEPTACLE HAS SIMILAR  
CIRCUIT ID LOCATION.

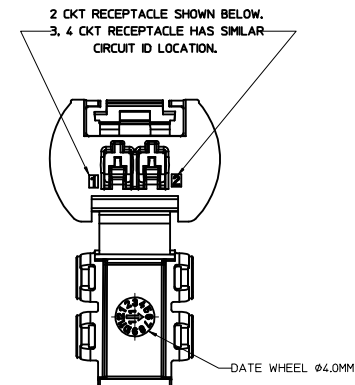
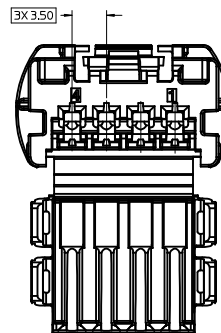
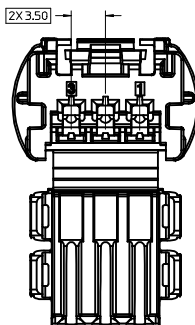
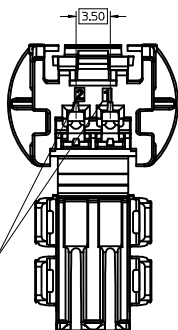

### PASS THRU DIAMETER INFORMATION

1 MM ADDITIONAL CLEARANCE ADDED TO TIGHTEST FIT CIRCLE  
(HINGE CLOSED)

PASS THRU DIAMETER  
(Ø19.4)

PASS THRU DIAMETER  
(Ø20.9)

PASS THRU DIAMETER  
(Ø22.0)

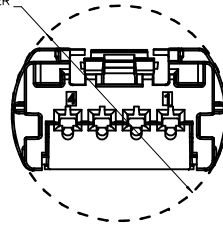
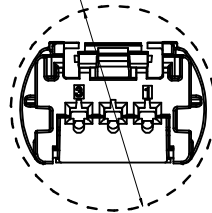
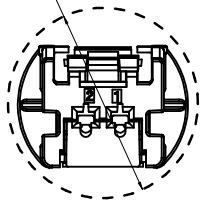

INITIAL RELEASE EC NO: GCA2014-0006 DRAWN: JBZHANG03 CHKD: APPR: CB01U 2014/07/17 2014/07/24	QUALITY SYMBOLS ∇=0 ∇=0 ∇=0	GENERAL TOLERANCES (UNLESS SPECIFIED)		DIMENSION STYLE MM ONLY	SCALE 4:1	DESIGN UNITS METRIC	THIRD ANGLE PROJECTION	
		4 PLACES ± --- ± ---	mm INCH	DRAWN BY XBTANG	DATE 2010/12/31	TITLE MX150 ONE ROW UNSEAL FEMALE CONNECTOR		
		3 PLACES ± --- ± ---		CHECKED BY JLOHMAN	DATE 2011/01/11	MOLEX INCORPORATED		
		2 PLACES ± 0.13 ± --- 1 PLACE ± 0.25 ± --- ANGULAR ± 3 °		APPROVED BY SMARCEAU	DATE 2011/06/27	MATERIAL NO. SEE TABLE	DOCUMENT NO. SD-34796-001	SHEET NO. 2 OF 2

DRAFT WHERE APPLICABLE  
MUST REMAIN  
WITHIN DIMENSIONS

THIS DRAWING CONTAINS INFORMATION THAT IS PROPRIETARY TO MOLEX  
INCORPORATED AND SHOULD NOT BE USED WITHOUT WRITTEN PERMISSION