

CLIFF

Cliffcon® 4 Pole Connectors



4PC/P/LV (FCR2066)



4PC/P/HV (FCR2067)



4PC/P90/LV (FCR20663)



4PC/P90/HV (FCR20673)



4PC/S/LV (FCR2068)



4PC/S/HV (FCR2069)

The **CLIFF® Cliffcon®** 4 pole connectors are intended for any application where a reliable locking touch proof connector system is required. Incorporating a tough, durable construction with gold plated touch proof contacts to IEC65, IEC348 and IEC1010-1, easy locking / unlocking mechanism and integral cable clamp, **Cliffcon®** is the ideal connector for many different applications. Receptacles are available for chassis, horizontal and vertical PCB mounting. Specific, non-compatible versions are designated for low (LV) and high (HV) voltage applications.

Significant features include:

- Safety leading ground pin - makes first, breaks last to prevent damage from arcing if disconnected under load.
- Combination FastOn® quick disconnect and screw / solder connections with clearly marked pin identification inside the line connectors.
- Color coded system - Blue for 120Vac, Red for 250Vac with different mechanical keying to avoid the possibility of intermating.
- Integral Cable Clamp for 6mm to 15mm diameter cable.
- Right Angle PCB Mounting Adapters available. (FCR6929)

Cliff Electronic Components, Ltd.
76 Holmethorpe Avenue, Holmethorpe Ind. Est.
Redhill, Surrey RH1 2PF. England
Tel: +44 (0) 1737 771375
Fax: +44 (0) 1737 766012
Email: sales@cliffuk.co.uk



Visit us online at:

www.cliffuk.co.uk

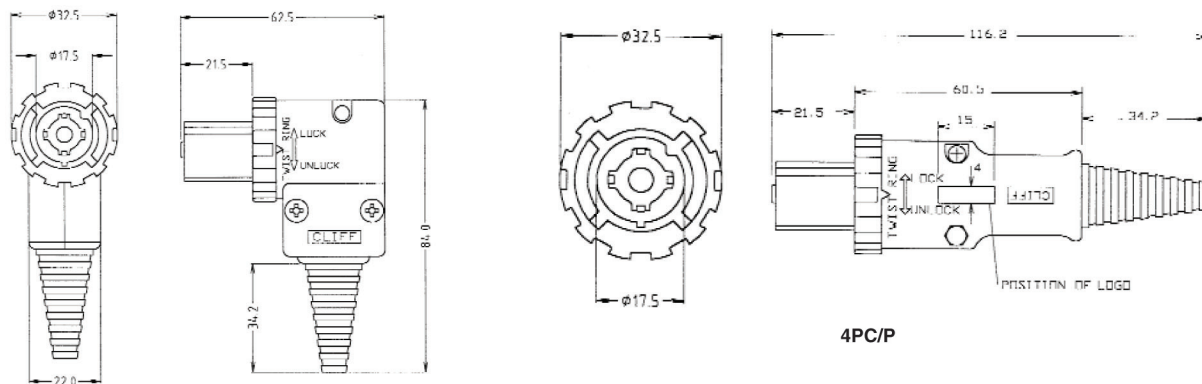

4PC/P90

4PC/P

HOLE OPTION
SUFFIX C
Ø3.40 HOLE
C/SK 80/82*
TO Ø5.20

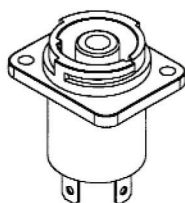

4PC/S

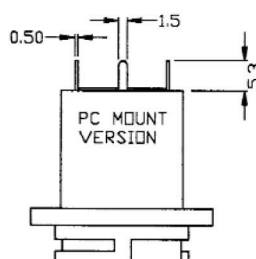
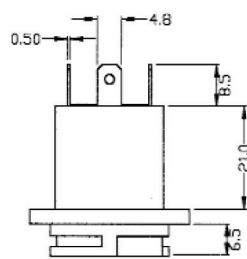

4PC/S/PC

PC LAYOUT
&
PANEL CUT OUT

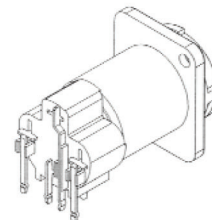
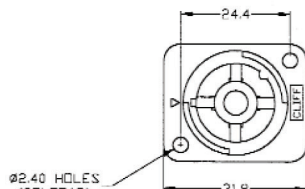
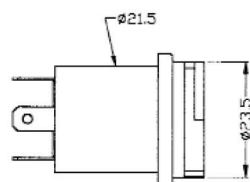
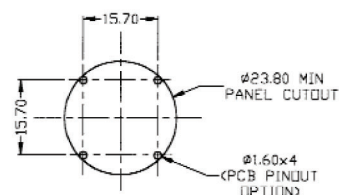

90° PCB ADAPTOR

Technical Data:

Rated Current: 4 pin 20A. RMS @ 80°C, 30A. RMS @ 20°C. (5% usage)

Rated Voltage: Blue (LV) 120V, Red (HV) 250V AC max.*

Contact Resistance New: < 3mΩ.

Capacitance between Terminals : <1.5pf.

Insulation Resistance: >20MΩ @ 4000V.

Inrush Current: >30A. / 20mS.

Operating Temperature: -20°C to +80°C

Recommended Wiring: 1+, 1- CH A (L) 2+, 2- CH B (R) Pin 1 designated for Earth. (+ Inphase, - Ground).

Contacts: Gold plated.

Max. Wire Size: 6mm² / 10AWG (solid) 4mm² / 12AWG (stranded).

*Connectors identical electrically, only the designation is LV and HV.