

5

4

3

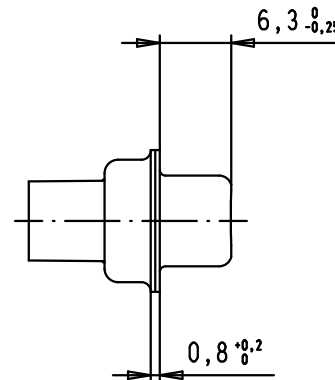
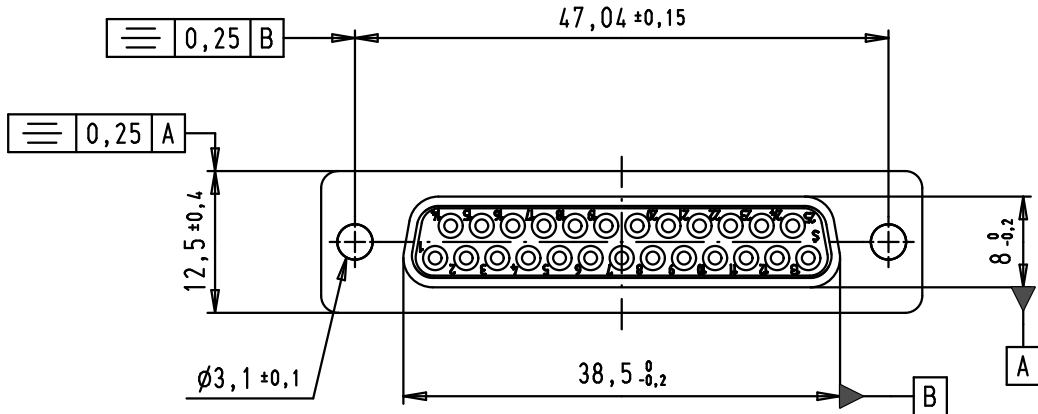

2

1

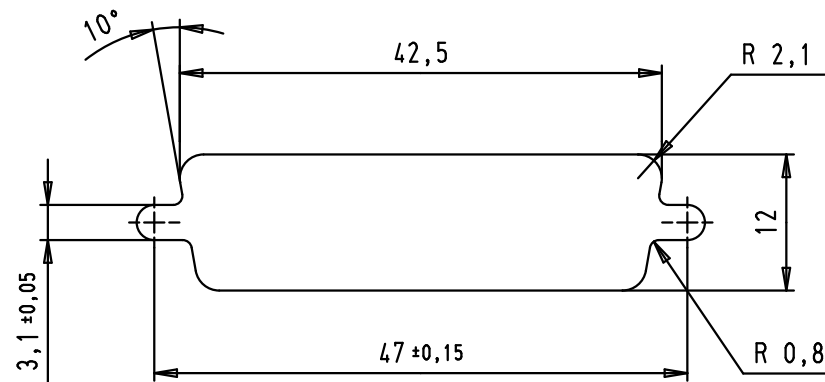
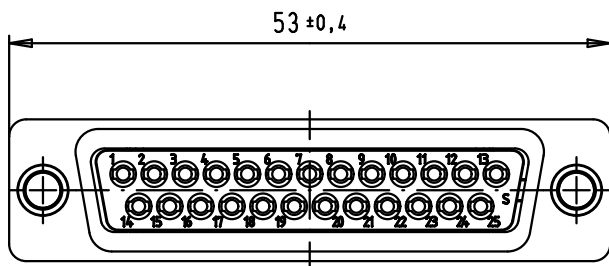

Panel cut out



Mod.	Dot.	Name	Detail.	Dot.	Name	 All Dim. in mm Orig. Size DIN A 4	D-Sub, female, straight, 25 poles, for crimp contacts AWG 20-24, tin plated shell	Maßstab/ Scale
34784	13/02/08	PK		09/04/02	CV			1,5:1
33106	22/09/05	JMDR	Insp.					
31571	12/11/03	SH	Stand.					
31526	31/07/03	TCP	HARTING EURL F-95972 Paris				TB 09 67 025 4701	Blatt/ Page
29768	09/04/02	CV						1 / 2
								Sub.

D

C

B

A