

FIBRE WASHER

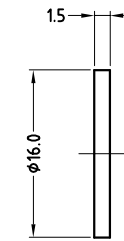

NUT OPTIONS

PLASTIC NUT

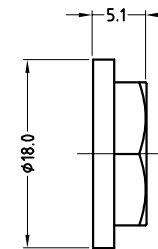

METAL NUT

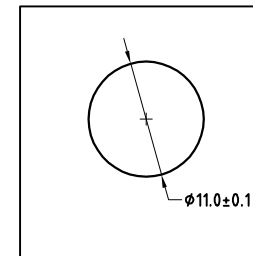
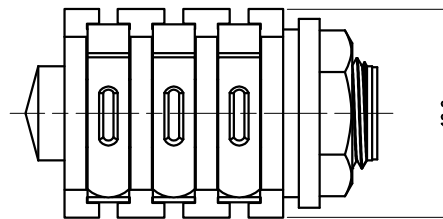
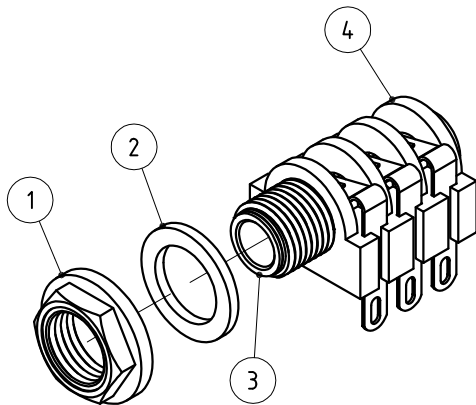
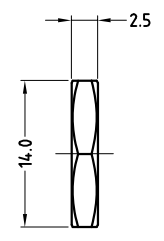

PANEL CUTOUT

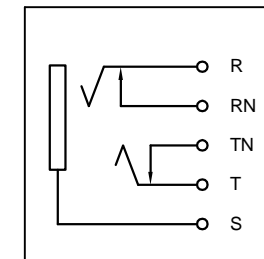

SCHEMATIC

ITEM	DESCRIPTION
1	METAL/PLASTIC NUT
2	FIBRE WASHER
3	METAL TUBE INSERT
4	CONNECTOR ASSEMBLY

PART No.	CATALOG No.	DESCRIPTION
55010293-000	ACJS-MHS	METAL NUT
55010293-001	ACJS-PHS	PLASTIC NUT

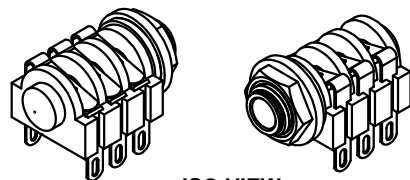

ISO VIEW

UNLESS OTHERWISE SPECIFIED TOLERANCE TO BE	
LINEAR	ANGULAR
X ± 0.5	X° ± 1°
X.X ± 0.1	X°X' ± 30'
X.XX ± 0.05	X°X'X" ± 15'

BREAK ALL SHARP EDGES AND REMOVE ALL BURRS

DO NOT SCALE

DIMENSIONS IN MILLIMETRES

THIS DOCUMENT IS THE PROPERTY OF AMPHENOL AUSTRALIA PTY. LTD.. NO PART THEREOF MAY BE REPRODUCED AND USED WITHOUT THE PRIOR WRITTEN CONSENT OF THE OWNER

CAD FILE: 55010293000111 DRN: L.V DATE: 27-02-04
 MATL: REFER TO COMPONENT CKD: M.N.H DATE: 13-01-06
 FINISH: REFER TO COMPONENT APP'D: P.M DATE: 13-01-06



SCALE: 2:1 UOS

REV.	CHANGE DETAILS	BY	DATE	CHG/No
1	CHANGE PART VARIATION NUMBER IN TABLE UPDATE DRAWING TO CURRENT PART	L.V	07-07-04	8293
0	FIRST ISSUE	L.V	27-02-04	----

TITLE: ACJS-MHS/ACJS-PHS 1/4" STEREO JACK CUSTOMER DRAWING		Amphenol	
DRAWING NO. 55010293-000-1		SHEET 1 OF 1	

Amphenol Australia Pty.Ltd, 2 Fireways Blvd, Keysborough, Vic3173