

10 9 8 7 6 5 4 3 2 1

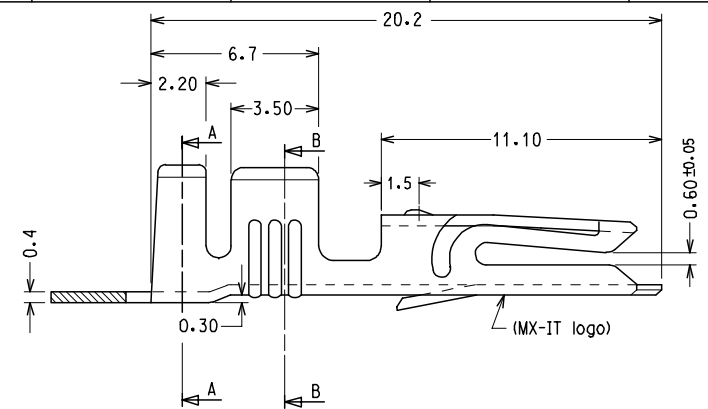

CODICE P/N	FINITURA PLATING	MATERIALE MATERIAL	SEZ. RAME WIRE RANGE	Ø ISOLANTE INS. RANGE	DIMENSIONI					PZ./BOBINA PCS/REEL
					A	B	C	D	E	
94518 - 0100	GREGGIO/ PLAIN	OTTONE BRASS	0.5 - 1.0	2.2 - 2.8	4.5	4.5	3.0	3.0	/	3000
94518 - 0101	STAGNATO/ TIN									
94518 - 0120	GREGGIO/ PLAIN	BRONZO FOSF. PHOSP.BRONZE	1.0 - 2.5	2.6 - 3.8	5.5	5.5	4.1	4.3	/	2500
94518 - 0121	STAGNATO/ TIN									
94518 - 0200	GREGGIO/ PLAIN	OTTONE BRASS	1.0 - 2.5	2.6 - 3.8	5.5	5.5	4.1	4.3	/	2500
94518 - 0201	STAGNATO/ TIN									
94518 - 0220	GREGGIO/ PLAIN	BRONZO FOSF. PHOSP.BRONZE	1.5 - 3.0	PER CAVI SINGOLI E DOPPI (VEDERE FOGLIO 2/2)	7.3	5.1	5.2	4.0	1.8	2500
94518 - 0221	STAGNATO/ TIN									
94518 - 0400	GREGGIO/ PLAIN	OTTONE BRASS	1.5 - 3.0	PER CAVI DOPPI (VEDERE FOGLIO 2/2)	7.3	5.1	5.2	4.0	1.8	2500
94518 - 0401	STAGNATO/ TIN									
94518 - 0300	GREGGIO/ PLAIN	OTTONE BRASS	4.0	3.4 - 3.7	5.5	5.5	5.0	5.1	/	2500
94518 - 0301	STAGNATO/ TIN									

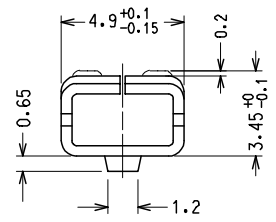
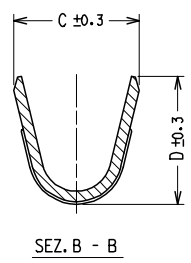
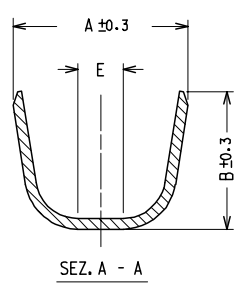
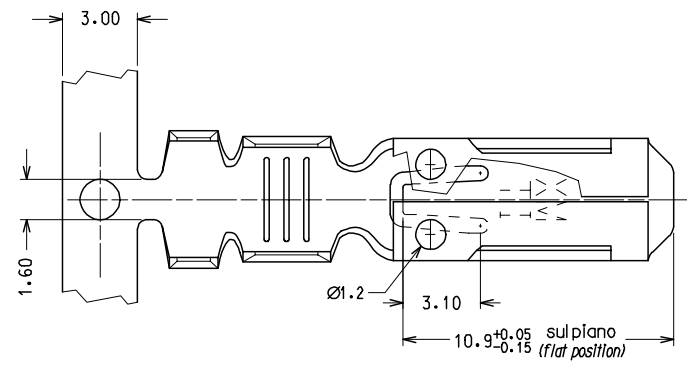

CONFEZIONE:
N° 5 bobine con carta intermedia per box.

PACKING:
N° 5 reels with Interleaf paper/box

Std. Descr.: HNF TERM (material-plating-wire range)

SENSO DI SVOLGIMENTO PER MINIAPPLICATORE
DIRECTION OFF REEL

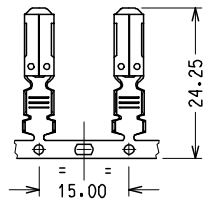
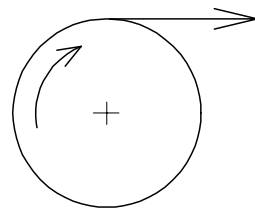

EC NO: Z2005-0129	2005/03/31	2005/03/31	2005/04/01
DRAWN:FGOTTARD	CHKD:RSANDANO	APP:GZUIN	DESCRIPTION

QUALITY SYMBOLS	▽=0	▽=0
-----------------	-----	-----

GENERAL TOLERANCES (UNLESS SPECIFIED)	
	mm INCH
4 PLACES	± --- ± ---
3 PLACES	± --- ± ---
2 PLACES	± 0.10 ± ---
1 PLACE	± 0.2 ± ---
ANGULAR ± 2 °	
DRAFT WHERE APPLICABLE MUST REMAIN WITHIN DIMENSIONS	

DIMENSION STYLE	
MM ONLY	
DRAWN BY	DATE
FGOTTARD	1992/10/01
CHECKED BY	DATE
APPROVED BY	DATE
MPREVIAT	1992/10/01
MATERIAL NO.	DOCUMENT NO.
SEE CHART	SD-94518-005

SCALE	DESIGN UNITS	FIRST ANGLE PROJECTION
5:1	METRIC	⊙ □
TITLE		
HNF FEMALE TERMINAL FOR 6.3 X 0.8 TABS		
MOLEX INCORPORATED		
DOCUMENT NO.		SHEET NO.
SD-94518-005		1 OF 1

9 8 7 6 5 4 3 2 1