

DIS. (DR.) M. SAMBRI
 CONT. (CHK) N. GALLETTO

DATA:
 21/04/05

REV. 0

SCALA NON IMPEGNATIVA
 DIMENSIONI IN mm

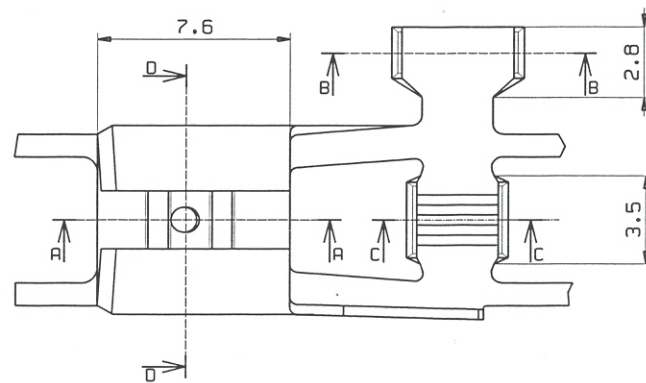
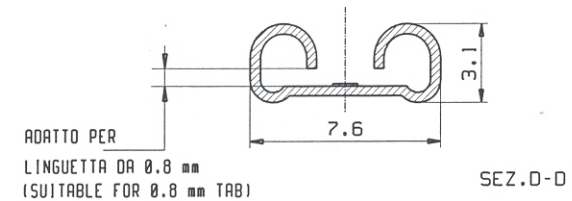
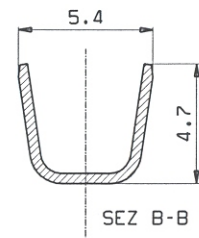
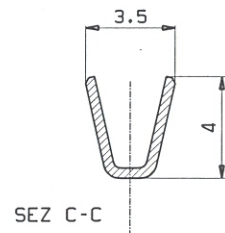
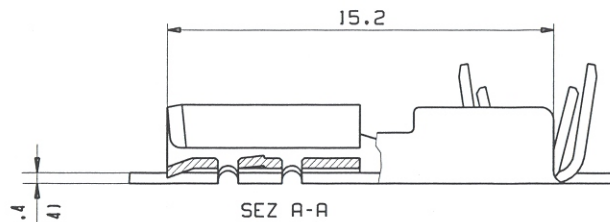

STATO DI FORNITURA IN BOBINA
 (SUPPLY CONDITION ON REEL)

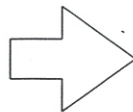
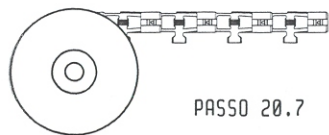

SENSO DI USCITA DEL TERMINALE
 DALLA BOBINA
 (DIRECTION OFF TOP OF REEL)

MATERIALE-FINITURA/CONFEZIONE (FINISH/MATERIAL/PACKING)	COD.IMP: (IMP P/No)
OTTONE GREGGIO SCIOLTO (BRASS-LOOSE PACKING)	683.08.00.9
OTTONE STAGNATO SCIOLTO (TIN PLTD BRASS-LOOSE PCK.)	683.08.01.9
OTTONE GREGGIO IN BOBINA (BRASS-REEL PACKING)	6835X.08.00.3
OTTONE STAGNATO IN BOBINA (TIN PLTD BRASS-REEL PCK.)	6835X.08.01.3
STAMPO N° (MOULD No) 62	N° PROGRESSIVO DISEGNO: (DRW N°) C1007
DISEGNO PER IL CLIENTE SOLO PER CODIFICA	CUSTOMER DWG. FOR REFERENCE ONLY
DIAM. ISOLANTE: (INS. DIA. RANGE) 2.5-4 mm	SEZ. FILO: (WIRE RANGE) 1-2.5 mmQ
TOLLERANZE, SE NON DIVERSAMENTE SPECIFICATO (TOLERANCES UNLESS OTHERWISE SPECIFIED) ± 0.3	I.M.P. I.W.P. di Narciso Galletto Via delle Scienze 20/A/1 45030 OCCHIOBELLO (RO)
ANGOLI (ANGLES) ± 2°	