

DIS. (DR.) N. SAMBRI
 CONT. (CHK) N. GALLETTO

DATA:
 03/11/17

REV. 0

SCALA NON IMPEGNATIVA
 DIMENSIONI IN mm



SEZ. D-D

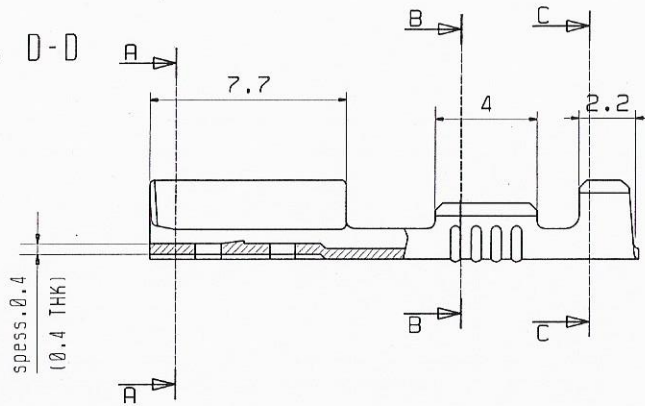

ADATTO PER
 LINGUETTA DA 0.8 mm
 (SUITABLE FOR 0.8 mm TAB)

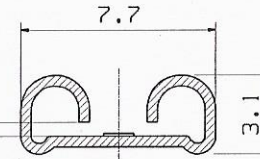

SEZ. A-A

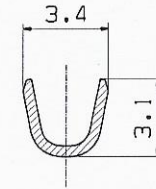

SEZ. C-C

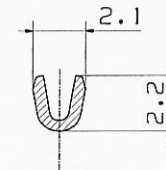

SEZ. B-B

PASSO: 21.4 mm

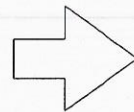
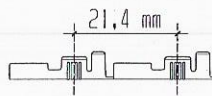
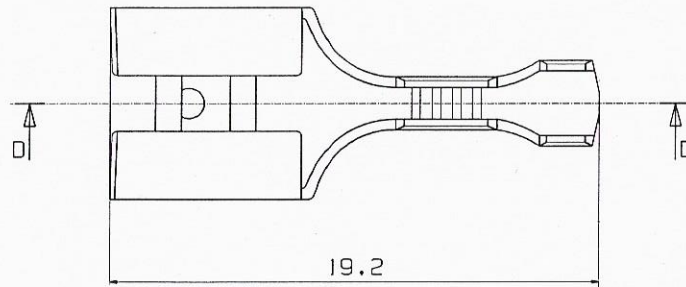

SENDO DI USCITA DEL TERMINALE
 DALLA BOBINA
 (DIRECTION OFF TOP OF REEL)

STATO DI FORNITURA: SOLO IN BOBINA
 (SUPPLY CONDITION: ON REEL ONLY)

MATERIALE/FINITURA (FINISH/MATERIAL)	COD.IMP: (IMP P/No)
OTTONE GREGGIO: (BRASS)	662.08.00.3
OTTONE STAGNATO (TIN PLTD BRASS)	662.08.01.3
STAMPO N° 137	N° PROGRESSIVO DISEGNO: (DRW N°) C1282
DISEGNO PER IL CLIENTE SOLO PER CODIFICA	CUSTOMER DWG. FOR REFERENCE ONLY
SEZ. FILO: (WIRE RANGE) 0.2-0.5 mmq - 24-20 AWG	Ø ISOLANTE: (INS. DIA. RANGE) 1.2-2.1 mm
TOLLERANZE, SE NON DIVERSAMENTE SPECIFICATO (TOLERANCES UNLESS OTHERWISE SPECIFIED)	± 0.3
ANGOLI (ANGLES)	± 2°
I.M.P. Group	
Via delle Scienze 20/A/I 45030 OCCHIOBELLO (RO)	